



# Artix™ ESB

---

## Security Guide

Version 5.0, July 2007

IONA Technologies PLC and/or its subsidiaries may have patents, patent applications, trademarks, copyrights, or other intellectual property rights covering subject matter in this publication. Except as expressly provided in any written license agreement from IONA Technologies PLC, the furnishing of this publication does not give you any license to these patents, trademarks, copyrights, or other intellectual property. Any rights not expressly granted herein are reserved.

IONA, IONA Technologies, the IONA logos, Orbix, Artix, Making Software Work Together, Adaptive Runtime Technology, Orbacus, IONA University, and IONA XMLBus are trademarks or registered trademarks of IONA Technologies PLC and/or its subsidiaries.

Java and J2EE are trademarks or registered trademarks of Sun Microsystems, Inc. in the United States and other countries. CORBA is a trademark or registered trademark of the Object Management Group, Inc. in the United States and other countries. All other trademarks that appear herein are the property of their respective owners.

This product includes software developed by the OpenSSL Project for use in the OpenSSL Toolkit (<http://www.openssl.org>).

This product includes cryptographic software written by Eric Young ([eay@cryptsoft.com](mailto:eay@cryptsoft.com))

This product includes software written by Tim Hudson ([tjh@cryptsoft.com](mailto:tjh@cryptsoft.com)).

IONA Technologies PLC makes no warranty of any kind to this material including, but not limited to, the implied warranties of merchantability and fitness for a particular purpose. IONA Technologies PLC shall not be liable for errors contained herein, or for incidental or consequential damages in connection with the furnishing, performance or use of this material.

---

#### COPYRIGHT NOTICE

No part of this publication may be reproduced, stored in a retrieval system or transmitted, in any form or by any means, photocopying, recording or otherwise, without prior written consent of IONA Technologies PLC. No third party intellectual property right liability is assumed with respect to the use of the information contained herein. IONA Technologies PLC assumes no responsibility for errors or omissions contained in this book. This publication and features described herein are subject to change without notice.

Copyright © 2001-2007 IONA Technologies PLC. All rights reserved.

All products or services mentioned in this manual are covered by the trademarks, service marks, or product names as designated by the companies who market those products.

Updated: August 17, 2007

# Contents

<b>List of Tables</b>	<b>13</b>
<b>List of Figures</b>	<b>15</b>
<b>Preface</b>	<b>19</b>
<b>What is Covered in This Book</b>	<b>19</b>
<b>Who Should Read This Book</b>	<b>19</b>
<b>The Artix Documentation Library</b>	<b>19</b>
<b>Part I Introduction to Security</b>	
<b>Chapter 1 Getting Started with Artix Security</b>	<b>23</b>
<b>Secure SOAP Demonstration—Java Runtime</b>	<b>24</b>
Secure Hello World Example	25
Client-to-Server Connection	28
Server-to-Security Server Connection	33
Security Layer	41
<b>Secure SOAP Demonstration—C++ Runtime</b>	<b>47</b>
Secure Hello World Example	48
HTTPS Connection	51
IIOP/TLS Connection	55
Security Layer	62
<b>Secure Container Demonstration</b>	<b>68</b>
<b>Debugging with the openssl Utility</b>	<b>75</b>
<b>Chapter 2 Introduction to the Artix Security Framework</b>	<b>81</b>
<b>Artix Security Architecture</b>	<b>82</b>
Types of Security Credential	83
Protocol Layers	85
Security Layer	87
Using Multiple Bindings	88

Caching of Credentials—C++ Runtime	89
<b>Chapter 3 Security for HTTP-Compatible Bindings</b>	<b>91</b>
Overview of HTTP Security	92
Securing HTTP Communications with TLS—Java Runtime	95
Securing HTTP Communications with TLS—C++ Runtime	103
HTTP Basic Authentication—C++ Runtime	114
X.509 Certificate-Based Authentication—Java Runtime	118
X.509 Certificate-Based Authentication—C++ Runtime	123
<b>Chapter 4 Security for SOAP Bindings</b>	<b>129</b>
Overview of SOAP Security	130
WSS X.509 Certificates and Authentication—C++ Runtime	135
<b>Chapter 5 Security for CORBA Bindings</b>	<b>139</b>
Overview of CORBA Security	140
Securing IIOP Communications with SSL/TLS	142
Securing Two-Tier CORBA Systems with CSI—C++ Runtime	148
Securing Three-Tier CORBA Systems with CSI—C++ Runtime	154
X.509 Certificate-Based Authentication for CORBA Bindings—C++ Runtime	161
<b>Part II TLS Security Layer</b>	
<b>Chapter 6 Managing Certificates</b>	<b>171</b>
What are X.509 Certificates?	172
<b>Certification Authorities</b>	<b>174</b>
Commercial Certification Authorities	175
Private Certification Authorities	176
<b>Certificate Chaining</b>	<b>177</b>
<b>PKCS#12 Files</b>	<b>179</b>
<b>Creating Your Own Certificates</b>	<b>181</b>
Set Up Your Own CA	182
Use the CA to Create Signed PKCS#12 Certificates	185
Use the CA to Create Signed Certificates in a Java Keystore	188
<b>Generating a Certificate Revocation List</b>	<b>191</b>

<b>Chapter 7 Configuring HTTPS and IOP/TLS Authentication</b>	<b>195</b>
<b>Requiring Authentication</b>	<b>196</b>
Target-Only Authentication	197
Mutual Authentication	201
<b>Specifying Trusted CA Certificates</b>	<b>206</b>
Specifying Trusted CA Certificates for HTTPS—Java Runtime	207
Specifying Trusted CA Certificates for HTTPS—C++ Runtime	209
Specifying Trusted CA Certificates for IOP/TLS	214
<b>Specifying an Application's Own Certificate</b>	<b>216</b>
Deploying Own Certificate for HTTPS—Java Runtime	217
Deploying Own Certificate for HTTPS—C++ Runtime	219
Deploying Own Certificate for IOP/TLS	223
<b>Specifying a Certificate Revocation List</b>	<b>225</b>
<b>Advanced Configuration Options</b>	<b>228</b>
Setting a Maximum Certificate Chain Length—C++ Runtime	229
Applying Constraints to Certificates—C++ Runtime	230
<b>Chapter 8 Configuring HTTPS Cipher Suites—Java Runtime</b>	<b>233</b>
Supported Cipher Suites	234
Cipher Suite Filters	236
SSL/TLS Protocol Version	239
<b>Chapter 9 Configuring Secure Associations</b>	<b>241</b>
Overview of Secure Associations	242
<b>Setting Association Options</b>	<b>244</b>
Secure Invocation Policies	245
Association Options	247
Choosing Client Behavior	249
Choosing Target Behavior	251
Hints for Setting Association Options	253
<b>Specifying Cipher Suites</b>	<b>257</b>
Supported Cipher Suites	258
Setting the Mechanism Policy	261
Constraints Imposed on Cipher Suites	264
<b>Caching Sessions</b>	<b>267</b>

## Part III The Artix Security Service

<b>Chapter 10</b>	<b>Configuring the Artix Security Service</b>	<b>271</b>
	<b>Configuring the Security Service</b>	<b>272</b>
	Security Service Accessible through IOP/TLS	<b>273</b>
	Security Service Accessible through HTTPS	<b>282</b>
	<b>Configuring the File Adapter</b>	<b>293</b>
	<b>Configuring the LDAP Adapter</b>	<b>295</b>
	<b>Configuring the Kerberos Adapter</b>	<b>301</b>
	Overview of Kerberos Configuration	<b>302</b>
	Configuring the KDC Connection	<b>305</b>
	Configuring the Active Directory Connection	<b>308</b>
	Sample Kerberos Configuration	<b>311</b>
	<b>Clustering and Federation</b>	<b>313</b>
	Federating the Artix Security Service	<b>314</b>
	Failover—C++ Runtime	<b>319</b>
	Client Load Balancing—C++ Runtime	<b>327</b>
	<b>Additional Security Configuration</b>	<b>330</b>
	Configuring Single Sign-On Properties	<b>331</b>
	Configuring the Log4J Logging	<b>333</b>
<b>Chapter 11</b>	<b>Managing Users, Roles and Domains</b>	<b>335</b>
	<b>Introduction to Domains and Realms</b>	<b>336</b>
	Artix security domains	<b>337</b>
	Artix Authorization Realms	<b>339</b>
	<b>Managing a File Security Domain</b>	<b>344</b>
	<b>Managing an LDAP Security Domain</b>	<b>349</b>
<b>Chapter 12</b>	<b>Managing Access Control Lists</b>	<b>351</b>
	<b>Overview of Artix ACL Files</b>	<b>352</b>
	<b>ACL File Format</b>	<b>353</b>
	<b>Generating ACL Files</b>	<b>357</b>
	<b>Deploying ACL Files</b>	<b>360</b>
<b>Chapter 13</b>	<b>Configuring Servers to Support Authentication—Java Runtime</b>	<b>363</b>
	<b>Connecting to the Artix Security Service</b>	<b>364</b>
	<b>Selecting Credentials to Authenticate</b>	<b>369</b>

<b>Chapter 14</b>	<b>Configuring the Artix Security Plug-In—C++ Runtime</b>	<b>379</b>
	The Artix Security Plug-In	380
	Configuring an Artix Configuration File	381
	Configuring a WSDL Contract	383
<b>Part IV Artix Security Features</b>		
<b>Chapter 15</b>	<b>Single Sign-On</b>	<b>389</b>
	SSO and the Login Service	390
	Username/Password-Based SSO for SOAP Bindings—Java Runtime	393
	Username/Password-Based SSO for SOAP Bindings—C++ Runtime	407
<b>Chapter 16</b>	<b>Publishing WSDL Securely—C++ Runtime</b>	<b>419</b>
	Introduction to the WSDL Publish Plug-In	420
	Deploying WSDL Publish in a Container	423
	Preprocessing Published WSDL Contracts	427
	Enabling SSL/TLS for WSDL Publish Plug-In	428
<b>Chapter 17</b>	<b>Partial Message Protection—C++ Runtime</b>	<b>433</b>
	Introduction to SOAP PMP	434
	Setting Up a Java Keystore	438
	Artix Configuration	445
	Policy Configuration	449
	Introduction to Policy Configuration	450
	Action Definitions	452
	Action Properties	459
	Protection Policy Definitions	463
	Conditions	467
	Example of WSS Signing and Encryption	470
	Basic Signing and Encryption Scenario	471
	Configuring the Client	473
	Configuring the Server	478
	Exception Handling	483
<b>Chapter 18</b>	<b>Principal Propagation—C++ Runtime</b>	<b>485</b>
	Introduction to Principal Propagation	486

<b>Configuring</b>	<b>487</b>
<b>Programming</b>	<b>490</b>
<b>Interoperating with .NET</b>	<b>493</b>
Explicitly Declaring the Principal Header	<b>494</b>
Modifying the SOAP Header	<b>496</b>
<b>Chapter 19 Bridging between SOAP and CORBA—C++ Runtime</b>	<b>499</b>
<b>SOAP-to-CORBA Scenario</b>	<b>500</b>
Overview of the Secure SOAP-to-CORBA Scenario	<b>501</b>
SOAP Client	<b>503</b>
SOAP-to-CORBA Router	<b>507</b>
CORBA Server	<b>513</b>
<b>Single Sign-On SOAP-to-CORBA Scenario</b>	<b>516</b>
Overview of the Secure SSO SOAP-to-CORBA Scenario	<b>517</b>
SSO SOAP Client	<b>519</b>
SSO SOAP-to-CORBA Router	<b>521</b>
<b>CORBA-to-SOAP Scenario</b>	<b>523</b>
Overview of the Secure CORBA-to-SOAP Scenario	<b>524</b>
CORBA Client	<b>526</b>
CORBA-to-SOAP Router	<b>528</b>
SOAP Server	<b>534</b>
<b>Part V Programming Security</b>	
<b>Chapter 20 Programming Authentication—C++ Runtime</b>	<b>539</b>
<b>Configuration for SOAP 1.2 Bindings</b>	<b>540</b>
<b>Propagating a Username/Password Token</b>	<b>541</b>
<b>Propagating a Kerberos Token</b>	<b>546</b>
<b>Propagating an X.509 Certificate</b>	<b>551</b>
<b>Chapter 21 Programming Authentication—Java Runtime</b>	<b>557</b>
<b>The Security Credentials Model</b>	<b>558</b>
<b>Creating and Sending Credentials</b>	<b>564</b>
<b>Retrieving Received Credentials</b>	<b>569</b>
<b>Endorsements</b>	<b>575</b>



<b>Chapter 22</b>	<b>Developing an iSF Adapter</b>	<b>579</b>
	iSF Security Architecture	580
	iSF Server Module Deployment Options	584
	iSF Adapter Overview	586
	Implementing the IS2Adapter Interface	587
	Deploying the Adapter	597
	Configuring iSF to Load the Adapter	598
	Setting the Adapter Properties	599
	Loading the Adapter Class and Associated Resource Files	600
<b>Appendix A</b>	<b>Artix Security</b>	<b>603</b>
	Applying Constraints to Certificates	605
	bus:initial_contract	607
	bus:security	608
	initial_references	610
	password_retrieval_mechanism	612
	plugins:asp	613
	plugins:at_http	616
	plugins:atli2_tls	621
	plugins:csi	622
	plugins:gsp	623
	plugins:https	628
	plugins:iiop_tls	629
	plugins:java_server	633
	plugins:kdm	636
	plugins:kdm_adm	638
	plugins:login_client	639
	plugins:login_service	640
	plugins:schannel	641
	plugins:security	642
	plugins:wSDL_publish	645
	plugins:wss	646
	policies	648
	policies:asp	655
	policies:bindings	658
	policies:csi	660
	policies:external_token_issuer	663
	policies:https	664

policies:iiop_tls	667
policies:security_server	677
policies:soap:security	679
principal_sponsor	680
principal_sponsor:csi	684
principal_sponsor:http	687
principal_sponsor:https	689
principal_sponsor:iioptls	691
principal_sponsor:wsse	693
<b>Appendix B iSF Configuration</b>	<b>697</b>
Properties File Syntax	698
iSF Properties File	699
Cluster Properties File	725
log4j Properties File	728
<b>Appendix C ASN.1 and Distinguished Names</b>	<b>731</b>
ASN.1	732
Distinguished Names	733
<b>Appendix D Action-Role Mapping DTD</b>	<b>737</b>
<b>Appendix E OpenSSL Utilities</b>	<b>743</b>
<b>Using OpenSSL Utilities</b>	<b>744</b>
The x509 Utility	745
The req Utility	747
The rsa Utility	749
The ca Utility	751
The s_client Utility	753
The s_server Utility	755
<b>The OpenSSL Configuration File</b>	<b>758</b>
[req] Variables	759
[ca] Variables	760
[policy] Variables	761
Example openssl.cnf File	762

<b>Appendix F</b>	<b>Configuring the Java Runtime CORBA Binding</b>	<b>765</b>
	Java Runtime CORBA Binding Architecture	766
	Bootstrapping the Configuration	768
<b>Appendix G</b>	<b>License Issues</b>	<b>773</b>
	OpenSSL License	774
<b>Index</b>		<b>777</b>

## CONTENTS

# List of Tables

Table 1: Namespaces Used for Configuring Cipher Suite Filters	236
Table 2: SSL/TLS Protocols Supported by SUN's JSSE Provider	239
Table 3: Description of Different Types of Association Option	253
Table 4: Setting EstablishTrustInTarget and EstablishTrustInClient Association Options	254
Table 5: Setting Quality of Protection Association Options	255
Table 6: Setting the NoProtection Association Option	256
Table 7: Cipher Suite Definitions	259
Table 8: Association Options Supported by Cipher Suites	265
Table 9: LDAP Properties in the com.iona.isp.adapter.LDAP.param Scope	299
Table 10: The Artix Security Plug-In Configuration Variables	381
Table 11: <bus-security:security> Attributes	383
Table 12: Properties of an Action Definition	459
Table 13: Condition Properties	467
Table 14: Standard WSS Fault Codes	484
Table 15: IONA Proprietary Fault Codes	484
Table 16: Combinations of Security Protocol and Credential Type	559
Table 17: Parameters for createOutCredential()	565
Table 18: Mechanism Policy Cipher Suites	651
Table 19: Mechanism Policy Cipher Suites	665
Table 20: Mechanism Policy Cipher Suites	671
Table 21: Commonly Used Attribute Types	734

## LIST OF TABLES

# List of Figures

Figure 1: Overview of the Secure HelloWorld Example	25
Figure 2: A HTTPS Connection in the HelloWorld Example	28
Figure 3: HTTPS Connection to the Artix Security Service	33
Figure 4: The Security Layer in the HelloWorld Example	41
Figure 5: Overview of the Secure HelloWorld Example	48
Figure 6: A HTTPS Connection in the HelloWorld Example	51
Figure 7: An IIOP/TLS Connection in the HelloWorld Example	55
Figure 8: The Security Layer in the HelloWorld Example	62
Figure 9: Connecting to a Secure Container Service	68
Figure 10: Protocol Layers in a HTTP-Compatible Binding	85
Figure 11: Protocol Layers in a SOAP Binding	86
Figure 12: Protocol Layers in a CORBA Binding	86
Figure 13: Example of an Application with Multiple Bindings	88
Figure 14: HTTP-Compatible Binding Security Layers	92
Figure 15: Overview of Certificate-Based Authentication with HTTPS—Java Runtime	119
Figure 16: Overview of Certificate-Based Authentication with HTTPS	124
Figure 17: Overview of Security for SOAP Bindings	130
Figure 18: Overview of Certificate-Based Authentication with WSS	135
Figure 19: A Secure CORBA Application within the Artix Security Framework	140
Figure 20: Two-Tier CORBA System Using CSI Credentials	148
Figure 21: Three-Tier CORBA System Using CSIV2	154
Figure 22: Overview of Certificate-Based Authentication	162
Figure 23: A Certificate Chain of Depth 2	177
Figure 24: A Certificate Chain of Depth 3	178
Figure 25: Elements in a PKCS#12 File	179
Figure 26: Target Authentication Only	197

## LIST OF FIGURES

Figure 27: Mutual Authentication	201
Figure 28: Configuration of a Secure Association	243
Figure 29: Constraining the List of Cipher Suites	264
Figure 30: An iSF Federation Scenario	315
Figure 31: Failover Scenario for a Cluster of Three Security Services	320
Figure 32: Architecture of an Artix security domain	337
Figure 33: Server View of Artix authorization realms	340
Figure 34: Role View of Artix authorization realms	341
Figure 35: Assignment of Realms and Roles to Users Janet and John	342
Figure 36: Locally Deployed Action-Role Mapping ACL File	352
Figure 37: Overview of Connecting to the Security Service	364
Figure 38: Configuring Authentication and Authorization in an Artix Server	369
Figure 39: Client Requesting an SSO Token from the Login Service	391
Figure 40: Overview of Username/Password Authentication without SSO	393
Figure 41: Overview of Username/Password Authentication with SSO	394
Figure 42: Overview of Username/Password Authentication without SSO	407
Figure 43: Overview of Username/Password Authentication with SSO	408
Figure 44: Endpoints Used by the WSDL Publishing Service	420
Figure 45: WSDL Publish Plug-In Deployed in a Secure Container	423
Figure 46: HTML Page Served Up by the WSDL Publishing Service	431
Figure 47: Basic Client-Server Scenario	435
Figure 48: Overview of Keystores for a Client-Server Application	440
Figure 49: Basic Signing and Encryption Scenario	471
Figure 50: Propagating Credentials Across a SOAP-to-CORBA Router	501
Figure 51: Propagating an SSO Token Across a SOAP-to-CORBA Router	517
Figure 52: Propagating Credentials Across a CORBA-to-SOAP Router	524
Figure 53: Artix Credential API	559
Figure 54: Multiple Credentials in an OutCredentialsMap	562
Figure 55: Multiple Credentials in an InCredentialsMap	563



Figure 56: Overview of the Artix Security Service	581
Figure 57: iSF Server Module Deployed as a CORBA Service	584
Figure 58: iSF Server Module Deployed as a Java Library	585
Figure 59: Java Runtime CORBA Binding Architecture	766

## LIST OF FIGURES

# Preface

## **What is Covered in This Book**

This book describes how to develop and configure secure Artix solutions.

## **Who Should Read This Book**

This book is aimed at the following kinds of reader: security administrators, C++ programmers who need to write security code and Java programmers who need to write security code.

If you would like to know more about WSDL concepts, see the Introduction to WSDL in [Getting Started with Artix](#).

## **The Artix Documentation Library**

For information on the organization of the Artix library, the document conventions used, and where to find additional resources, see [Using the Artix Library](#)



# Part I

## Introduction to Security

---

### In this part

This part contains the following chapters:

<a href="#">Getting Started with Artix Security</a>	page 23
<a href="#">Introduction to the Artix Security Framework</a>	page 81
<a href="#">Security for HTTP-Compatible Bindings</a>	page 91
<a href="#">Security for SOAP Bindings</a>	page 129
<a href="#">Security for CORBA Bindings</a>	page 139



# Getting Started with Artix Security

*This chapter introduces features of Artix security by explaining the architecture and configuration of the secure HelloWorld demonstration in some detail.*

---

## **In this chapter**

This chapter discusses the following topics:

<a href="#">Secure SOAP Demonstration—Java Runtime</a>	<a href="#">page 24</a>
<a href="#">Secure SOAP Demonstration—C++ Runtime</a>	<a href="#">page 47</a>
<a href="#">Secure Container Demonstration</a>	<a href="#">page 68</a>
<a href="#">Debugging with the openssl Utility</a>	<a href="#">page 75</a>

---

# Secure SOAP Demonstration—Java Runtime

---

## Overview

This section provides an overview of how the *Artix security framework* provides security for a simple SOAP/HTTPS client-server application. The Artix security framework is a comprehensive security framework that supports authentication and authorization using data stored in a central security service (the Artix security service). This discussion is illustrated by the secure HelloWorld demonstration located in the `java/samples/security/authorization` directory.

---

## In this section

This section contains the following subsections:

<a href="#">Secure Hello World Example</a>	<a href="#">page 25</a>
<a href="#">Client-to-Server Connection</a>	<a href="#">page 28</a>
<a href="#">Server-to-Security Server Connection</a>	<a href="#">page 33</a>
<a href="#">Security Layer</a>	<a href="#">page 41</a>



# Secure Hello World Example

## Overview

This section provides an overview of the secure HelloWorld demonstration for the Java runtime, which introduces several features of the Artix Security Framework. In particular, this demonstration shows you how to configure a typical Artix client and server that communicate with each other using a SOAP binding over a HTTPS transport. Figure 1 shows all the parts of the secure HelloWorld system, including the various configuration files.

Figure 1: Overview of the Secure HelloWorld Example

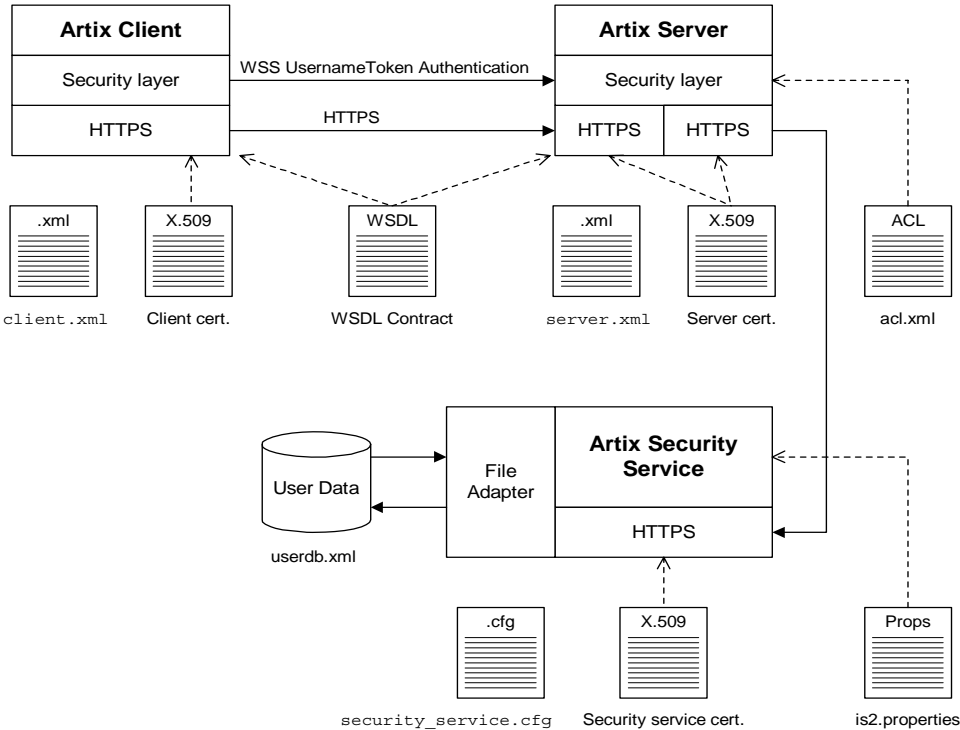

---

**Location** The secure HelloWorld demonstration for the Java runtime is located in the following directory:

```
ArtixInstallDir/java/samples/security/authorization
```

---

**Main elements of the example** The main elements of the secure HelloWorld example shown in [Figure 1](#) are, as follows:

- [HelloWorld client](#).
- [HelloWorld server](#).
- [Artix security service](#).
- [File adapter](#).

---

**HelloWorld client** The HelloWorld client communicates with the HelloWorld server using SOAP over HTTPS, thus providing confidentiality for transmitted data. In addition, the HelloWorld client is programmed to use WSS UsernameToken authentication to transmit a username and a password to the server.

---

**HelloWorld server** The HelloWorld server accepts a SOAP/HTTPS connection from the client and, in order to perform security checks on the requests received from the client, the server also opens a secure connection to the Artix security service. The connection between the server and the Artix security service also employs the SOAP/HTTPS protocol.

---

**Artix security service** The Artix security service manages a central repository of security-related user data. The Artix security service can be accessed remotely by Artix servers and offers the service of authenticating users and retrieving authorization data.

---

**File adapter** The Artix security service supports a number of adapters that can be used to integrate with third-party security products (for example, an LDAP adapter is available). This example uses the *iSF file adapter*, which is a simple adapter provided for demonstration purposes.

**Note:** The file adapter is a simple adapter that does *not* scale well for large enterprise applications. IONA supports the use of the file adapter in a production environment, but the number of users is limited to 200.

---

**Security layers**

To facilitate the discussion of the HelloWorld security infrastructure, it is helpful to analyze the security features into the following layers:

- [HTTPS layer](#).
  - [Security layer](#).
- 

**HTTPS layer**

The HTTPS layer provides a secure transport layer for SOAP bindings. In the Artix Java runtime, the HTTPS transport is configured by editing XML configuration files (for example, `client.xml` and `server.xml`).

For more details, see [“Client-to-Server Connection” on page 28](#).

---

**Security layer**

The security layer provides support for a simple username/password authentication mechanism, a principal authentication mechanism and support for authorization. A security administrator can edit an *action-role mapping file* to restrict user access to particular WSDL port types and operations.

For more details, see [“Security Layer” on page 41](#).

## Client-to-Server Connection

### Overview

Figure 2 shows an overview of the HelloWorld example, focusing on the elements relevant to the HTTPS connection between the Artix client and the Artix server.

**Figure 2:** A HTTPS Connection in the HelloWorld Example

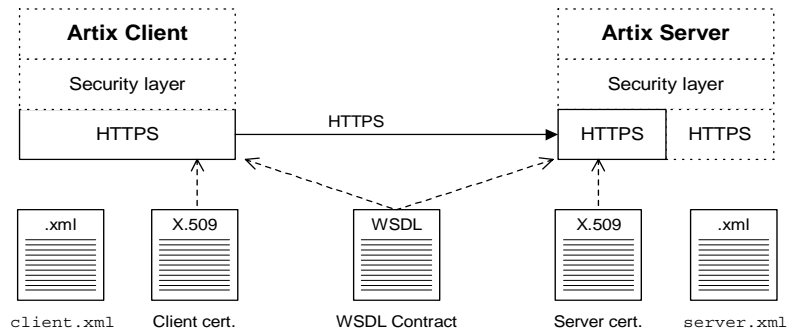

### Mutual authentication

The HelloWorld example is configured to use *mutual authentication* on the client-to-server HTTPS connection. That is, during the TLS handshake, the server authenticates itself to the client (using an X.509 certificate) and the client authenticates itself to the server. Hence, both the client and the server require their own X.509 certificates.

**Note:** You can also configure your application to use *target-only authentication*, where the client does not require an own X.509 certificate. See [“Requiring Authentication” on page 196](#) for details.

## Enabling HTTPS

To enable HTTPS, you must ensure that the URL identifying the service endpoint in the WSDL contract has the `https:` prefix. For example, the HelloWorld service specifies a SOAP over HTTPS endpoint in the `hello_world.wsdl` file as follows:

```
<wsdl:definitions name="HelloWorld"
  targetNamespace="http://apache.org/hello_world_soap_http"
  xmlns:soap="http://schemas.xmlsoap.org/wsdl/soap/"
  xmlns:wSDL="http://schemas.xmlsoap.org/wsdl/" ... >
  ...
  <wsdl:service name="SOAPService">
    <wsdl:port binding="tns:Greeter_SOAPBinding"
      name="SoapPort">
      <soap:address
        location="https://localhost:9001/SoapContext/SoapPort"/>
      </wsdl:port>
    </wsdl:service>
  </wsdl:definitions>
```

In addition, you must ensure that the server `main()` method is programmed to publish the `https` URL. For example:

```
// Java
public class Server {
  ...
  public static void main(String args[]) throws Exception {
    Object implementor = new GreeterImpl();
    String address =
      "https://localhost:9001/SoapContext/SoapPort";
    Endpoint.publish(address, implementor);
    ...
  }
}
```

## Client HTTPS configuration

[Example 1](#) shows how to configure the client side of an HTTPS connection, in the case of mutual authentication.

### Example 1: Client HTTPS Configuration—Java Runtime

```
<beans
  xmlns="http://www.springframework.org/schema/beans"
  xmlns:http="http://cxf.apache.org/transport/http/configuration"
  xmlns:sec="http://cxf.apache.org/configuration/security"
```

**Example 1:** *Client HTTPS Configuration—Java Runtime*

```

xmlns:xsi="http://www.w3.org/2001/XMLSchema-instance"
... >
1   <http:conduit
   name="{http://apache.org/hello_world_soap_http}SoapPort.http-
   conduit">
2     <http:tlsClientParameters>
3       <sec:keyManagers keyPassword="password">
         <sec:keyStore type="jks"
           resource="keys/localhost.jks"
           password="password"/>
4       </sec:keyManagers>
5       <sec:trustManagers>
         <sec:keyStore type="jks"
           resource="keys/truststore.jks"
           password="password"/>
         </sec:trustManagers>
       </http:tlsClientParameters>
     </http:conduit>
  </beans>

```

The preceding configuration can be explained as follows:

1. The following configuration settings are applied to the WSDL port with the QName, {http://apache.org/hello\_world\_soap\_http}SoapPort.
2. The `sec:keyManagers` element is used to attach an X.509 certificate and private key to the client. The password specified by the `keyPassword` attribute is used to decrypt the certificate's private key.
3. The `sec:keyStore` element is used to specify an X.509 certificate and private key that are stored in Java keystore format. The `password` attribute specifies the password required to access the `keys/localhost.jks` keystore. It is expected that the keystore file contains just one key entry, so there is no need to specify a key alias.
4. The `sec:trustManagers` element is used to specify a list of trusted CA certificates (the client uses this list to decide whether or not to trust certificates received from the server side).
5. The `resource` attribute of the `sec:keyStore` element specifies a Java keystore file, `truststore.jks`, containing one or more trusted CA certificates. The `password` attribute specifies the password required to access the keystore.

**Server HTTPS configuration**

**Example 2** shows how to configure the server side of an HTTPS connection, in the case of mutual authentication.

**Example 2:** *Server HTTPS Configuration—Java Runtime*

```

<beans xmlns="http://www.springframework.org/schema/beans"
xmlns:xsi="http://www.w3.org/2001/XMLSchema-instance"
xmlns:http="http://cxf.apache.org/transport/http/configuration"
xmlns:httpj="http://cxf.apache.org/transport/http-jetty/configuration"
xmlns:jaxws="http://cxf.apache.org/jaxws"
xmlns:sec="http://cxf.apache.org/configuration/security"
xmlns:security="http://cxf.ionac.com/security/rt/configuration"
... >
...
<httpj:engine-factory bus="cxf">
1  <httpj:engine port="9001">
2  <httpj:tlsServerParameters>
3  <sec:keyManagers keyPassword="password">
4  <sec:keyStore type="JKS" password="password"
5  file="keys/localhost.jks"/>
6  </sec:keyManagers>
7  <sec:trustManagers>
8  <sec:keyStore type="JKS" password="password"
9  file="keys/truststore.jks"/>
10 </sec:trustManagers>
11 <sec:cipherSuitesFilter>
12 <sec:include>.*_WITH_3DES_.*</sec:include>
13 <sec:include>.*_WITH_DES_.*</sec:include>
14 <sec:exclude>.*_WITH_NULL_.*</sec:exclude>
15 <sec:exclude>.*_DH_anon_.*</sec:exclude>
16 </sec:cipherSuitesFilter>
17 <sec:clientAuthentication want="true"
18 required="true"/>
19 </httpj:tlsServerParameters>
20 </httpj:engine>
21 </httpj:engine-factory>
</beans>

```

The preceding configuration can be explained as follows:

1. The `httpj:engine-factory` element configures *all* of the WSDL ports that share the IP port, `9001`, to have the same TLS security settings (it is inherently impossible for different WSDL ports to have different TLS settings, if they share the same IP port).
2. The `sec:keyManagers` element is used to attach an X.509 certificate and private key to the server. The password specified by the `keyPassword` attribute is used to decrypt the certificate's private key.
3. The `sec:keyStore` element is used to specify an X.509 certificate and private key that are stored in Java keystore format. It is expected that the keystore file contains just one key entry, so there is no need to specify a key alias.
4. The `sec:trustManagers` element is used to specify a list of trusted CA certificates (the server uses this list to decide whether or not to trust certificates presented by clients).
5. The `resource` attribute of the `sec:keyStore` element specifies a Java keystore file, `truststore.jks`, containing one or more trusted CA certificates. The `password` attribute specifies the password required to access the keystore.
6. The `sec:cipherSuitesFilter` element can be used to narrow the choice of cipher suites that the server is willing to use for a TLS connection. See [“Configuring HTTPS Cipher Suites—Java Runtime” on page 233](#) for details.
7. The `sec:clientAuthentication` element determines the server's disposition towards the presentation of client certificates. The settings shown here configure the server to require mutual authentication (that is, the client *must* present an X.509 certificate).



# Server-to-Security Server Connection

## Overview

Figure 3 shows an overview of the HelloWorld example, focusing on the elements relevant to the HTTPS connection between the Artix server and the Artix security service. In general, the Artix security service is accessible either through the HTTPS or through the IIOPTLS transport.

Figure 3: HTTPS Connection to the Artix Security Service

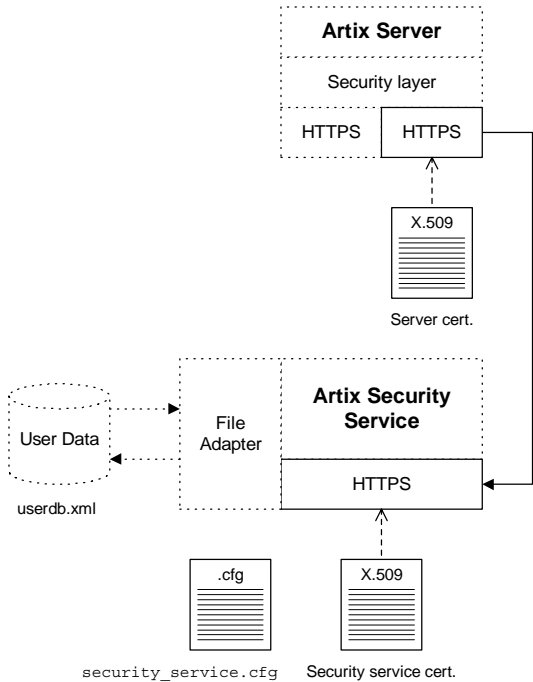

**Artix server HTTPS configuration**

The Artix server's HTTPS transport is configured by the settings in the `ArtixInstallDir/java/samples/security/authorization/etc/server.xml` file. You need to configure the Artix server so that it acts as a HTTPS *client* of the Artix security service. [Example 3](#) shows an extract from the `server.xml` file, showing the settings required to configure the client side of the server-to-security service link.

**Example 3:** *Server's HTTPS Link to the Security Service*

```

<beans xmlns="http://www.springframework.org/schema/beans"
       xmlns:xsi="http://www.w3.org/2001/XMLSchema-instance"

       xmlns:http="http://cxf.apache.org/transports/http/configuration"
       xmlns:httpj="http://cxf.apache.org/transports/http-jetty/configuration"
       xmlns:jaxws="http://cxf.apache.org/jaxws"
       xmlns:sec="http://cxf.apache.org/configuration/security"
       xmlns:security="http://schemas.ionac.com/soa/security-config"
       xsi:schemaLocation="...">
    ...
    1 <security:IsfClientConfig
    2     id="it.soa.security"
    3     IsfServiceWsdLoc="file:etc/isf_service.wsdl"
    />

    4 <http:conduit
       name="{http://schemas.ionac.com/idl/isf_service.idl}IT_ISF.ServiceManagerSOAPPort.http-conduit">
       <http:tlsClientParameters>
    5         <sec:keyManagers keyPassword="password">
           <sec:keyStore type="jks"
                       password="password"
                       resource="keys/isf-client.jks"/>
        </sec:keyManagers>
    6         <sec:trustManagers>
           <sec:keyStore type="jks"
                       password="password"
                       file="keys/isf-client.jks"/>
        </sec:trustManagers>
       </http:tlsClientParameters>
       </http:conduit>
    7 <http:conduit
       name="{http://schemas.ionac.com/idl/isfx_authn_service.idl}IT_ISFX.AuthenticationServiceSOAPPort.http-conduit">

```

**Example 3:** Server's HTTPS Link to the Security Service

```

<http:tlsClientParameters>
  <sec:keyManagers keyPassword="password">
    <sec:keyStore type="jks"
      password="password"
      resource="keys/isf-client.jks"/>
  </sec:keyManagers>
  <sec:trustManagers>
    <sec:keyStore type="jks"
      password="password"
      file="keys/isf-client.jks"/>
  </sec:trustManagers>
</http:tlsClientParameters>
</http:conduit>
...
</beans>

```

The preceding XML configuration can be explained as follows:

1. The `security:IsfClientConfig` element is used to configure the handler that opens a connection to the Artix security service.
2. This `id` attribute must be set as shown. This is a technical requirement in order to identify the element internally.
3. The `IsfServiceWsdLLoc` attribute specifies the location of the WSDL contract for the Artix security service. The WSDL contract provides the address URL for contacting the Artix security service (see [“Artix security service WSDL contract”](#) on page 36).
4. The following client configuration settings are applied to the *service manager* port on the Artix security service, which has the QName, `{http://schemas.iona.com/idl/isf_service.idl}IT_ISF.ServiceManagerSOAPPort`. The service manager service is responsible for bootstrapping connections to the other WSDL services hosted by the Artix security service. In particular, the service manager is used here to bootstrap a connection to the *authentication service*.
5. The `sec:keyManagers` element is used to attach an X.509 certificate and private key to the service manager conduit.

**Note:** The `isf-client.jks` keystore contains a single key entry (accessed by the `keyManagers` element) and a single truststore entry (accessed by the `trustManagers` element).

6. The `sec:trustManagers` element is used to specify a list of trusted CA certificates (the security handler uses this list to decide whether or not to trust certificates received from the Artix security service during the SSL/TLS handshake).
7. The client configuration settings contained in this `http:conduit` element are applied to the *authentication service* port on the Artix security service, which has the QName, `{http://schemas.iona.com/idl/isfx_authn_service.idl}IT_ISFX.AuthenticationServiceSOAPPort`. The authentication service provides the service of authenticating credentials on behalf of the Artix server.

### Artix security service WSDL contract

Example 4 shows an extract from the Artix security service WSDL contract, which is located in the file `ArtixInstallDir/java/samples/security/authorization/etc/isf_service.wsdl`.

#### Example 4: Artix Security Service WSDL Contract

```
<definitions name="isf_service"
  targetNamespace="http://schemas.iona.com/idl/isf_service.idl"
  xmlns="http://schemas.xmlsoap.org/wsdl/"
  xmlns:http="http://schemas.xmlsoap.org/wsdl/http/"
  xmlns:soap="http://schemas.xmlsoap.org/wsdl/soap/"
  xmlns:tns="http://schemas.iona.com/idl/isf_service.idl"
  ... >
  ...
  <service name="IT_ISF.ServiceManagerSOAPService">
    <port binding="tns:IT_ISF.ServiceManagerSOAPBinding"
      name="IT_ISF.ServiceManagerSOAPPort">
      <http:address
        location="https://localhost:59075/services/security/ServiceMa
        nager"/>
      </port>
    </service>
  </definitions>
```

The most important feature of the WSDL contract is the HTTP address of the service manager service (as highlighted in [Example 4](#)). Normally, you would edit the address URL, replacing the IP address, `localhost:59075`, with the actual host and IP port where you want to run the Artix security service.

**Note:** Although the Artix security service contains multiple WSDL services, you only need to specify an address for the service manager service. The other security-related services are automatically obtained by querying the service manager service.

### Artix security service HTTPS configuration

[Example 5](#) shows an extract from the `security_service.cfg` file, highlighting the HTTPS settings that are important for the Artix security service.

#### Example 5: Artix Security Service HTTPS Configuration

```

1 include "../../../../../cxx_java/etc/domains/artix.cfg";

security_service
{
    ...
    #
    # Event logging
    #
2   event_log:filters = ["IT_SECURITY=WARN+ERROR+FATAL",
3   "IT_JAVA_SERVER=*"];
    plugins:local_log_stream:filename = "isf.log";
    #
    # Configuration of the Java plugin to the Iona Generic
    Server container
4   generic_server_plugin = "java_server";
    plugins:java_server:shlib_name = "it_java_server";
5   plugins:java_server:class =
    "com.iona.jbus.security.services.SecurityServer";
    plugins:java_server:classpath =
6   "../../../../../cxx_java/lib/artix/security_service/5.0/secu
    rity_service-rt.jar";
    plugins:java_server:system_properties =
    ["org.omg.CORBA.ORBClass=com.iona.corba.art.artimpl.ORBImpl",
    "org.omg.CORBA.ORBSingletonClass=com.iona.corba.art.artimpl.O
    RBSingleton", "is2.properties=is2.properties",
    "java.endorsed.dirs=../../../../../cxx_java/lib/endorsed"];

```

**Example 5:** *Artix Security Service HTTPS Configuration*

```

plugins:java_server:jni_verbose = "false";
plugins:java_server:X_options = ["rs"];
...
bus
{
    # Bus plugins for Artix services
7   orb_plugins = ["local_log_stream", "java",
"wsdl_publish"];
8   java_plugins= ["isf"];
9   bus:initial_contract:url:isf_service =
"isf_service.wsdl";
    # TLS settings for Artix services
10  plugins:at_http:server:use_secure_sockets="true";
11  plugins:at_http:server:server_certificate =
"..../keys/isf-server.p12";
    plugins:at_http:server:server_private_key_password =
"administratorpass";
12  plugins:at_http:server:trusted_root_certificates =
"..../keys/isf-trustdb.pem";
13  policies:target_secure_invocation_policy:requires =
["Confidentiality", "Integrity", "DetectMisordering",
"DetectReplay", "EstablishTrustInClient"];
    # Certificate constraints on inbound requests
14  policies:certificate_constraints_policy = ["CN=*"];
};
};

```

The preceding Artix configuration file can be explained as follows:

1. The included `artix.cfg` configuration file contains some generic configuration and settings for security.
2. If you comment out this line, the event log filter would default to the settings inherited from the `cxx_java/etc/domains/artix.cfg` file. To disable the event log completely (for example, in order to improve performance of the security service), initialize the event log with an empty list. For example:

```
event_log:filters = [];
```

3. The `plugins:local_log_stream:filename` specifies the location of the security service's log file.

4. The following lines configure the *Artix generic server*.  
The core of the Artix security service is implemented as a pure Java program, which gets loaded into the Artix generic server.
5. The `plugins:java_server:class` setting specifies the entry point for the Java implementation of the security service. Currently, there are two possible entry points:
  - ◆ `com.iona.jbus.security.services.SecurityServer`—this entry point is suitable for running a HTTPS-based security service (it initializes both a HTTPS port and an IIOP/TLS port). The detailed configuration of the HTTPS transport appears inside the `bus` configuration sub-scope.
  - ◆ `com.iona.corba.security.services.SecurityServer`—this entry point is suitable for running an IIOP/TLS-based security service (it initializes an IIOP/TLS port only). See [“Security Service Accessible through IIOP/TLS” on page 273](#) for details.
6. This line sets the system properties for the Java implementation of the security service. In particular, the `is2.properties` property specifies the location of a properties file, which contains further property settings for the Artix security service.
7. The `orb_plugins` list in the bus scope must include the following plug-ins:
  - ◆ `java plug-in`—enables the Artix Java plug-in mechanism, which can then be loaded using the `java_plugins` list.
  - ◆ `wSDL_publish plug-in`—loads the WSDL publishing service, which enables clients of the security service to download WSDL contracts. In order to access some of the security service’s interfaces, the client must download the relevant WSDL contracts through the publishing service.
8. The `java_plugins` list lets you load Artix Java plug-ins (see *JAX-RPC Programmer’s Guide* for more details) and in this case a single plug-in, `isf`, is loaded. The `isf` plug-in is responsible for exposing the security service core as an Artix service.  
The `plugins:isf:classname` variable specifies the entry point for the implementation of the `isf` plug-in.

9. This setting specifies the location of the security service's WSDL contract. You will generally need to edit this WSDL contract, to specify the security service's host and port.
10. This setting ensures that the security service and the WSDL publishing service accept incoming connections only over HTTPS, instead of insecure HTTP, and implicitly causes the `https` plug-in to load.
11. This line specifies the X.509 certificate that the security server presents to incoming HTTPS connections during an SSL/TLS handshake.
12. If the client presents a certificate to the security service, Artix checks to make sure that the client certificate is signed by one of the CAs in the trusted CA list specified here.
13. The specified target secure invocation policy includes the `EstablishTrustInClient` association option, which ensures that the security service accepts connections *only* from clients that present an X.509 certificate.
14. The HTTPS-based security service supports a primitive form of access control, whereby client certificates are rejected unless they conform to the constraints specified in `policies:certificate_constraints_policy`.

For details of how to specify certificate constraints, see [“Applying Constraints to Certificates” on page 605](#).

**Note:** The `policies:certificate_constraints_policy` setting is fundamentally important for securing the security service. This is the only mechanism (apart from checking the certificate's signature) that the security service can use to restrict access to itself.



# Security Layer

## Overview

Figure 4 shows an overview of the HelloWorld example, focusing on the elements relevant to the security layer. The security layer, in general, takes care of those aspects of security that arise *after* the initial SSL/TLS handshake has occurred and the secure connection has been set up.

Figure 4: The Security Layer in the HelloWorld Example

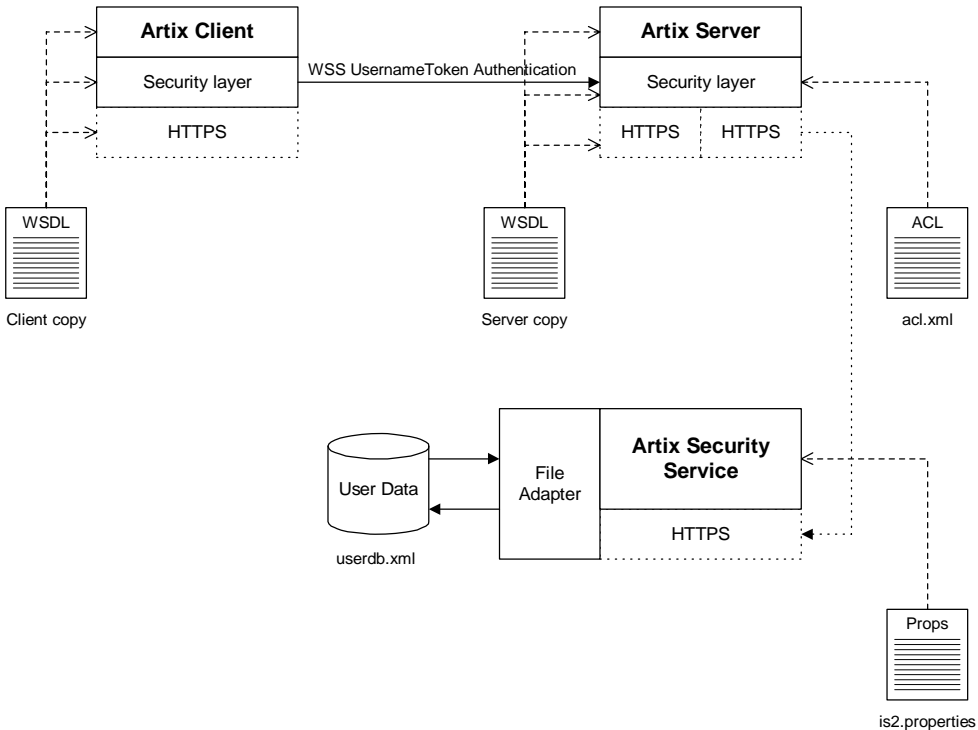

The security layer normally uses a simple username/password combination for authentication. The username and password are sent along with every operation, enabling the Artix server to check every invocation and make fine-grained access decisions.

## WSS UsernameToken authentication

---

The mechanism that the Artix client uses to transmit a username and password over a SOAP binding is *WSS UsernameToken authentication*. This is a standard SOAP login mechanism that functions by sending a username and password combination inside a SOAP header. On its own, WSS UsernameToken login would be relatively insecure, because the username and password would be transmitted in plaintext. When combined with the HTTPS protocol, however, the username and password are transmitted securely over an encrypted connection, thus preventing eavesdropping.

You can specify the WSS username and password by programming the client through the *Java runtime credential API*. For details of the required coding steps, see [“Creating and Sending Credentials” on page 564](#).

---

## Authentication through the iSF file adapter

On the server side, the Artix server delegates authentication to the Artix security service, which acts as a central repository for user data. The Artix security service is configured by the `is2.properties` file, whose location is specified in the `security_service.cfg` file as follows:

```
# Artix Configuration File (security_service.cfg)
include "../../../../../etc/domains/artix.cfg";

security_service {
    ...
    plugins:java_server:system_properties =
["org.omg.CORBA.ORBClass=com.ion.corba.art.artimpl.ORBImpl",
"org.omg.CORBA.ORBSingletonClass=com.ion.corba.art.artimpl.ORBSingleton",
"is2.properties=ArtixInstallDir/java/samples/security/authorization/etc/is2.properties",
"java.endorsed.dirs=../artix-5.0/cxx_java/lib/endorsed"];
    ...
};
```

In this example, the `is2.properties` file specifies that the Artix security service should use a file adapter. The file adapter is configured as follows:

```
# is2.properties File
com.iona.isp.adapters=file
...
#####
##
## File Adapter Properties
##
#####
com.iona.isp.adapter.file.class=com.iona.security.is2adapter.file.FileAuthAdapter
com.iona.isp.adapter.file.params=filename
com.iona.isp.adapter.file.param.filename=userdb.xml
```

The `com.iona.isp.adapter.file.param.filename` property is used to specify the location of a file, `userdb.xml`, which contains the user data for the iSF file adapter. [Example 6](#) shows the contents of the user data file for the secure HelloWorld demonstration.

**Example 6:** *User Data from the `userdb.xml` File*

```
<?xml version="1.0" encoding="utf-8" ?>
<ns:securityInfo xmlns:ns="urn:www-xmlbus-com:simple-security">
  <users>
    <user name="alice" password="passw0rd">
      <realm name="IONAGlobalRealm">
        <role name="guest"/>
      </realm>
      <realm name="corporate">
        <role name="president"/>
      </realm>
    </user>
    <user name="bob" password="passw0rd">
      <realm name="IONAGlobalRealm">
        <role name="guest"/>
      </realm>
      <realm name="corporate">
        <role name="peon"/>
      </realm>
    </user>
  </users>
</ns:securityInfo>
```

In order for the login step to succeed, an Artix client must supply one of the usernames and passwords that appear in this file. The realm and role data, which also appear, are used for authorization and access control.

For more details about the iSF file adapter, see [“Managing a File Security Domain” on page 344](#).

**Note:** The file adapter is a simple adapter that does *not* scale well for large enterprise applications. IONA supports the use of the file adapter in a production environment, but the number of users is limited to 200.

### Server domain configuration and access control

On the server side, authentication and authorization must be enabled by the appropriate settings in the server’s configuration file, `server.xml`.

[Example 7](#) explains the security layer settings that appear in the `server.xml` file.

#### Example 7: Security Layer Settings from the `server.xml` File

```
<?xml version="1.0" encoding="UTF-8"?>
<beans xmlns="http://www.springframework.org/schema/beans"
  xmlns:xsi="http://www.w3.org/2001/XMLSchema-instance"

  xmlns:http="http://cxf.apache.org/transports/http/configuration"
  xmlns:httpj="http://cxf.apache.org/transports/http-jetty/configuration"
  xmlns:jaxws="http://cxf.apache.org/jaxws"
  xmlns:sec="http://cxf.apache.org/configuration/security"
  xmlns:security="http://cxf.iona.com/security/rt/configuration"
  ... >
  ...
  1 <jaxws:endpoint
    name="{http://apache.org/hello_world_soap_http}SoapPort"
    createdFromAPI="true">
      2 <jaxws:features>
          3 <security:WSSUsernameTokenAuthServerConfig
              4 aclURL="file:etc/acl.xml"
              5 aclServerName="artix.java.security.sample"
              authorizationRealm="corporate"
            />
          </jaxws:features>
        </jaxws:endpoint>
        ...
</beans>
```

The preceding server configuration settings can be explained as follows:

1. The configuration settings in the `jaxws:endpoint` element are applied to the endpoint identified by the QName, `{http://apache.org/hello_world_soap_http}SoapPort`.
2. The `security:WSSUsernameTokenAuthServerConfig` element configures the server to perform authentication and authorization based on the received WSS UsernameToken. Internally, this element causes the JAX-WS Bus to insert a handler that intercepts incoming requests.
3. The `aclURL` attribute specifies the location of an access control list file, `acl.xml`. The access control list determines which operations the incoming request is allowed to invoke (see [“Access control list/action-role mapping file”](#)).
4. The `aclServerName` attribute specifies which of the `action-role-mapping` elements in the action role mapping file should apply to the incoming requests. The value of the `aclServerName` attribute must match the contents of the `server-name` element in one of the `action-role-mapping` elements (see [“Access control list/action-role mapping file”](#)).
5. The Artix authorization realm determines which of the user’s roles will be considered during an access control decision. Artix authorization realms provide a way of grouping user roles together. The `IONAGlobalRealm` (the default) includes all user roles.

### Access control list/action-role mapping file

**Example 8** shows the contents of the action-role mapping file, `acl.xml`, for the HelloWorld demonstration.

#### **Example 8:** *Action-Role Mapping file for the HelloWorld Demonstration*

```
<?xml version="1.0" encoding="utf-8"?>
<secure-system
  xmlns="http://schemas.iona.com/security/acl"
  xmlns:xsi="http://www.w3.org/2001/XMLSchema-instance"
  xsi:schemaLocation="http://schemas.iona.com/security/acl
  acl.xsd" >
  <action-role-mapping>
    <server-name>artix.java.security.sample</server-name>
    <interface>
```

**Example 8:** *Action-Role Mapping file for the HelloWorld Demonstration*

```
<name>{http://apache.org/hello_world_soap_http}Greeter</name>
  <action-role>
    <action-name>sayHi</action-name>
    <role-name>guest</role-name>
  </action-role>
  <action-role>
    <action-name>greetMe</action-name>
    <role-name>president</role-name>
  </action-role>
</interface>
</action-role-mapping>
</secure-system>
```

For a detailed discussion of how to define access control using action-role mapping files, see [“Managing Users, Roles and Domains”](#) on page 335.

---

# Secure SOAP Demonstration—C++ Runtime

---

## Overview

This section provides a brief overview of how the Artix security framework provides security for SOAP bindings between an Artix client and an Artix server. The Artix security framework is a comprehensive security framework that supports authentication and authorization using data stored in a central security service (the Artix security service). This discussion is illustrated by reference to the secure HelloWorld demonstration.

---

## In this section

This section contains the following subsections:

<a href="#">Secure Hello World Example</a>	<a href="#">page 48</a>
<a href="#">HTTPS Connection</a>	<a href="#">page 51</a>
<a href="#">IIOP/TLS Connection</a>	<a href="#">page 55</a>
<a href="#">Security Layer</a>	<a href="#">page 62</a>

# Secure Hello World Example

## Overview

This section provides an overview of the secure HelloWorld demonstration, which introduces several features of the Artix Security Framework. In particular, this demonstration shows you how to configure a typical Artix client and server that communicate with each other using a SOAP binding over a HTTPS transport. Figure 5 shows all the parts of the secure HelloWorld system, including the various configuration files.

**Figure 5:** Overview of the Secure HelloWorld Example

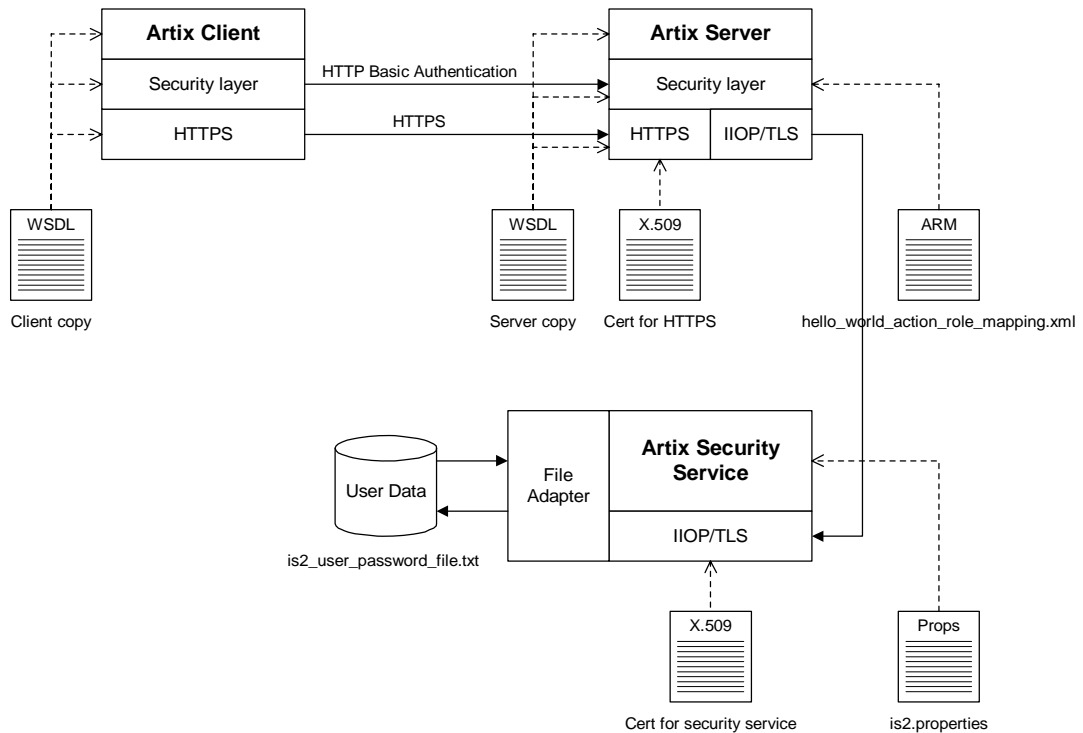



---

<b>Location</b>	The secure HelloWorld demonstration is located in the following directory: <code>ArtixInstallDir/cxx_java/samples/security/full_security</code>
<b>Main elements of the example</b>	The main elements of the secure HelloWorld example shown in <a href="#">Figure 5</a> are, as follows: <ul style="list-style-type: none"><li>• <a href="#">HelloWorld client</a>.</li><li>• <a href="#">HelloWorld server</a>.</li><li>• <a href="#">Artix security service</a>.</li></ul>
<b>HelloWorld client</b>	The HelloWorld client communicates with the HelloWorld server using SOAP over HTTPS, thus providing confidentiality for transmitted data. In addition, the HelloWorld client is configured to use HTTP BASIC authentication to transmit a username and a password to the server.
<b>HelloWorld server</b>	The HelloWorld server employs two different kinds of secure transport, depending on which part of the system it is talking to: <ul style="list-style-type: none"><li>• HTTPS—to receive SOAP invocations securely from the HelloWorld client.</li><li>• IIOP/TLS—to communicate securely with the Artix security service, which contains the central store of user data.</li></ul>
<b>Artix security service</b>	<p>The Artix security service manages a central repository of security-related user data. The Artix security service can be accessed remotely by Artix servers and offers the service of authenticating users and retrieving authorization data.</p> <p>The Artix security service supports a number of adapters that can be used to integrate with third-party security products (for example, an LDAP adapter is available). This example uses the <i>iSF file adapter</i>, which is a simple adapter provided for demonstration purposes.</p> <p><b>Note:</b> The file adapter is a simple adapter that does <i>not</i> scale well for large enterprise applications. IONA supports the use of the file adapter in a production environment, but the number of users is limited to 200.</p>

---

## Security layers

To facilitate the discussion of the HelloWorld security infrastructure, it is helpful to analyze the security features into the following layers:

- [HTTPS layer](#).
- [IIOP/TLS layer](#).
- [Security layer](#).

---

## HTTPS layer

The HTTPS layer provides a secure transport layer for SOAP bindings. In Artix, the HTTPS transport is configured by editing the Artix configuration file (for example, `full_security.cfg`). Some of the HTTPS settings can optionally be set in the WSDL contract instead (both the client copy and the server copy).

For more details, see [“HTTPS Connection” on page 51](#).

---

## IIOP/TLS layer

The IIOP/TLS layer consists of the OMG’s Internet Inter-ORB Protocol (IIOP) combined with the SSL/TLS protocol. In Artix, the IIOP/TLS is configured by editing the Artix configuration file.

For more details, see [“IIOP/TLS Connection” on page 55](#).

---

## Security layer

The security layer provides support for a simple username/password authentication mechanism, a principal authentication mechanism and support for authorization. A security administrator can edit an *action-role mapping file* to restrict user access to particular WSDL port types and operations.

For more details, see [“Security Layer” on page 62](#).

## HTTPS Connection

### Overview

Figure 6 shows an overview of the HelloWorld example, focusing on the elements relevant to the HTTPS connection. HTTPS is used on the SOAP binding between the Artix client and the Artix server.

**Figure 6:** A HTTPS Connection in the HelloWorld Example

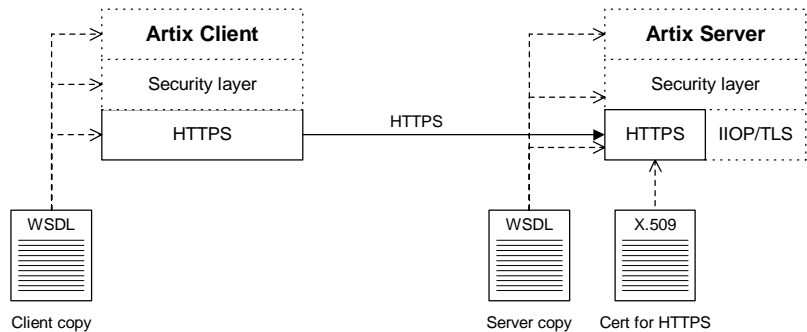

### Baltimore toolkit

HTTPS transport security is provided by the Baltimore toolkit, which is a commercial implementation of the SSL/TLS protocol.

The Baltimore toolkit supports a wide range of cipher suites—see [“Supported Cipher Suites” on page 258](#).

### Mutual authentication

The HelloWorld example is configured to use *mutual authentication* on the client-to-server HTTPS connection. That is, during the TLS handshake, the server authenticates itself to the client (using an X.509 certificate) and the client authenticates itself to the server. Hence, both the client and the server require their own X.509 certificates.

**Note:** You can also configure your application to use *target-only authentication*, where the client does not require an own X.509 certificate. See [“Requiring Authentication” on page 196](#) for details.

## Enabling HTTPS

To enable HTTPS, you must ensure that the URL identifying the service endpoint in the WSDL contract has the `https:` prefix. For example, the HelloWorld service specifies a SOAP over HTTPS endpoint in the `hello_world.wsdl` file as follows:

```
<wsdl:definitions name="HelloWorld"
  targetNamespace="http://www.iona.com/hello_world_soap_http"
  xmlns:soap="http://schemas.xmlsoap.org/wsdl/soap/"
  xmlns:wsdl="http://schemas.xmlsoap.org/wsdl/" ... >
  ...
  <wsdl:service name="SOAPService">
    <wsdl:port binding="tns:Greeter_SOAPBinding"
      name="SoapPort">
      <soap:address location="https://localhost:9000"/>
    </wsdl:port>
  </wsdl:service>
</wsdl:definitions>
```

## Client HTTPS configuration

[Example 9](#) shows how to configure the client side of an HTTPS connection, in the case of mutual authentication.

### Example 9: Extract from the Secure Client HTTPS Configuration

```
# Artix Configuration File
include "../../../../../etc/domains/artix.cfg";

secure_artix
{
  full_security
  {
    ...
    client
    {
      orb_plugins = ["local_log_stream"];

1         plugins:at_http:client:use_secure_sockets="true";
2         plugins:at_http:client:trusted_root_certificates =
"C:\Programs\artix_5.0/cxx_java/samples/security/certificates
/openssl/x509/ca/cacert.pem";
3         plugins:at_http:client:client_certificate =
"C:\Programs\artix_5.0/cxx_java/samples/security/certificates
/openssl/x509/certs/testaspen.p12";
4         plugins:at_http:client:client_private_key_password =
"testaspen";
```

**Example 9:** *Extract from the Secure Client HTTPS Configuration*

```

    ...
    };
};
};

```

The preceding extract from `full_security.cfg` can be explained as follows:

1. The `use_secure_sockets` configuration variable is set to `true` to enable HTTPS security.

**Note:** This is not the only approach you can use to configure HTTPS security. The alternative approach is to configure HTTPS security policies directly, which gives you more control over the TLS connection properties. For example, see [“Securing HTTP Communications with TLS—C++ Runtime” on page 103](#).

2. A HTTPS application needs a list of trusted CA certificates, which it uses to determine whether or not to trust certificates received from other HTTPS applications. See [“Specifying Trusted CA Certificates” on page 206](#) for more details.
3. Because this example uses mutual authentication, you are required to provide the client with its own X.509 certificate, by setting the `plugins:at_http:client:client_certificate` configuration variable. The certificate must be in PKCS#12 format. See [“Managing Certificates” on page 171](#) for more details about X.509 certificates.
4. A password must be provided for the preceding certificate (in PKCS#12 format, the certificate and its private key are encrypted).

**Server HTTPS configuration**

[Example 10](#) shows how to configure the server side of an HTTPS connection, in the case of target-only authentication.

**Example 10:** *Extract from the Secure Server HTTPS Configuration*

```

# Artix Configuration File
include "../../../../../etc/domains/artix.cfg";

secure_artix
{
    full_security

```

**Example 10:** *Extract from the Secure Server HTTPS Configuration*

```

{
    ...
    server
    {
        orb_plugins = ["local_log_stream", "iiop_profile",
"giop", "iiop_tls", "artix_security"];
        binding:artix:server_request_interceptor_list=
"security";
        ...
1         plugins:at_http:server:use_secure_sockets="true";
2         plugins:at_http:server:trusted_root_certificates =
"C:\Programs\artix_5.0\cxx_java\samples\security\certificates
/openssl/x509/ca/cacert.pem";
3         plugins:at_http:server:server_certificate =
"C:\Programs\artix_5.0\cxx_java\samples\security\certificates
/openssl/x509/certs/testaspen.p12";
4         plugins:at_http:server:server_private_key_password =
"testaspen";
        ...
    };
};
};

```

The preceding extract from `full_security.cfg` can be explained as follows:

1. The `use_secure_sockets` configuration variable is set to `true` to enable HTTPS security.
2. The server needs a list of trusted CA certificates, which it uses to determine whether or not to trust certificates received from the client over HTTPS. See [“Specifying Trusted CA Certificates” on page 206](#) for more details.
3. You must provide the server with its own X.509 certificate, by setting the `plugins:at_http:server:server_certificate` configuration variable. The certificate must be in PKCS#12 format. See [“Managing Certificates” on page 171](#) for more details about X.509 certificates.
4. A password must be provided for the preceding certificate (in PKCS#12 format, the certificate and its private key are encrypted).

## IIOPTLS Connection

### Overview

Figure 7 shows an overview of the HelloWorld example, focusing on the elements relevant to the IIOPTLS connection between the Artix server and the Artix security service. In general, the Artix security service is usually accessed through the IIOPTLS transport.

**Figure 7:** *An IIOPTLS Connection in the HelloWorld Example*

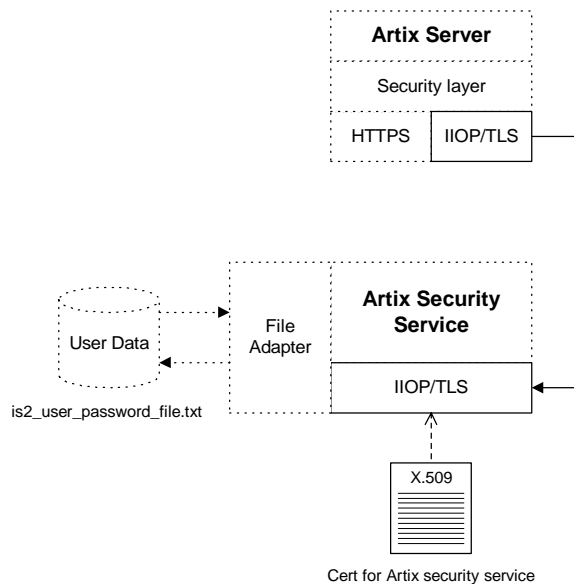

### Baltimore toolkit

IIOPTLS transport security is provided by the Baltimore toolkit, which is a commercial implementation of the SSL/TLS protocol.

The Baltimore toolkit supports a wide range of cipher suites—see [“Supported Cipher Suites” on page 258](#).

**Mutual authentication**

The HelloWorld example is configured to use *mutual authentication* on the client-to-server IIOP/TLS connection. That is, during the TLS handshake, the server authenticates itself to the client (using an X.509 certificate) and the client authenticates itself to the server. Hence, both the client and the server require their own X.509 certificates.

**Note:** You can also configure your application to use *target-only authentication*, where the client does not require an own X.509 certificate. See [“Requiring Authentication” on page 196](#) for details.

**Artix server IIOP/TLS configuration**

The Artix server’s IIOP/TLS transport is configured by the settings in the `ArtixInstallDir/cxx_java/samples/security/full_security/etc/full_security.cfg` file. [Example 11](#) shows an extract from the `full_security.cfg` file, highlighting some of the settings that are important for the HelloWorld Artix server.

**Example 11:** *Extract from the Artix Server IIOP/TLS Configuration*

```
# Artix Configuration File
include "../../../../../etc/domains/artix.cfg";

secure_artix
{
    full_security
    {
1      initial_references:IT_SecurityService:reference =
        "corbaloc:it_iiops:1.2@localhost:55020/IT_SecurityService";

        server
        {
            binding:artix:server_request_interceptor_list=
2      "security";
            orb_plugins = ["local_log_stream", "iiop_profile",
3      "giop", "iiop_tls", "artix_security"];
            ...
            # secure iiop_tls server -> security service
            principal_sponsor:iiop_tls:use_principal_sponsor =
            "true";
            principal_sponsor:iiop_tls:auth_method_id =
            "pkcs12_file";
```



**Example 11:** *Extract from the Artix Server IIOp/TLS Configuration*

```

principal_sponsor:iiop_tls:auth_method_data =
["filename=C:\Programs\artix_5.0\cxx_java\samples\security\ce
rtificates\tls\x509\certs\services\administrator.p12",
"password_file=C:\Programs\artix_5.0\cxx_java\samples\securit
y\certificates\tls\x509\certs\services\administrator.pwf"];

4 policies:iiop_tls:trusted_ca_list_policy =
"C:\Programs\artix_5.0\cxx_java\samples\security\certificates
\tls\x509\trusted_ca_lists\ca_list1.pem";
...
};
};
};
};

```

The preceding extract from the Artix configuration file can be explained as follows:

1. The `IT_SecurityService` initial reference gives the location of the Artix security service. The Artix server uses this `corbaloc` URL to open an IIOp/TLS connection to the Artix security service. In this example, the Artix security service is presumed to be running on `localhost` and listening on the 55020 IP port.
2. The `orb_plugins` list specifies which Artix plug-ins to load as the server starts up. The `iiop_tls` plug-in is included in the list (thus enabling IIOp/TLS connections), whereas the `iiop` plug-in is excluded (thus disabling plain, insecure IIOp connections).
3. The `principal_sponsor` settings are used to attach a certificate to the Artix server. The server uses this certificate to identify itself to the security service during the IIOp/TLS handshake.

**Note:** In this example, the certificate password is specified in a password file, `administrator.pwf` (in a plain text format). For alternative ways of specifying the certificate password, see [“Deploying Own Certificate for IIOp/TLS” on page 223](#).

4. The `policies:iiop_tls:trusted_ca_list_policy` variable specifies a file containing a concatenated list of CA certificates. These CA certificates are used to check the acceptability of any certificates

received by the Artix server over the IIOP/TLS transport. If a received certificate has not been digitally signed by one of the CA certificates in the list, it will be rejected by the Artix server.

For more details, see [“Specifying Trusted CA Certificates” on page 206](#).

## Artix security service IIOP/TLS configuration

**Example 12** shows an extract from the `full_security.cfg` file, highlighting the IIOP/TLS settings that are important for the Artix security service.

### Example 12: Extract from the Security Service IIOP/TLS Configuration

```
# full_security.cfg File
secure_artix
{
    full_security
    {
        initial_references:IT_SecurityService:reference =
"corbaloc:it_iiops:1.2@localhost:55020/IT_SecurityService";
        ...
        security_service
        {
            # IIOP/TLS Settings
            ...
1         policies:trusted_ca_list_policy =
"C:\Programs\artix_5.0/cxx_java/samples/security/certificates
/tls/x509/trusted_ca_lists/ca_list1.pem";

2         principal_sponsor:use_principal_sponsor = "true";
        principal_sponsor:auth_method_id = "pkcs12_file";
        principal_sponsor:auth_method_data =
["filename=C:\Programs\artix_5.0/cxx_java/samples/security/ce
rtificates/tls/x509/certs/services/administrator.p12",
"password_file=C:\Programs\artix_5.0/cxx_java/samples/securit
y/certificates/tls/x509/certs/services/administrator.pwf"];
        ...
3         policies:target_secure_invocation_policy:requires =
["Confidentiality", "Integrity", "DetectReplay",
"DetectMisordering"];
        policies:target_secure_invocation_policy:supports =
["Confidentiality", "EstablishTrustInTarget",
"EstablishTrustInClient", "DetectMisordering",
"DetectReplay", "Integrity"];
    }
}
```

**Example 12:** *Extract from the Security Service IOP/TLS Configuration*

```

4     policies:client_secure_invocation_policy:requires =
      ["Confidentiality", "Integrity", "DetectReplay",
       "DetectMisordering"];
      policies:client_secure_invocation_policy:supports =
      ["Confidentiality", "EstablishTrustInTarget",
       "EstablishTrustInClient", "DetectMisordering",
       "DetectReplay", "Integrity"];

5     orb_plugins = ["local_log_stream", "iiop_profile",
                   "giop", "iiop_tls"];
      ...
6     plugins:security:iiop_tls:addr_list =
      ["localhost:55020"];
      ...
7 policies:security_server:client_certificate_constraints=["CN=Orb
   ix2000 IONA Services (demo cert)"];
8 policies:external_token_issuer:client_certificate_constraints= []
   ;
   };
   ...
   };
   ...
};

```

The preceding extract from the Artix configuration file can be explained as follows:

1. The `policies:trusted_ca_list_policy` variable specifies a file containing a concatenated list of CA certificates. These CA certificates are used to check the acceptability of any certificates received by the Artix security service over the IOP/TLS transport. If a received certificate has not been digitally signed by one of the CA certificates in the list, it will be rejected by the Artix security service.
2. The `principal_sponsor` settings are used to attach an X.509 certificate to the Artix security service. The certificate is used to identify the Artix security service to its peers during an IOP/TLS handshake. In this example, the Artix security service's certificate is stored in a PKCS#12 file, `administrator.p12`, and the certificate's private key password is stored in another file, `administrator.pwf`.

For more details about configuring the IIOp/TLS principal sponsor, see [“principal\\_sponsor” on page 680](#) and [“Deploying Own Certificate for IIOp/TLS” on page 223](#).

3. The target secure invocation policies specify what sort of secure IIOp/TLS connections the Artix security service can accept when it acts in a server role. For more details about the target secure invocation policy, see [“Setting Association Options” on page 244](#).

**Note:** Although not specified explicitly here in the target secure invocation policies, the security service *always* requires clients to present an X.509 certificate (equivalent to requiring `EstablishTrustInClient`).

4. The client secure invocation policies specify what sort of secure IIOp/TLS connections the Artix security service can open when it acts in a client role.
5. The `orb_plugins` list specifies which plug-ins should be loaded into the Artix security service. Of particular relevance is the fact that the `iiop_tls` plug-in is included in the list (thus enabling IIOp/TLS connections), whereas the `iiop` plug-in is excluded (thus disabling plain IIOp connections).
6. If you want to relocate the Artix security service, you must modify the `plugins:security:iiop_tls:addr_list` setting to specify the host where the server is running and the IP port on which the server listens for secure IIOp/TLS connections. The address entry shown here is of the form `Host:Port`.

**Note:** Normally, only one address is required. Multiple entries can be added to the address list in order to support failover and clustering. See [“Clustering and Federation” on page 313](#) for details.

7. An application can open a connection to the Artix security service only if it presents an X.509 certificate that satisfies the certificate constraints specified by this setting. For a detailed explanation of this setting, see [“Setting client certificate constraints” on page 274](#).

8. Disable the external token issuer feature by setting the token issuer certificate constraints to be an empty list (as shown here). This feature would be enabled only in the context of an integration with Artix mainframe.

# Security Layer

## Overview

Figure 8 shows an overview of the HelloWorld example, focusing on the elements relevant to the security layer. The security layer, in general, takes care of those aspects of security that arise *after* the initial SSL/TLS handshake has occurred and the secure connection has been set up.

**Figure 8:** *The Security Layer in the HelloWorld Example*

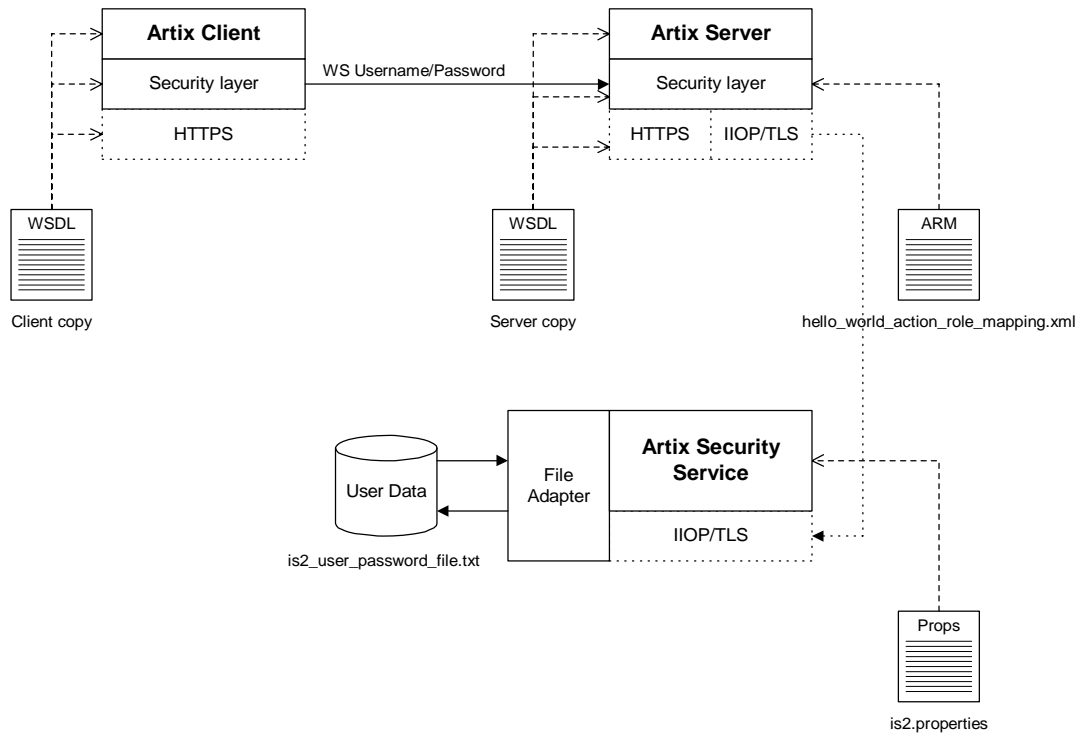

The security layer normally uses a simple username/password combination for authentication, because clients do not always have a certificate with which to identify themselves. The username and password are sent along with every operation, enabling the Artix server to check every invocation and make fine-grained access decisions.

## WS username/password login

The mechanism that the Artix client uses to transmit a username and password over the SOAP binding is the *WS username/password* credential. This mechanism is defined by the WS-Security standard and it involves transmitting a username token and a password token embedded in a SOAP header. In this example, the username and password tokens are protected from eavesdropping, because they are transmitted through an encrypted HTTPS connection.

The following extract from the Artix configuration file shows how to use the WSSE principal sponsor configuration variables to set the username and password tokens for the Artix SOAP client.

```
# Artix Configuration File
secure_artix {
    full_security {
        client {
            ...
            # WSSE principle sponsor mechanism
            principal_sponsor:wsse:use_principal_sponsor =
"true";
            principal_sponsor:wsse:auth_method_id =
"USERNAME_PASSWORD";
            principal_sponsor:wsse:auth_method_data =
["username=user_test", "password=user_password"];
        };
    };
};
```

In this example, the password is supplied directly in the Artix configuration file. For alternative ways of specifying the password, see [“principal\\_sponsor:wsse” on page 693](#).

**Authentication through the iSF file adapter**

On the server side, the Artix server delegates authentication to the Artix security service, which acts as a central repository for user data. The Artix security service is configured by the `is2.properties` file, whose location is specified in the `full_security.cfg` file as follows:

```
# full_security.cfg File
secure_artix {
  ...
  full_security {
    ...
    security_service {
      plugins:java_server:system_properties =
["org.omg.CORBA.ORBClass=com.iona.corba.art.artimpl.ORBImpl",
"org.omg.CORBA.ORBSingletonClass=com.iona.corba.art.artimpl.ORBSingleton",
"is2.properties=C:\Programs\artix_5.0\cxx_java\samples\security/full_security/etc/is2.properties.FILE",
"java.endorsed.dirs=C:\artix_30\artix\3.0\lib\endorsed"];
      ...
    };
    ...
  };
  ...
};
```

In this example, the `is2.properties` file specifies that the Artix security service should use a file adapter. The file adapter is configured as follows:

```
# is2.properties File
...
#####
##
## File Adapter Properties
##
#####
com.iona.isp.adapter.file.class=com.iona.security.is2adapter.file.FileAuthAdapter
com.iona.isp.adapter.file.params=filename
com.iona.isp.adapter.file.param.filename=is2_user_password_file.txt
```



The `com.iona.isp.adapter.file.param.filename` property is used to specify the location of a file, `is2_user_password_file.txt`, which contains the user data for the iSF file adapter. [Example 13](#) shows the contents of the user data file for the secure HelloWorld demonstration.

**Example 13:** *User Data from the `is2_user_password_file.txt` File*

```
<?xml version="1.0" encoding="utf-8" ?>
<ns:securityInfo xmlns:ns="urn:www-xmlbus-com:simple-security">
  <users>
    <users>
      <user name="user_test" password="user_password">
        <realm name="IONAGlobalRealm">
          <role name="IONAUserRole"/>
          <role name="IONASupplierRole"/>
        </realm>
      </user>
    </users>
  </users>
</ns:securityInfo>
```

In order for the login step to succeed, an Artix client must supply one of the usernames and passwords that appear in this file. The realm and role data, which also appear, are used for authorization and access control.

For more details about the iSF file adapter, see [“Managing a File Security Domain” on page 344](#).

**Note:** The file adapter is a simple adapter that does *not* scale well for large enterprise applications. IONA supports the use of the file adapter in a production environment, but the number of users is limited to 200.

## Server domain configuration and access control

On the server side, authentication and authorization must be enabled by the appropriate settings in the `full_security.cfg` file. [Example 14](#) explains the security layer settings that appear in the `full_security.cfg` file.

**Example 14:** *Security Layer Settings from the `full_security.cfg` File*

```
# Artix Configuration File
include "../../../../../etc/domains/artix.cfg";

secure_artix
{
```

**Example 14:** Security Layer Settings from the `full_security.cfg` File

```

full_security
{
  server
  {
    # IIOP/TLS Settings
    ...

    # Security Layer Settings
1   binding:artix:server_request_interceptor_list=
   "security";
2   orb_plugins = ["xmlfile_log_stream", "iiop_profile",
   "giop", "iiop_tls", "soap", "at_http", "artix_security",
   "https"];

3   policies:asp:enable_authorization = "true";
4   plugins:is2_authorization:action_role_mapping =
   "file://C:\Programs\artix_5.0\cxx_java\samples\security\full_
   security\etc\helloworld_action_role_mapping.xml";
5   plugins:asp:authorization_realm = "IONAGlobalRealm";
6   plugins:asp:security_level = "REQUEST_LEVEL";
   plugins:asp:authentication_cache_size = "5";
   plugins:asp:authentication_cache_timeout = "10";
   };
};
};

```

The security layer settings from the `full_security.cfg` file can be explained as follows:

1. The Artix server request interceptor list must include the `security` interceptor, which provides part of the functionality for the Artix security layer.
2. The server's `orb_plugins` list must include the `artix_security` plug-in.
3. The `policies:asp:enable_authorization` variable is set to `true` to enable authorization.
4. This setting specifies the location of an *action-role mapping file* that provides fine-grained access control to operations and port types.

5. The Artix authorization realm determines which of the user's roles will be considered during an access control decision. Artix authorization realms provide a way of grouping user roles together. The `IONAGlobalRealm` (the default) includes all user roles.
6. The `plugins:asp:security_level` variable specifies which client credentials are used for the purposes of authentication and authorization on the server side (in this case, the `REQUEST_LEVEL` value indicates that the username/password credentials are sent in the SOAP header).

[Example 15](#) shows the contents of the action-role mapping file for the HelloWorld demonstration.

**Example 15:** *Action-Role Mapping file for the HelloWorld Demonstration*

```
<?xml version="1.0" encoding="UTF-8"?>
<!DOCTYPE secure-system SYSTEM "actionrolemapping.dtd">
<secure-system>
  <action-role-mapping>
    <server-name>secure_artix.full_security.server</server-name>

    <interface>
      <name>http://www.iona.com/full_security:Greeter</name>
      <action-role>
        <action-name>sayHi</action-name>
        <role-name>IONAUserRole</role-name>
      </action-role>
      <action-role>
        <action-name>greetMe</action-name>
        <role-name>IONAUserRole</role-name>
      </action-role>
    </interface>

  </action-role-mapping>
</secure-system>
```

For a detailed discussion of how to define access control using action-role mapping files, see [“Managing Users, Roles and Domains” on page 335](#).

# Secure Container Demonstration

## Location of demonstration

The secure container demonstration is located in the following directory:

```
ArtixInstallDir/cxx_java/samples/advanced/container/secure_container
```

## Scenario description

The secure container demonstration illustrates a scenario where some components are configured to be secure while others are insecure. The various components are configured as follows:

- *WSDL publishing service*—provides the main point of contact with the container (runs on the port specified by the container's `-port` option). This endpoint is insecure.
- *Container service*—provides administrative operations, which can be accessed using the `it_container_admin` utility. This endpoint is secured through HTTPS and the Artix security layer.
- *Other Artix services*—can be either secure or insecure, depending on the settings in the WSDL contract.

## Connecting to the container service

Figure 9 shows an overview of how the `it_container_admin` client establishes a secure connection to the `ContainerService` service.

**Figure 9:** *Connecting to a Secure Container Service*

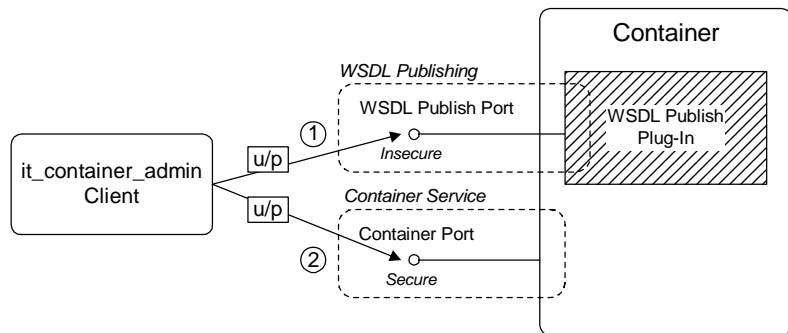

The connection from the `it_container_admin` client to the `ContainerService` service is established in two steps, as follows:

1. The `it_container_admin` client sends a message to the port supplied to the `-port` option, requesting the WSDL publishing service to send the WSDL contract for the `ContainerService` service.

**Note:** This initial connection is *insecure*, because the WSDL publishing service is configured to be insecure in this demonstration. The username and password sent by the `it_container_admin` client are therefore potentially vulnerable to eavesdropping in this scenario.

2. Using the endpoint details from the retrieved WSDL contract, the `it_container_admin` client establishes a secure connection to the `ContainerService` endpoint. With every operation invocation on the `ContainerService` service, the `it_container_admin` client sends WSS username and password credentials, `u/p`, to authenticate itself to the container.

---

## Configuring the secure container

In this scenario, the container service is configured to have the following security characteristics:

- The container service accepts only HTTPS connections.
- Clients of the container service can present X.509 certificates, but are not required to do so.
- Clients must present WSS username and password credentials.
- The received WSS username and password credentials are sent to the Artix security service to be authenticated.
- Depending on which configuration is used to run the container service, the Artix security plug-in might also limit what clients can do by applying role-based access control.

For most of the preceding security features, the container service is configured in a similar way to any other Artix server (for example, see the details of secure Artix server configuration in [“Secure SOAP Demonstration—C++ Runtime” on page 47](#)).

The following configuration setting, however, is specific to the secure container service:

```
plugins:at_http:server:use_secure_sockets:container = "true";
```

This boolean variable enables the HTTPS protocol for the container service alone. Because the effect of this variable is restricted to the container service, it is possible also to deploy other insecure services into the container.

When `plugins:at_http:server:use_secure_sockets:container` is `true`, HTTPS is enabled for the container service only (subject to the effective target secure invocation policy); when `false`, HTTPS is not specifically enabled (although other configuration settings might enable it). The default is `false`.

**Note:** This behavior contrasts with the behavior of the `plugins:at_http:server:use_secure_sockets` variable, which enables HTTPS for *all* services in the container (including the `ContainerService` service itself).

### Configuring the secure `it_container_admin` utility

In order to administer a secure container with the `it_container_admin` utility, it is necessary to define a custom configuration scope. The configuration scope enables the `it_container_admin` utility to invoke remote administration commands securely.

#### Example 16: Configuration for Connecting to Secure Container

```
# Artix Configuration File
secure_artix
{
  secure_container
  {
    client_authentication
    {
1      orb_plugins = ["xmlfile_log_stream", "https"];
2      policies:https:trusted_ca_list_policy =
"%{ROOT_TRUSTED_CA_LIST_POLICY_1}";
3
4      bus:security:enable_security = "true";

      principal_sponsor:use_principal_sponsor = "true";
      principal_sponsor:auth_method_id = "pkcs12_file";
      principal_sponsor:auth_method_data =
["filename=%{PRIVATE_CERT_1}",
"password_file=%{PRIVATE_CERT_PASSWORD_FILE_1}"];
    };
  };
};
```

**Example 16:** *Configuration for Connecting to Secure Container*

```
};
```

The preceding configuration can be explained as follows:

1. This line loads the `https` plug-in at start-up time. This is not strictly necessary, however, because Artix can load the `https` plug-in dynamically whenever it is needed.

**Note:** In particular, loading the `https` plug-in does not automatically enable HTTPS security. The `it_container_admin` client dynamically enables security for any service whose address URL starts with the `https:` prefix.

2. The client side of a HTTPS connection must always provide a list of trusted CA certificates. During the SSL/TLS handshake, the client checks that the server certificate has been signed by a trusted CA.
3. The `bus:security:enable_security` variable is set to `true`, to enable authentication using WSS username and password on the client side. In this case, because the username and password are not explicitly provided in configuration, the `it_container_admin` utility will prompt the user to enter the username and password from the command line in a secure mode (where keystrokes cannot be intercepted).
4. The `principal_sponsor` settings associate an X.509 certificate with the `it_container_admin` client. You only need to include these settings, if the container is configured to require client authentication.

To run the `it_container_admin` utility with the preceding configuration, enter a command of the following form:

```
it_container_admin -BUSname
    secure_artix.secure_container.client_authentication_config
    -port Port CommandOption
```

Where the `Port` option specifies the IP port where the container is listening for connections and the `CommandOption` specifies one of the container administration commands (see *Configuring and Deploying Artix Solutions* for details of `it_container_admin` commands).

When you run the `it_container_admin` command, you will be prompted as follows for the WSS username and password:

```
Please enter login : WSS_Username
Please enter password :
```

Instead of providing the WSS username and password at the command line, you can provide them directly in the configuration file using the following settings:

```
bus:security:user_name = "WSS_Username";
bus:security:user_password = "WSS_Password";
```

---

## Configuring deployed Artix services

Because the services in the container (including the `ContainerService` itself) all share the same Artix configuration, you must edit the endpoint settings in the WSDL contract, in order to tailor the security settings for individual services.

For example, for a SOAP over HTTP service, there are two main aspects of security that can be enabled:

- *HTTPS security*—requires incoming connections to use SSL/TLS.
- *Artix security layer*—enables authentication of credentials through the Artix security service. Optionally, this might also involve authorization using role-based access control.

You can selectively enable or disable these two security features by editing the service's WSDL contract as follows:



### Enable HTTPS security and Artix security layer

To enable both HTTPS security and the Artix security layer for the `WellWisherService` service in the secure container demonstration, use the following endpoint configuration:

```
<definitions ... >
...
<service name="WellWisherService">
  <port binding="tns:WellWisher_SOAPBinding"
        name="WellWisherPort">
    <soap:address
      location="https://localhost:9999/wellwisher"/>
    </port>
  </service>
</definitions>
```

Where the HTTPS protocol is enabled by putting the `https:` prefix in the SOAP URL and the Artix security layer is implicitly enabled (because the container configuration already enables Artix security).

### Enable HTTPS security only

To enable HTTPS only for the `WellWisherService` service, use the following endpoint configuration:

```
<definitions ... >
...
<service name="WellWisherService">
  <port binding="tns:WellWisher_SOAPBinding"
        name="WellWisherPort">
    <soap:address
      location="https://localhost:9999/wellwisher"/>
    <bus-security:security enableSecurity="false"/>
    </port>
  </service>
</definitions>
```

Where the Artix security layer is explicitly disabled (for this endpoint only) by setting the `enableSecurity` attribute to `false` in the `bus-security:security` element.

### Insecure service

To disable security completely for the `WellWisherService` service, use the following endpoint configuration:

```

<definitions ... >
  ...
  <service name="WellWisherService">
    <port binding="tns:WellWisher_SOAPBinding"
          name="WellWisherPort">
      <soap:address
        location="http://localhost:9999/wellwisher"/>
      <bus-security:security enableSecurity="false"/>
    </port>
  </service>
</definitions>

```

Where the insecure HTTP protocol is selected by putting the `http:` prefix in the SOAP URL and the Artix security layer is explicitly disabled for this endpoint. You must also ensure that `plugins:at_http:use_secure_sockets` is not set to `true` in the Artix configuration (this setting would force the port to use the HTTPS protocol).

### Securing the WSDL publishing service

It is possible to make the container completely secure by securing the WSDL publishing service (in addition to securing the container service).

Details of how to deploy the WSDL publishing service securely in a container are given in [“Deploying WSDL Publish in a Container” on page 423](#).

**Note:** Artix 4.0 has a limitation, which forces you to make *all* of the services in a container secure, if you make the WSDL publishing service secure.

---

# Debugging with the openssl Utility

---

## Overview

The OpenSSL toolkit is an open source implementation of SSL and TLS. OpenSSL provides a utility, `openssl`, which includes two powerful tools for debugging SSL/TLS client and server applications, as follows:

- `openssl s_client`—an SSL/TLS test client, which can be used to test secure Artix servers. The test client can connect to a secure port, while providing a detailed log of the steps performed during the SSL/TLS handshake.
- `openssl s_server`—an SSL/TLS test server, which can be used to test secure Artix clients. The test server can simulate a bare bones SSL/TLS server (handshake only). Additionally, by supplying the `-www` switch, the test server can also simulate a simple secure Web server.

---

## OpenSSL command-line utility

Artix versions 4.1 and later include the `openssl` command-line utility, which is a general-purpose SSL/TLS utility. See “[OpenSSL Utilities](#)” on [page 743](#) for more details.

---

## References

For complete details of the `openssl s_client` and the `openssl s_server` commands, see the following OpenSSL documentation pages:

- [http://www.openssl.org/docs/apps/s\\_client.html](http://www.openssl.org/docs/apps/s_client.html)
- [http://www.openssl.org/docs/apps/s\\_server.html](http://www.openssl.org/docs/apps/s_server.html)

---

## Debugging example

Consider the HelloWorld demonstration discussed in the previous section, [Secure SOAP Demonstration—C++ Runtime](#) [page 47](#). This demonstration consists of a client and a target server.

To demonstrate SSL debugging, you can use the `openssl` test client to connect directly to the target server.

**Debugging steps**

The following table shows the steps required to debug a secure server by connecting to that server using the `openssl` test client:

Step	Action
1	Convert the client certificate to PEM format.
2	Run the target server.
3	Obtain the target server's IP port.
4	Run the test client.

**Convert the client certificate to PEM format**

Certificates for Artix applications are deployed in PKCS#12 format, whereas the `openssl` test client requires the certificate to be in PEM format (a format that is proprietary to OpenSSL). It is, therefore, necessary to convert the client certificate to the PEM format.

For example, given the certificate `testaspen.p12` (located in the `ArtixInstallDir/cxx_java/samples/security/certificates/openssl/x509/certs` directory), you can convert the certificate to PEM format as follows.

1. Run the `openssl pkcs12` command, as follows:

```
openssl pkcs12 -in testaspen.p12 -out testaspen.pem
```

When you run this command you are prompted to enter, first of all, the pass phrase for the `testaspen.p12` file and then to enter a pass phrase for the newly created `testaspen.pem` file.

2. The `testaspen.pem` file generated in the previous step contains a CA certificate, an application certificate, and the application certificate's private key. Before you can use the `testaspen.pem` file with the `openssl` test client, however, you must remove the CA certificate from the file. That is, the file should contain only the application certificate and its private key.

For example, after deleting the CA certificate from the testaspen.pem file, the contents of the file should look something like the following:

```
Bag Attributes
  localKeyID: 6A F2 11 9B A4 69 16 3C 3B 08 32 87 A6 7D 7C 91
  C1 E1 FF 4A
  friendlyName: Administrator
subject=/C=US/ST=Massachusetts/O=ABigBank -- no warranty -- demo
purposes/OU=Administration/CN=Administrator/emailAddress=admini
strator@abigbank.com
issuer=/C=US/ST=Massachusetts/L=Boston/O=ABigBank -- no warranty
-- demo purposes/OU=Demonstration Section -- no warranty
--/CN=ABigBank Certificate
Authority/emailAddress=info@abigbank.com
-----BEGIN CERTIFICATE-----
MIEIeiTCCA/KgAwIBAgIBATANBgkqhkiG9w0BAQQFADCB5jELMAkGA1UEBhMCMVVMx
FjAUBgNVBAgTDDU1hc3NhY2h1c2V0dHMxDzANBgNVBACTBkJvc3RvbjJExMC8GA1UE
ChMoQUUpZ0JhbmsgLS0gY2F0ZSBBbDh1c2V0ZSBBbDh1c2V0ZSBBbDh1c2V0ZSBBbD
ALUECXMnRGVtb25zdHJhdG1vb25zdHJhdG1vb25zdHJhdG1vb25zdHJhdG1vb25zdH
JhdG1vb25zdHJhdG1vb25zdHJhdG1vb25zdHJhdG1vb25zdHJhdG1vb25zdHJhdG1vb
JQYDVQDEEx5BQm1nQmFuayBDZXJ0aWZpY2F0ZSBBbDh1c2V0ZSBBbDh1c2V0ZSBBbD
9w0BCQEWZWw1u2M9AYWJpZ2Z0aWZpY2F0ZSBBbDh1c2V0ZSBBbDh1c2V0ZSBBbD
NzEwNTE1NzEwNzEwNzEwNzEwNzEwNzEwNzEwNzEwNzEwNzEwNzEwNzEwNzEwNzEw
MTEwLWV0ZSBBbDh1c2V0ZSBBbDh1c2V0ZSBBbDh1c2V0ZSBBbDh1c2V0ZSBBbDh1
c2V0ZSBBbDh1c2V0ZSBBbDh1c2V0ZSBBbDh1c2V0ZSBBbDh1c2V0ZSBBbDh1c2V0
YXRvcjEpcCCEGCSGSIb3DQEJARYAaWRtYXN5bGVhbnR0aWZpY2F0ZSBBbDh1c2V0
gZ8wDQYJKoZIhvcNAQEBBQADgY0AMIGJAAoGBANK7503YBkkjCvgY0pOPxAU+M6Rt
0QzaQ8/YlciWlQ/oCT/17+3P/ZhHAJaT+QxmahQhdY5ePixGyaE7raut2MdjHOuO
wCKtZqlhuNa8jujSvsN5iTuupzp/mRQ/j4r0xr8gWI5dh5d/kF4+H5s8yrxNjrdg
tY7fdxP9Kt0x9sYPAgMBAAGjggF1MIIBCATAJBGNVHRMEAjAAMCwGCWGSAGG+EIB
DQQfFh1PcGVuU1NMIEdlbmVyYXR1ZCBDbDZ0aWZpY2F0ZSBBbDh1c2V0ZSBBbDh1c
9LPZPsaE9+a/FwbCz2LQxWkwggEVBGNVHSMEGgEMMIIBCIAUhJz9oNb6Yq8d1nbH
BPjtS7uI0WyhgeykekwgeYxCzAJBgNVBAYTALVTMRYWFAFDVQZSBBbDh1c2V0ZSBB
dXNldHRzMzEwNzEwNzEwNzEwNzEwNzEwNzEwNzEwNzEwNzEwNzEwNzEwNzEwNzEw
dXNldHRzMzEwNzEwNzEwNzEwNzEwNzEwNzEwNzEwNzEwNzEwNzEwNzEwNzEwNzEw
IHDhcNjhbNzEwNzEwNzEwNzEwNzEwNzEwNzEwNzEwNzEwNzEwNzEwNzEwNzEwNzEw
b24gU2VjdG1vb25zdHJhdG1vb25zdHJhdG1vb25zdHJhdG1vb25zdHJhdG1vb25zd
Q2VydG1maWw1u2M9AYWJpZ2Z0aWZpY2F0ZSBBbDh1c2V0ZSBBbDh1c2V0ZSBBbD
YW5rLmNvb3R5IBADANBgkqhkiG9w0BAQQFAAOBgQCS5R5RiDsK3ZChIvPHQRpQj5BA
J5DYTAmgZac7pkxy8rQzYvG5FjHL7beuzT3jdM2fvQJ8M7t8EMkHKPqeguArny+x
3VNGwWv1kr5jQTDeOd7d9Ilo2fknQA14j/wPFEDUwdz4n9TThjE7lpj6zG27EivF
cm/h2L/DpwgZK0TQ9Q==
-----END CERTIFICATE-----
```

```

Bag Attributes
  localKeyID: 6A F2 11 9B A4 69 16 3C 3B 08 32 87 A6 7D 7C 91
  C1 E1 FF 4A
  friendlyName: Administrator
Key Attributes: <No Attributes>
-----BEGIN RSA PRIVATE KEY-----
Proc-Type: 4, ENCRYPTED
DEK-Info: DES-EDE3-CBC,AD8F864A0E97FB4E

e3cexhY+kAujb6c0s9skerP2qZsauce33yyp4cdZiAkAilcmfA/mLv2pfgao8gfu9
yroNvYyDADEZzagEyzF/4FGUlnScZjAiy9Imi9mA/1SHD5g1HH/wl2bgXclBqtC3
GrfiHzGmbWyzDUj0PHjw/EkbyxQBJSce4fPuCGVH7frcgCPElq2EqRKBHca3vkHr
6hrwuWS18TXn8DtcCFftougouHXwKeGjJxE5PYfKak18BOWKgiZqtj1DHY6G2oERl
ZgNtAB+XF9vrA5XZHnsU6RBeXmVsrU1OGzdVrCnoj d6d8Be7Q7KBSHDV9XzZ1PKp
7DYVn5DyFSEQ7kYs9dsaZ5Id5iNkMJiscPp7AL2SJAwpY1UfEN5gFnIYiwXP1ckF
STTiQ+BG8UPPm6G3KGgRZMZ0Ih7DySZufbe24NIrN74kXV9Vf/RpxzNiMz/PbLdG
6wiyp47We/4OqxLv8YIjGGEdYyaB/Y7XEyE9ZL74Dc3CcuSvtA2fC8hU3cXjKBu7
YsVz/Dq8G0w223owpZ0Qz2KUL9CLq/hmYLOJt1yLVoaGZuJ1CWXdgX0dComDOR8K
aIaUagy/Gz2zys20N5WRK+s+HzqoB0vmeOy4Z1Ss71HfGAUemiRTAI8DXizgyHYK
5m6iSSB961xOM7YI58JYOGNLMXzLmCUAyCQhklWGFEN4cZBrkh5o6r+U4FchwF
dvDoBu39Xie5gHFrJU86qhzxi202h0sO2vexvujSGyNy009PJGKEAhJGfOG+a2Qq
VBwuUZqo0zIJ6gUrMV1LOAWwL7zFxyKaF5lijF1C9KxtEKm0393zag==
-----END RSA PRIVATE KEY-----

```

### Run the target server

Run the target server, as described in the `README.txt` file in the `demosecurity/full_security` directory.

### Obtain the target server's IP port

In this demonstration, the server's IP port is specified explicitly in the WSDL contract, `demosecurity/full_security/etc/hello_world.wsdl`. For example, in this contract the `SOAPService` service is configured as follows:

```

<wsdl:definitions name="HelloWorld"
  targetNamespace="http://www.iona.com/full_security"
  ...
>
  ...
  <wsdl:service name="SOAPService">
    <wsdl:port binding="tns:Greeter_SOAPBinding"
      name="SoapPort">
      <soap:address location="https://localhost:9000"/>
    </wsdl:port>
  </wsdl:service>
</wsdl:definitions>

```

In this example, the target server's IP port is 9000.

## Run the test client

To run the `openssl s_client` test client, open a command prompt, change directory to the directory containing the `testaspen.pem` file, and enter the following command:

```
openssl s_client -connect localhost:9000 -ssl3 -cert
testaspen.pem
```

When you enter the command, you are prompted to enter the pass phrase for the `testaspen.pem` file.

The `openssl s_client` command switches can be explained as follows:

`-connect host:port`

Open a secure connection to the specified *host* and *port*.

`-ssl3`

This option configures the client to initiate the handshake using SSL v3 (the default is SSL v2). To see which SSL version (or versions) the target server is configured to use, check the value of the `policies:mechanism_policy:protocol_version` variable in the Artix configuration file. Artix servers can also be configured to use TLS v1, for which the corresponding `openssl` command switch is `-tls1`.

`-cert testaspen.pem`

Specifies `testaspen.pem` as the test client's own certificate. The PEM file should contain only the application certificate and the application certificate's private key. The PEM file should *not* contain a complete certificate chain.

If your server is not configured to require a client certificate, you can omit the `-cert` switch.

### Other command switches

The `openssl s_client` command supports numerous other command switches, details of which can be found on the OpenSSL document pages. Two of the more interesting switches are `-state` and `-debug`, which log extra details to the command console during the handshake.





# Introduction to the Artix Security Framework

*This chapter describes the overall architecture of the Artix Security Framework.*

**In this chapter**

---

This chapter discusses the following topics:

<a href="#">Artix Security Architecture</a>	page 82
<a href="#">Caching of Credentials—C++ Runtime</a>	page 89

---

# Artix Security Architecture

## Overview

---

The Artix security architecture embraces a variety of protocols and security technologies. This section provides a brief overview of the security features supported by the different kinds of Artix bindings.

---

## In this section

This section contains the following subsections:

<a href="#">Types of Security Credential</a>	<a href="#">page 83</a>
<a href="#">Protocol Layers</a>	<a href="#">page 85</a>
<a href="#">Security Layer</a>	<a href="#">page 87</a>
<a href="#">Using Multiple Bindings</a>	<a href="#">page 88</a>

---

## Types of Security Credential

---

### Overview

The following types of security credentials are supported by the Artix security framework:

- [WSS username token](#).
- [WSS Kerberos token](#).
- [CORBA Principal](#).
- [HTTP Basic Authentication](#).
- [X.509 certificate](#).
- [CSI authorization over transport](#).
- [CSI identity assertion](#).
- [SSO token](#).

---

### WSS username token

The Web service security (WSS) UsernameToken is a username/password combination that can be sent in a SOAP header. The specification of WSS UsernameToken is contained in the [WSS UsernameToken Profile 1.0](#) document from [OASIS](#) ([www.oasis-open.org](http://www.oasis-open.org)).

This type of credential is available for the SOAP binding in combination with any kind of Artix transport.

---

### WSS Kerberos token

The WSS Kerberos specification is used to send a Kerberos security token in a SOAP header. The implementation is based on the Kerberos Token Profile v1.0 specification ([wss-kerberos-token-profile-1.0](#)). If you use Kerberos, you must also configure the Artix security service to use the Kerberos adapter.

This type of credential is available for the SOAP binding in combination with any kind of Artix transport.

---

### CORBA Principal

The CORBA Principal is a legacy feature originally defined in the early versions of the CORBA GIOP specification. The CORBA Principal is effectively just a username (no password can be propagated).

This type of credential is available only for the CORBA binding and for SOAP over HTTP.

---

**HTTP Basic Authentication**

HTTP Basic Authentication is used to propagate username/password credentials in a HTTP header.

This type of credential is available to any HTTP-compatible binding.

---

**X.509 certificate**

Two different kinds of X.509 certificate-based authentication are provided, depending on the type of Artix binding, as follows:

- *HTTP-compatible binding*—in this case, the common name (CN) is extracted from the X.509 certificate’s subject DN. A combination of the common name and a default password is then sent to the Artix security service to be authenticated.
- *CORBA binding*—in this case, authentication is based on the entire X.509 certificate, which is sent to the Artix security service to be authenticated.

This type of credential is available to any transport that uses SSL/TLS.

---

**CSI authorization over transport**

The OMG’s Common Secure Interoperability (CSI) specification defines an *authorization over transport* mechanism, which passes username/password data inside a GIOP service context. This kind of authentication is available only for the CORBA binding.

This type of credential is available only for the CORBA binding.

---

**CSI identity assertion**

The OMG’s Common Secure Interoperability (CSI) specification also defines an *identity assertion* mechanism, which passes username data (no password) inside a GIOP service context. The basic idea behind CSI identity assertion is that the request message comes from a secure peer that can be trusted to assert the identity of a user. This kind of authentication is available only for the CORBA binding.

This type of credential is available only for the CORBA binding.

---

**SSO token**

An SSO token is propagated in the context of a system that uses *single sign-on*. For details of the Artix single sign-on feature, see [“Single Sign-On” on page 389](#).

---

## Protocol Layers

---

### Overview

Within the Artix security architecture, each binding type consists of a stack of protocol layers, where a protocol layer is typically implemented as a distinct Artix plug-in. This subsection describes the protocol layers for the following binding types:

- [HTTP-compatible binding](#).
- [SOAP binding](#).
- [CORBA binding](#).

---

### HTTP-compatible binding

*HTTP-compatible* means any Artix binding that can be layered on top of the HTTP protocol. [Figure 10](#) shows the protocol layers and the kinds of authentication available to a HTTP-compatible binding.

**Figure 10:** *Protocol Layers in a HTTP-Compatible Binding*

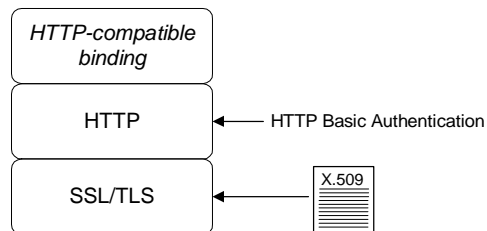

**SOAP binding**

The SOAP binding is a specific example of a HTTP-compatible binding. The SOAP binding is special, because it defines several additional credentials that can be propagated only in a SOAP header. Figure 11 shows the protocol layers and the kinds of authentication available to the SOAP binding over HTTP.

**Figure 11:** *Protocol Layers in a SOAP Binding*

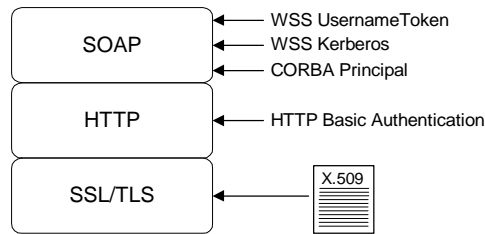

**CORBA binding**

For the CORBA binding, there are only two protocol layers (CORBA binding and IIOP/TLS). This is because CORBA is compatible with only one kind of message format (that is, GIOP). Figure 12 shows the protocol layers and the kinds of authentication available to the CORBA binding.

**Figure 12:** *Protocol Layers in a CORBA Binding*

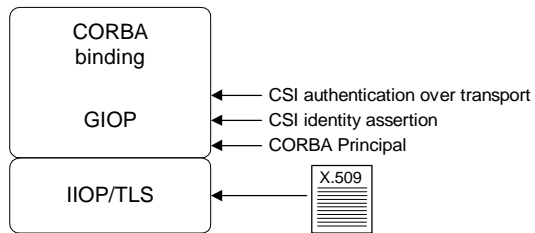

---

# Security Layer

---

## Overview

The *security layer* is responsible for implementing a variety of different security features with the exception, however, of propagating security credentials, which is the responsibility of the protocol layers. The security layer is at least partially responsible for implementing the following security features:

- [Authentication](#).
- [Authorization](#).
- [Single sign-on](#).

---

## Authentication

On the server side, the security layer selects one of the client credentials (a server can receive more than one kind of credentials from a client) and calls the central Artix security service to authenticate the credentials. If the authentication call succeeds, the security layer proceeds to make an authorization check; otherwise, an exception is thrown back to the client.

---

## Authorization

The security layer makes an authorization check by matching a user's roles and realms against the ACL entries in an *action-role mapping file*. If the user does not have permission to invoke the current action (that is, WSDL operation), an exception is thrown back to the client.

---

## Single sign-on

Single sign-on is an optional feature that increases security by reducing the number of times that a user's credentials are sent across the network. The security layer works in tandem with the login service to provide the single sign-on feature.

---

## Artix security plug-in

The Artix security plug-in provides the security layer for all Artix bindings except CORBA. The ASP security layer is loaded, if `artix_security` is listed in the `orb_plugins` list in the Artix domain configuration, `artix.cfg`.

---

## GSP security plug-in

The GSP security plug-in provides the security layer for the CORBA binding only. The GSP security layer is loaded, if `gsp` is listed in the `orb_plugins` list in the Artix domain configuration, `artix.cfg`.

## Using Multiple Bindings

### Overview

Figure 13 shows an example of an advanced application that uses multiple secure bindings.

**Figure 13:** Example of an Application with Multiple Bindings

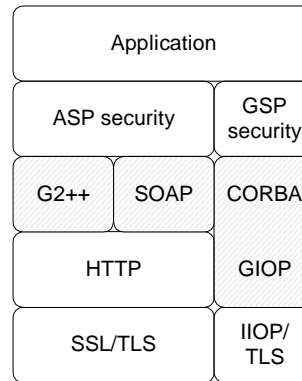

This type of application might be used as a bridge, for example, to link a CORBA domain to a SOAP domain. Alternatively, the application might be a server designed as part of a migration strategy, where the server can support requests in multiple formats, such as G2++, SOAP, or CORBA.

### Example bindings

The following bindings are used in the application shown in Figure 13:

- G2++—consisting of the following layers: ASP security, G2++ binding, HTTP, SSL/TLS.
- SOAP—consisting of the following layers: ASP security, SOAP binding, HTTP, SSL/TLS.
- CORBA—consisting of the following layers: GSP security, CORBA binding, GIOP, IIOP/TLS.



---

# Caching of Credentials—C++ Runtime

---

## Overview

To improve the performance of servers within the Artix Security Framework, both the GSP plug-in (CORBA binding only) and the artix security plug-in (C++ runtime) implement caching of credentials (that is, the authentication and authorization data received from the Artix security service).

The credentials cache reduces a server's response time by reducing the number of remote calls to the Artix security service. On the first call from a given user, the server calls the Artix security service and caches the received credentials. On subsequent calls from the same user, the cached credentials are used, thereby avoiding a remote call to Artix security service.

---

## Cache time-out

The cache can be configured to time-out credentials, forcing the server to call the Artix security service again after using cached credentials for a certain period.

---

## Cache size

The cache can also be configured to limit the number of stored credentials.

---

## GSP configuration variables

The following variables configure the credentials cache for CORBA bindings:

`plugins:gsp:authentication_cache_size`

The maximum number of credentials stored in the authentication cache. If this size is exceeded the oldest credential in the cache is removed.

A value of -1 (the default) means unlimited size. A value of 0 means disable the cache.

`plugins:gsp:authentication_cache_timeout`

The time (in seconds) after which a credential is considered *stale*. Stale credentials are removed from the cache and the server must re-authenticate with the Artix security service on the next call from that user.

A value of -1 (the default) means an infinite time-out. A value of 0 means disable the cache.

## ASP configuration variables

The following variables configure the credentials cache for all non-CORBA bindings:

`plugins:asp:authentication_cache_size`

The maximum number of credentials stored in the authentication cache. If this size is exceeded the oldest credential in the cache is removed.

A value of -1 (the default) means unlimited size. A value of 0 means disable the cache.

`plugins:asp:authentication_cache_timeout`

The time (in seconds) after which a credential is considered *stale*. Stale credentials are removed from the cache and the server must re-authenticate with the Artix security service on the next call from that user.

A value of -1 (the default) means an infinite time-out. A value of 0 means disable the cache.

# Security for HTTP-Compatible Bindings

*This chapter describes the security features supported by the Artix HTTP transport. These security features are available to any Artix binding that can be layered on top of the HTTP transport.*

---

**In this chapter**

This chapter discusses the following topics:

<a href="#">Overview of HTTP Security</a>	page 92
<a href="#">Securing HTTP Communications with TLS—Java Runtime</a>	page 95
<a href="#">Securing HTTP Communications with TLS—C++ Runtime</a>	page 103
<a href="#">HTTP Basic Authentication—C++ Runtime</a>	page 114
<a href="#">X.509 Certificate-Based Authentication—Java Runtime</a>	page 118
<a href="#">X.509 Certificate-Based Authentication—C++ Runtime</a>	page 123

# Overview of HTTP Security

## Overview

Figure 14 gives an overview of HTTP security within the Artix security framework, showing the various security layers (security layer, binding layer, HTTP, and SSL/TLS) and the different authentication types associated with the security layers. Because many different binding types (for example, SOAP, tagged or fixed) can be layered on top of HTTP, Figure 14 does not specify a particular binding layer. Any HTTP-compatible binding could be substituted into this architecture.

**Figure 14:** *HTTP-Compatible Binding Security Layers*

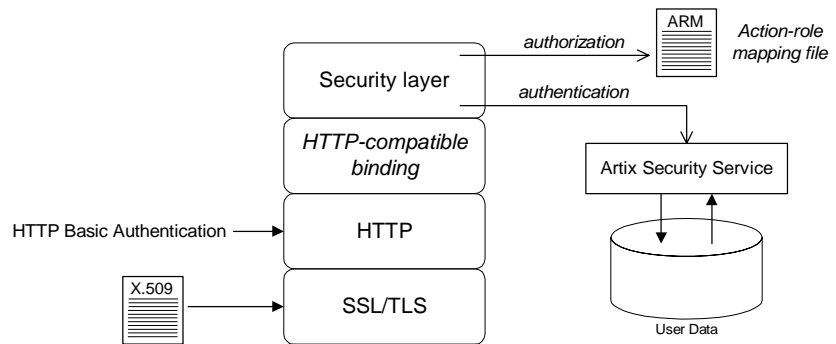

## Security layers

As shown in Figure 14, a HTTP-compatible binding has the following security layers:

- [SSL/TLS layer](#).
- [HTTP layer](#).
- [HTTP-compatible binding layer](#).
- [Security layer](#).

## SSL/TLS layer

The SSL/TLS layer provides guarantees of confidentiality, message integrity, and authentication (using X.509 certificates).

---

**HTTP layer**

The HTTP layer supports the sending of username/password data in the HTTP message header—that is, *HTTP Basic Authentication*.

In the Artix C++ runtime, the HTTP/S protocol is implemented by the following plug-ins:

- `at_http` plug-in—this plug-in is a thin layer that integrates the other two plug-ins, `http` and `https`, with the Artix core. The `at_http` plug-in is automatically loaded, if either the `<http-conf:client>` or `<http-conf:server>` tags appear amongst the WSDL port settings.
- `http` plug-in—implements *insecure* HTTP only. The `http` plug-in is automatically loaded by the `at_http` plug-in.
- `https` plug-in—implements *secure* HTTPS only. The `https` plug-in must be added explicitly to the `orb_plugins` list in order to load.

---

**HTTP-compatible binding layer**

The HTTP-compatible binding layer could provide additional security features (for example, propagation of security credentials), depending on the type of binding. The following binding types are HTTP-compatible:

- SOAP binding.
- XML format binding.
- Fixed record length binding.
- Tagged data binding.
- MIME binding.

---

**Security layer**

The Security layer is implemented by the Artix security plug-in, which provides authentication and authorization checks for all binding types, except the CORBA binding, as follows:

- *Authentication*—by selecting one of the available client credentials and calling out to the Artix security service to check the credentials.
- *Authorization*—by reading an action-role mapping (ARM) file and checking whether a user's roles allow it to perform a particular action.
- *SOAP 1.2 headers (C++ runtime)*—in programs implemented using the C++ runtime, the security layer is also responsible for adding SOAP 1.2 headers on the client side.

---

**Authentication options**

The following authentication options are common to all HTTP-compatible bindings:

- [HTTP Basic Authentication](#).
- [X.509 certificate-based authentication](#).

---

**HTTP Basic Authentication**

HTTP Basic Authentication works by sending a username and password embedded in the HTTP message header. This style of authentication is commonly used by clients running in a Web browser.

For details of HTTP Basic Authentication, see [“HTTP Basic Authentication—C++ Runtime” on page 114](#).

---

**X.509 certificate-based authentication**

X.509 certificate-based authentication is an authentication step that is performed *in addition to* the checks performed at the socket layer during the SSL/TLS security handshake.

For details of X.509 certificate-based authentication, see [“X.509 Certificate-Based Authentication—C++ Runtime” on page 123](#).

---

# Securing HTTP Communications with TLS—Java Runtime

---

## Overview

This subsection describes how to configure the HTTP transport (Java runtime) to use SSL/TLS security, a combination usually referred to as HTTPS. In the Artix Java runtime, HTTPS security is configured by specifying settings in XML configuration files.

The following topics are discussed in this subsection:

- [Generating X.509 certificates.](#)
- [Enabling HTTPS.](#)
- [HTTPS client with no certificate.](#)
- [HTTPS client with certificate.](#)
- [HTTPS server configuration.](#)

---

## Generating X.509 certificates

A basic prerequisite for using SSL/TLS security is to have a collection of X.509 certificates available to identify your server applications and, optionally, your client applications. You can generate X.509 certificates in one of the following ways:

- Use a commercial third-party tool to generate and manage your X.509 certificates.
- Use the free `openssl` utility (which can be downloaded from <http://www.openssl.org>) and the Java `keytool` utility to generate certificates—see “[Use the CA to Create Signed Certificates in a Java Keystore](#)” on page 188.

Whichever approach you use, in the Java runtime it is necessary to deploy X.509 certificate chains and trusted CA certificates in the form of Java keystores. See “[Configuring HTTPS and IOP/TLS Authentication](#)” on page 195 for more details.

## Enabling HTTPS

A prerequisite for enabling HTTPS on a WSDL endpoint is that the endpoint address must be specified to be a HTTPS URL. There are a couple of different locations where the endpoint address is set and these must *all* be modified to use a HTTPS URL.

### HTTPS specified in the WSDL contract

You must specify the endpoint address in the WSDL contract to be a URL with the `https:` prefix, as follows:

```
<wsdl:definitions name="HelloWorld"
  targetNamespace="http://apache.org/hello_world_soap_http"
  xmlns:soap="http://schemas.xmlsoap.org/wsdl/soap/"
  xmlns:wsdl="http://schemas.xmlsoap.org/wsdl/" ... >
  ...
  <wsdl:service name="SOAPService">
    <wsdl:port binding="tns:Greeter_SOAPBinding"
      name="SoapPort">
      <soap:address
        location="https://localhost:9001/SoapContext/SoapPort"/>
      </wsdl:port>
    </wsdl:service>
  </wsdl:definitions>
```

Where the `location` attribute of the `soap:address` element is configured to use a HTTPS URL. For bindings other than SOAP, you would edit the URL appearing in the `location` attribute of the `http:address` element.

### HTTPS specified in the server code

You must also ensure that the URL published in the server code by calling `Endpoint.publish()` is defined with a `https:` prefix. For example:

```
// Java
package demo.hw_https.server;
import javax.xml.ws.Endpoint;

public class Server {
  protected Server() throws Exception {
    Object implementor = new GreeterImpl();
    String address =
      "https://localhost:9001/SoapContext/SoapPort";
    Endpoint.publish(address, implementor);
  }
  ...
}
```



**HTTPS client with no certificate**

For example, consider the configuration for a secure HTTPS client with no certificate. [Example 17](#) shows how to configure such a sample client.

**Example 17: Sample HTTPS Client with No Certificate**

```

<?xml version="1.0" encoding="UTF-8"?>
<beans xmlns="http://www.springframework.org/schema/beans"
xmlns:xsi="http://www.w3.org/2001/XMLSchema-instance"
xmlns:sec="http://cxf.apache.org/configuration/security"
xmlns:http="http://cxf.apache.org/transports/http/configuration"
xmlns:jaxws="http://java.sun.com/xml/ns/jaxws"
xsi:schemaLocation="...">

1  <http:conduit
   name="{http://apache.org/hello_world_soap_http}SoapPort.http-
   conduit">
2  <http:tlsClientParameters>
3  <sec:trustManagers>
   <sec:keyStore type="JKS" password="password"
   file="certs/truststore.jks"/>
   </sec:trustManagers>
4  <sec:cipherSuitesFilter>
   <sec:include>.*_WITH_3DES_.*</sec:include>
   <sec:include>.*_WITH_DES_.*</sec:include>
   <sec:exclude>.*_WITH_NULL_.*</sec:exclude>
   <sec:exclude>.*_DH_anon_.*</sec:exclude>
   </sec:cipherSuitesFilter>
   </http:tlsClientParameters>
</http:conduit>

</beans>

```

The preceding client configuration can be described as follows:

1. The TLS security settings are defined on a specific WSDL port. In this example, the WSDL port being configured has the QName, `{http://apache.org/hello_world_soap_http}SoapPort`.
2. The `http:tlsClientParameters` element contains all of the client's TLS configuration details.
3. The `sec:trustManagers` element is used to specify a list of trusted CA certificates (the client uses this list to decide whether or not to trust certificates received from the server side).

The `file` attribute of the `sec:keyStore` element specifies a Java keystore file, `truststore.jks`, containing one or more trusted CA certificates. The `password` attribute specifies the password required to access the keystore, `truststore.jks`. See [“Specifying Trusted CA Certificates for HTTPS—Java Runtime” on page 207](#).

**Note:** Instead of the `file` attribute, you could specify the location of the keystore using either the `resource` or the `url` attribute. But you must be extremely careful not to load the truststore from an untrustworthy source.

4. The `sec:cipherSuitesFilter` element can be used to narrow the choice of cipher suites that the client is willing to use for a TLS connection. See [“Configuring HTTPS Cipher Suites—Java Runtime” on page 233](#) for details.

## HTTPS client with certificate

For example, consider a secure HTTPS client that is configured to have its own certificate. [Example 18](#) shows how to configure such a sample client.

### Example 18: Sample HTTPS Client with Certificate

```
<?xml version="1.0" encoding="UTF-8"?>
<beans xmlns="http://www.springframework.org/schema/beans"
  xmlns:xsi="http://www.w3.org/2001/XMLSchema-instance"
  xmlns:sec="http://cxf.apache.org/configuration/security"

  xmlns:http="http://cxf.apache.org/transports/http/configuration"
  xmlns:jaxws="http://java.sun.com/xml/ns/jaxws"
  xsi:schemaLocation="...">

  <http:conduit
    name="{http://apache.org/hello_world_soap_http}SoapPort.http-
    conduit">
    <http:tlsClientParameters>
      <sec:trustManagers>
        <sec:keyStore type="JKS" password="password"
          file="certs/truststore.jks"/>
      </sec:trustManagers>
    </http:tlsClientParameters>
  </http:conduit>
</beans>
```

**Example 18:** *Sample HTTPS Client with Certificate*

```

1   <sec:keyManagers keyPassword="password">
2     <sec:keyStore type="JKS" password="password"
      file="certs/wibble.jks"/>
    </sec:keyManagers>
    <sec:cipherSuitesFilter>
      <sec:include>.*_WITH_3DES_.*</sec:include>
      <sec:include>.*_WITH_DES_.*</sec:include>
      <sec:exclude>.*_WITH_NULL_.*</sec:exclude>
      <sec:exclude>.*_DH_anon_.*</sec:exclude>
    </sec:cipherSuitesFilter>
  </http:tlsClientParameters>
</http:conduit>

  <bean id="cxf" class="org.apache.cxf.bus.CXFBusImpl"/>
</beans>

```

The preceding client configuration can be described as follows:

1. The `sec:keyManagers` element is used to attach an X.509 certificate and private key to the client. The password specified by the `keyPassword` attribute is used to decrypt the certificate's private key.
2. The `sec:keyStore` element is used to specify an X.509 certificate and private key that are stored in a Java keystore. This sample declares that the keystore is in Java Keystore format (JKS).

The `file` attribute specifies the location of the keystore file, `wibble.jks`, that contains the client's X.509 certificate chain and private key in a *key entry*. The `password` attribute specifies the keystore password, which is needed to access the contents of the keystore. It is expected that the keystore file contains just one key entry, so there is no need to specify a key alias to identify the entry.

For details of how to create such a keystore file, see [“Use the CA to Create Signed Certificates in a Java Keystore” on page 188](#).

**Note:** Instead of the `file` attribute, you could specify the location of the keystore using either the `resource` or the `url` attribute. But you must be extremely careful not to load the truststore from an untrustworthy source.

**HTTPS server configuration**

For example, consider a secure HTTPS server that requires clients to present an X.509 certificate. [Example 19](#) shows how to configure such a server.

**Example 19: Sample HTTPS Server Configuration**

```

<?xml version="1.0" encoding="UTF-8"?>
<beans xmlns="http://www.springframework.org/schema/beans"
xmlns:xsi="http://www.w3.org/2001/XMLSchema-instance"
xmlns:sec="http://cxf.apache.org/configuration/security"
xmlns:http="http://cxf.apache.org/transport/http/configuration"
xmlns:httpj="http://cxf.apache.org/transport/http-jetty/configuration"
xmlns:jaxws="http://java.sun.com/xml/ns/jaxws"
xsi:schemaLocation="...">

  <httpj:engine-factory bus="cxf">
1    <httpj:engine port="9001">
2      <httpj:tlsServerParameters>
3        <sec:keyManagers keyPassword="password">
4          <sec:keyStore type="JKS" password="password"
            file="certs/cherry.jks"/>
        </sec:keyManagers>
5        <sec:trustManagers>
            <sec:keyStore type="JKS" password="password"
              file="certs/truststore.jks"/>
        </sec:trustManagers>
6        <sec:cipherSuitesFilter>
            <sec:include>.*_WITH_3DES_.*</sec:include>
            <sec:include>.*_WITH_DES_.*</sec:include>
            <sec:exclude>.*_WITH_NULL_.*</sec:exclude>
            <sec:exclude>.*_DH_anon_.*</sec:exclude>
        </sec:cipherSuitesFilter>
7        <sec:clientAuthentication want="true" required="true"/>
      </httpj:tlsServerParameters>
    </httpj:engine>
  </httpj:engine-factory>

  <!-- We need a bean named "cxf" -->
  <bean id="cxf" class="org.apache.cxf.bus.CXFBusImpl"/>
</beans>

```

The preceding server configuration can be described as follows:

1. On the server side, TLS is *not* configured for each WSDL port. Instead of configuring each WSDL port, the TLS security settings are applied to a specific *IP port*, which is 9001 in this example. All of the WSDL ports that share this IP port are thus configured with the same TLS security settings.
2. The `http:tlsServerParameters` element contains all of the server's TLS configuration details.
3. The `sec:keyManagers` element is used to attach an X.509 certificate and private key to the server. The password specified by the `keyPassword` attribute is used to decrypt the certificate's private key.
4. The `sec:keyStore` element is used to specify an X.509 certificate and private key that are stored in a Java keystore. This sample declares that the keystore is in Java Keystore format (JKS).

The `file` attribute specifies the location of the keystore file, `cherry.jks`, that contains the client's X.509 certificate chain and private key in a *key entry*. The `password` attribute specifies the keystore password, which is needed to access the contents of the keystore. It is expected that the keystore file contains just one key entry, so there is no need to specify a key alias.

**Note:** Instead of the `file` attribute, you could specify the location of the keystore using either the `resource` or the `url` attribute. But you must be extremely careful not to load the truststore from an untrustworthy source.

For details of how to create such a keystore file, see [“Use the CA to Create Signed Certificates in a Java Keystore” on page 188](#).

5. The `sec:trustManagers` element is used to specify a list of trusted CA certificates (the server uses this list to decide whether or not to trust certificates presented by clients).

The `file` attribute of the `sec:keyStore` element specifies a Java keystore file, `truststore.jks`, containing one or more trusted CA certificates. The `password` attribute specifies the password required to

access the keystore, `truststore.jks`. See [“Specifying Trusted CA Certificates for HTTPS—Java Runtime”](#) on page 207.

**Note:** Instead of the `file` attribute, you could specify the location of the keystore using either the `resource` or the `url` attribute.

6. The `sec:cipherSuitesFilter` element can be used to narrow the choice of cipher suites that the server is willing to use for a TLS connection. See [“Configuring HTTPS Cipher Suites—Java Runtime”](#) on page 233 for details.
7. The `sec:clientAuthentication` element determines the server’s disposition towards the presentation of client certificates. The element has two attributes, as follows:
  - ◆ `want` attribute—if `true`, (the default) the server requests the client to present an X.509 certificate during the TLS handshake; if `false`, the server does *not* request the client to present an X.509 certificate.
  - ◆ `required` attribute—if `true`, the server raises an exception, if a client fails to present an X.509 certificate during the TLS handshake; if `false`, (the default) the server does *not* raise an exception, if the client fails to present an X.509 certificate.

---

# Securing HTTP Communications with TLS—C++ Runtime

---

## Overview

This subsection describes how to configure the HTTP transport (C++ runtime) to use SSL/TLS security, a combination usually referred to as HTTPS. In the Artix C++ runtime, HTTPS security is implemented by a combination of the `at_http` and `https` plug-ins and configured by settings in the `artix.cfg` file.

The following topics are discussed in this subsection:

- [Generating X.509 certificates.](#)
- [Enabling HTTPS.](#)
- [HTTPS client with no certificate.](#)
- [HTTPS client with certificate.](#)
- [HTTPS server configuration.](#)

---

## Generating X.509 certificates

A basic prerequisite for using SSL/TLS security is to have a collection of X.509 certificates available to identify your server applications and, optionally, your client applications. You can generate X.509 certificates in one of the following ways:

- Use a commercial third-party tool to generate and manage your X.509 certificates.
- Use the free `openssl` utility (which can be downloaded from <http://www.openssl.org>)—see “Creating Your Own Certificates” on [page 181](#) for details of how to use it.

## Enabling HTTPS

There are two approaches to enabling HTTPS, depending on whether or not the configuration in the WSDL contract explicitly specifies a HTTPS URL.

### HTTPS specified in the WSDL contract

The usual way to enable HTTPS is by specifying the endpoint address in the WSDL contract as an URL with the `https:` prefix. For example, to enable SOAP over HTTPS, you would specify the endpoint address as follows:

```
<wSDL:definitions name="HelloWorld"
  targetNamespace="http://www.iona.com/hello_world_soap_http"
  xmlns:soap="http://schemas.xmlsoap.org/wsdl/soap/"
  xmlns:wSDL="http://schemas.xmlsoap.org/wsdl/" ... >
  ...
  <wSDL:service name="SOAPService">
    <wSDL:port binding="tns:Greeter_SOAPBinding"
      name="SoapPort">
      <soap:address location="https://localhost:9000"/>
    </wSDL:port>
  </wSDL:service>
</wSDL:definitions>
```

Where the `location` attribute of the `soap:address` element is configured to use a HTTPS URL. For bindings other than SOAP, you would edit the URL appearing in the `location` attribute of the `http:address` element.

### HTTPS not specified in the WSDL contract

If the endpoint address in the WSDL contract is specified as an URL with the `http:` prefix (insecure HTTP), it is possible to force the endpoint to use SSL/TLS security by editing the Artix configuration file, setting `plugins:at_http:client:use_secure_sockets` to `true` on the client side and `plugins:at_http:server:use_secure_sockets` to `true` on the server side. In general, however, it is better to specify the HTTPS protocol by modifying the URL in the WSDL contract (the first approach).



**HTTPS client with no certificate**

For example, consider the configuration for a secure HTTPS client with no certificate. [Example 20](#) shows how to configure such a sample client.

**Example 20:** *Sample HTTPS Client with No Certificate*

```

# Artix Configuration File
...
# General configuration at root scope.
...
my_secure_apps {
  # Common SSL/TLS configuration settings.
1  orb_plugins = ["xml_log_stream", ..., "at_http", "https"];

  binding:client_binding_list = ["GIOP+EGMIOP",
  "OTS+TLS_Coloc+POA_Coloc", "TLS_Coloc+POA_Coloc",
  "OTS+POA_Coloc", "POA_Coloc", "GIOP+SHMIOP",
  "CSI+OTS+GIOP+IIOP_TLS", "OTS+GIOP+IIOP_TLS",
  "CSI+GIOP+IIOP_TLS", "GIOP+IIOP_TLS", "CSI+OTS+GIOP+IIOP",
  "OTS+GIOP+IIOP", "CSI+GIOP+IIOP", "GIOP+IIOP"];

2  policies:https:trusted_ca_list_policy =
  "ArtixInstallDir\cxx_java\samples\security\certificates\tls\x
  509\trusted_ca_lists\ca_list1.pem";

3  policies:https:mechanism_policy:protocol_version = "SSL_V3";
  policies:https:mechanism_policy:ciphersuites =
  ["RSA_WITH_RC4_128_SHA", "RSA_WITH_RC4_128_MD5"];

4  event_log:filters = ["IT_ATLI_TLS=*", "IT_IIOP=*",
  "IT_IIOP_TLS=*", "IT_TLS=*"];
  ...
  my_client {
    # Specific HTTPS client configuration settings
5    principal_sponsor:use_principal_sponsor = "false";

6    policies:client_secure_invocation_policy:requires =
    ["Confidentiality", "Integrity", "DetectReplay",
    "DetectMisordering", "EstablishTrustInTarget"];
    policies:client_secure_invocation_policy:supports =
    ["Confidentiality", "Integrity", "DetectReplay",
    "DetectMisordering", "EstablishTrustInTarget"];
  };
};
...

```

The preceding client configuration can be described as follows:

1. The `at_http` and `https` plug-ins together provide support for the HTTP and HTTPS protocols. You can optionally include these plug-ins in the `orb_plugins` list. If they are not explicitly listed, Artix will automatically load them when necessary.

**Note:** Loading the `https` plug-in is *not* sufficient to make a service secure. You must also configure the endpoints to have HTTPS URLs in the WSDL contract—see [“Enabling HTTPS” on page 104](#).

If you plan to use the full Artix Security Framework, you should include the ASP plug-in, `artix_security`, in the ORB plug-ins list as well.

2. A HTTPS application needs a list of trusted CA certificates, which it uses to determine whether or not to trust certificates received from other HTTPS applications. You must, therefore, edit the `policies:https:trusted_ca_list_policy` variable to point at a list of trusted certificate authority (CA) certificates. See [“Specifying Trusted CA Certificates” on page 206](#).
3. The mechanism policy specifies the default security protocol version and the available cipher suites—see [“Specifying Cipher Suites” on page 257](#).
4. This line enables console logging for security-related events, which is useful for debugging and testing. Because there is a performance penalty associated with this option, you might want to comment out or delete this line in a production system.
5. The SSL/TLS principal sponsor is a mechanism that can be used to specify an application’s own X.509 certificate. Because this client configuration does not use a certificate, the principal sponsor is disabled by setting `principal_sponsor:use_principal_sponsor` to `false`.
6. The following two lines set the *required* options and the *supported* options for the HTTPS client secure invocation policy. In this example, the policy is set as follows:
  - ◆ Required options—the options shown here ensure that the client can open only secure HTTPS connections.

- ◆ Supported options—the options shown include all of the association options, except for the `EstablishTrustInClient` option. The client cannot support `EstablishTrustInClient`, because it has no X.509 certificate.

## HTTPS client with certificate

For example, consider a secure HTTPS client that is configured to have its own certificate. [Example 21](#) shows how to configure such a sample client.

### Example 21: Sample HTTPS Client with Certificate

```
# Artix Configuration File
...
# General configuration at root scope.
...
my_secure_apps {
    # Common SSL/TLS configuration settings.
    orb_plugins = ["xml_log_stream", ..., "at_http", "https"];

    binding:client_binding_list = ["GIOP+EGMIOP",
    "OTS+TLS_Coloc+POA_Coloc", "TLS_Coloc+POA_Coloc",
    "OTS+POA_Coloc", "POA_Coloc", "GIOP+SHMIOP",
    "CSI+OTS+GIOP+IIOP_TLS", "OTS+GIOP+IIOP_TLS",
    "CSI+GIOP+IIOP_TLS", "GIOP+IIOP_TLS", "CSI+OTS+GIOP+IIOP",
    "OTS+GIOP+IIOP", "CSI+GIOP+IIOP", "GIOP+IIOP"];

    policies:https:trusted_ca_list_policy =
    "ArtixInstallDir\cxx_java\samples\security\certificates\tls\x
    509\trusted_ca_lists\ca_list1.pem";

    policies:https:mechanism_policy:protocol_version = "SSL_V3";
    policies:https:mechanism_policy:ciphersuites =
    ["RSA_WITH_RC4_128_SHA", "RSA_WITH_RC4_128_MD5"];

    event_log:filters = ["IT_ATLI_TLS=*", "IT_IIOP=*",
    "IT_IIOP_TLS=*", "IT_TLS=*"];
    ...
    my_client {
        # Specific HTTPS client configuration settings
        1 principal_sponsor:use_principal_sponsor = "true";
        2 principal_sponsor:auth_method_id = "pkcs12_file";
        3 principal_sponsor:auth_method_data =
        ["filename=C:\artix_30\artix\3.0\demos\security\certificates\
        openssl\x509\certs\testaspen.p12"];
    }
}
```

**Example 21:** *Sample HTTPS Client with Certificate*

```

4      policies:client_secure_invocation_policy:requires =
["Confidentiality", "Integrity", "DetectReplay",
"DetectMisordering", "EstablishTrustInTarget"];
      policies:client_secure_invocation_policy:supports =
["Confidentiality", "Integrity", "DetectReplay",
"DetectMisordering", "EstablishTrustInTarget",
"EstablishTrustInClient"];
    };
    ...

```

The preceding client configuration can be described as follows:

1. The SSL/TLS principal sponsor is a mechanism that can be used to specify an application's own X.509 certificate. The principal sponsor is enabled by setting `principal_sponsor:use_principal_sponsor` to `true`.
2. This line specifies that the X.509 certificate is contained in a PKCS#12 file. For alternative methods, see [“Specifying an Application's Own Certificate” on page 216](#).
3. Specify the X.509 certificate location by editing the `filename` value to point at a custom X.509 certificate file, which should be in PKCS#12 format—see [“Specifying an Application's Own Certificate” on page 216](#) for more details.

For details of how to specify the certificate's pass phrase, see [“Deploying Own Certificate for HTTPS—C++ Runtime” on page 219](#).

4. The following two lines set the *required* options and the *supported* options for the client secure invocation policy. In this example, the policy is set as follows:
  - ◆ Required options—the options shown here ensure that the client can open only secure HTTPS connections.
  - ◆ Supported options—the association options shown here include the `EstablishTrustInClient` option. This association option must be supported when the client has an X.509 certificate.

Alternatively, you could configure security for a HTTPS client by editing the port settings in the WSDL contract (but only for *mutual authentication*).

[Example 22](#) shows how to configure the client side of a HTTPS connection in Artix, in the case of mutual authentication.

**Example 22:** *WSDL Contract for HTTPS Client with Certificate*

```
<definitions name="HelloWorldService"
  targetNamespace="http://xmlbus.com/HelloWorld"
  xmlns:soap="http://schemas.xmlsoap.org/wsdl/soap/"
  xmlns:http-conf="http://schemas.iona.com/transport/http/configuration" ... >
  ...
  <service name="HelloWorldService">
    <port binding="tns:HelloWorldPortBinding"
      name="HelloWorldPort">
      <soap:address location="https://localhost:55012"/>
      <http-conf:client
        UseSecureSockets="true"
        TrustedRootCertificates="../certificates/openssl/x509/ca/cacert.
1 ClientCertificate="../certificates/openssl/x509/certs/client_cer
2 t.p12"
        ClientPrivateKeyPassword="ClientPrivKeyPass"
      />
    </port>
  </service>
</definitions>
```

The preceding WSDL contract can be described as follows:

1. The `ClientCertificate` attribute specifies the client's own certificate in PKCS#12 format.
2. The `ClientPrivateKeyPassword` attribute specifies the password to decrypt the contents of the `ClientCertificate` file.

**Note:** The presence of the private key password in the WSDL contract file implies that this file must be read and write-protected to prevent unauthorized users from obtaining the password.

**WARNING:** If you include security settings in the WSDL contract and you have loaded the WSDL publish plug-in, it is recommended that you configure the WSDL publishing service to be secure. See [“Publishing WSDL Securely—C++ Runtime” on page 419](#).

**HTTPS server configuration**

Generally speaking, it is rarely necessary to configure such a thing as a *pure server* (that is, a server that never makes any requests of its own). Most real servers are applications that act in both a server role and a client role. The sample server described here combines the following qualities: in the server role, the application requests clients to send a certificate; in the client role, the application requires security and includes a certificate.

[Example 23](#) shows how to configure such a sample server.

**Example 23: Sample HTTPS Server Configuration**

```

# Artix Configuration File
...
# General configuration at root scope.
...
my_secure_apps {
1   # Common SSL/TLS configuration settings.
    ...
    my_server {
2       # Specific HTTPS server configuration settings
        policies:target_secure_invocation_policy:requires =
["Confidentiality", "Integrity", "DetectReplay",
"DetectMisordering"];
        policies:target_secure_invocation_policy:supports =
["EstablishTrustInClient", "Confidentiality", "Integrity",
"DetectReplay", "DetectMisordering",
"EstablishTrustInTarget"];
3
4       principal_sponsor:use_principal_sponsor = "true";
5       principal_sponsor:auth_method_id = "pkcs12_file";
        principal_sponsor:auth_method_data =
["filename=CertsDir\server_cert.pl2"];

        # Specific HTTPS client configuration settings
6       policies:client_secure_invocation_policy:requires =
["Confidentiality", "Integrity", "DetectReplay",
"DetectMisordering", "EstablishTrustInTarget"];
        policies:client_secure_invocation_policy:supports =
["Confidentiality", "Integrity", "DetectReplay",
"DetectMisordering", "EstablishTrustInClient",
"EstablishTrustInTarget"];
    };
};
...

```

The preceding server configuration can be described as follows:

1. You can use the same common SSL/TLS settings here as described in the preceding [“HTTPS client with no certificate” on page 105](#).
2. The following two lines set the *required* options and the *supported* options for the target secure invocation policy. In this example, the policy is set as follows:
  - ◆ Required options—the options shown here ensure that the server accepts only secure HTTPS connection attempts.
  - ◆ Supported options—all of the target association options are supported.
3. A secure server must always be associated with an X.509 certificate. Hence, this line enables the SSL/TLS principal sponsor, which specifies a certificate for the application.
4. This line specifies that the X.509 certificate is contained in a PKCS#12 file. For alternative methods, see [“Specifying an Application’s Own Certificate” on page 216](#).
5. Specify the location of the X.509 certificate file, by editing the `filename` value to point at a custom X.509 certificate, which should be in PKCS#12 format—see [“Specifying an Application’s Own Certificate” on page 216](#) for more details.

For details of how to specify the certificate’s pass phrase, see [“Deploying Own Certificate for HTTPS—C++ Runtime” on page 219](#).

6. The following two lines set the *required* options and the *supported* options for the client secure invocation policy. In this example, the policy is set as follows:
  - ◆ Required options—the options shown here ensure that the application can open only secure SSL/TLS connections to other servers.
  - ◆ Supported options—all of the client association options are supported. In particular, the `EstablishTrustInClient` option is supported when the application is in a client role, because the application has an X.509 certificate.

Alternatively, you could configure security for a HTTPS server by editing the port settings in the WSDL contract (but only for *mutual authentication*).

[Example 24](#) shows how to configure the server side of a HTTPS connection for mutual authentication in Artix.

**Example 24:** *WSDL Contract with Server HTTPS Configuration*

```

<definitions name="HelloWorldService"
  targetNamespace="http://xmlbus.com/HelloWorld"
  xmlns:soap="http://schemas.xmlsoap.org/wsdl/soap/"
  xmlns:http-conf="http://schemas.iona.com/transport/http/configuration" ... >
  ...
  <service name="HelloWorldService">
    <port binding="tns:HelloWorldPortBinding"
      name="HelloWorldPort">
1      <soap:address location="https://localhost:55012"/>
2      <http-conf:server
3        UseSecureSockets="true"
4      ServerCertificate="../certificates/openssl/x509/certs/server_certificate.p12"
5        ServerPrivateKeyPassword="ServerPrivKeyPass"
6      TrustedRootCertificates="../certificates/openssl/x509/ca/cacert.p12"
        />
    </port>
  </service>
</definitions>

```

The preceding WSDL contract can be described as follows:

1. The fact that this is a secure connection is signalled by using `https:` instead of `http:` in the location URL attribute.
2. The `<http-conf:server>` tag contains all the attributes for configuring the server side of the HTTPS connection.
3. If the `UseSecureSockets` attribute is `true`, the server will open a port to listen for secure connections.

**Note:** If `UseSecureSockets` is `false` and the `<soap:address>` location URL begins with `https:`, however, the server will listen for secure connections.



4. The `ServerCertificate` attribute specifies the server's own certificate in PKCS#12 format. For more background details about X.509 certificates, see [“Managing Certificates” on page 171](#).
5. The `ServerPrivateKeyPassword` attribute specifies the password to decrypt the server certificate's private key.

**Note:** The presence of the private key password in the WSDL contract file implies that this file must be read and write-protected to prevent unauthorized users from obtaining the password.

For the same reason, it is also advisable to remove the `<http-conf:server>` tag from the copy of the WSDL contract that is distributed to clients.

6. The file specified by the `TrustedRootCertificates` contains a concatenated list of CA certificates in PKCS#12 format. This attribute value is needed for mutual authentication (for checking the certificates sent by clients).

**WARNING:** If you include security settings in the WSDL contract and you have loaded the WSDL publish plug-in, it is recommended that you configure the WSDL publishing service to be secure. See [“Publishing WSDL Securely—C++ Runtime” on page 419](#).

# HTTP Basic Authentication—C++ Runtime

## Overview

This section describes how to configure an Artix client and server to use HTTP Basic Authentication. With HTTP Basic Authentication, username/password credentials are sent in a HTTP header.

For more details, see the [W3 specification](http://www.w3.org/Protocols/HTTP/1.0/spec.html) (<http://www.w3.org/Protocols/HTTP/1.0/spec.html>) for HTTP/1.0.

## HTTP Basic Authentication client configuration—WSDL file

**Example 25** shows how to configure a client WSDL contract to use HTTP Basic Authentication.

### Example 25: WSDL Contract with Client HTTP Basic Authentication

```

<definitions name="HelloWorldService"
  targetNamespace="http://xmlbus.com/HelloWorld"
  xmlns:soap="http://schemas.xmlsoap.org/wsdl/soap/"
  xmlns:http-conf="http://schemas.iona.com/transport/http/configuration"
1   xmlns:bus-security="http://schemas.iona.com/bus/security"
  ... >
  ...
  <service name="HelloWorldService">
    <port binding="tns:HelloWorldPortBinding"
2      name="HelloWorldPort">
      <soap:address location="https://localhost:55012"/>
      <http-conf:client
3        ...
4        UserName="user_test"
5        Password="user_password"
      />
      <bus-security:security enableSecurity="true" />
    </port>
  </service>
</definitions>

```

The preceding WSDL contract can be described as follows:

1. The `bus-security` namespace prefix is needed for the ASP plug-in settings.
2. In this example, HTTP Basic Authentication is combined with SSL/TLS security (see [“Securing HTTP Communications with TLS—C++ Runtime” on page 103](#)). This ensures that the username and password are transmitted across an encrypted connection, protecting them from snooping.
3. The `UserName` attribute sets the user name for the HTTP Basic Authentication credentials.
4. The `Password` attribute sets the password for the HTTP Basic Authentication credentials.
5. The presence of the `<bus-security:security>` tag ensures that the ASP plug-in, `artix_security`, is loaded into your application. This plug-in is responsible for the authentication and authorization features.

**WARNING:** If you include security settings in the WSDL contract and you have loaded the WSDL publish plug-in, it is recommended that you configure the WSDL publishing service to be secure. See [“Publishing WSDL Securely—C++ Runtime” on page 419](#).

### HTTP Basic Authentication client configuration—principal sponsor

Instead of setting the HTTP Basic Authentication username and password in the WSDL contract, you can specify the username and password in the Artix configuration file using the relevant *principal sponsor* configuration variables. [Example 26](#) shows how to configure the username and password in the Artix configuration file.

**Example 26:** *Artix Configuration with Client HTTPS Basic Authentication*

```
// Artix Configuration File
secure_artix {
    ...
    client {
1      // SSL/TLS Configuration
      ... // (Not shown)
2      // Configure the HTTP/BA Username and Password
      principal_sponsor:http:use_principal_sponsor = "true";
3      principal_sponsor:http:auth_method_id =
        "USERNAME_PASSWORD";
```

**Example 26:** *Artix Configuration with Client HTTPS Basic Authentication*

```

4      principal_sponsor:http:auth_method_data =
        ["username=test_username", "password=test_password"];
        };
    };

```

The preceding configuration can be described as follows:

1. This example assumes that you are using SSL/TLS security to protect the password from snooping. See [“Securing HTTP Communications with TLS—C++ Runtime” on page 103](#) for details.
2. The `principal_sponsor:http:use_principal_sponsor` configuration variable is set to true to enable HTTP feature.
3. The `principal_sponsor:http:auth_method_id` configuration variable selects the type of credential to send in the HTTP header. Currently, the only valid option is `USERNAME_PASSWORD` (equivalent to HTTP Basic Authentication).
4. The `principal_sponsor:http:auth_method_data` configuration variable sets the Basic Authentication username and password.

**HTTP Basic Authentication server configuration**

There is no need to make any modifications to the WSDL contract for servers that support HTTP Basic Authentication.

However, it is necessary to make modifications to the domain configuration file, `artix.cfg` (in the `ArtixInstallDir/cxx_java/etc/domains` directory), as shown in [Example 27](#).

**Example 27:** *Artix Configuration for Server HTTP Basic Authentication*

```

# Artix Configuration File
security_artix {
    ...
    demos
    {
        hello_world
        {
            plugins:artix_security:shlib_name="it_security_plugin";
1      binding:artix:server_request_interceptor_list=
"security";
            binding:client_binding_list = ["OTS+POA_Coloc",
"POA_Coloc", "OTS+GIOP+IIOP", "GIOP+IIOP", "GIOP+IIOP_TLS"];

```

**Example 27:** *Artix Configuration for Server HTTP Basic Authentication*

```

2         orb_plugins = ["xmlfile_log_stream", ..., "at_http",
3         "artix_security", "https"];
4         plugins:is2_authorization:action_role_mapping =
5         "file://ArtixInstallDir/cxx_java/samples/security/full_security/
6         etc/helloworld_action_role_mapping.xml";
7         policies:asp:enable_authorization = "true";
8         plugins:asp:security_level = "MESSAGE_LEVEL";
9         plugins:asp:authentication_cache_size = "5";
10        plugins:asp:authentication_cache_timeout = "10";
11        };
12        ...
13    };
14};

```

The preceding extract from the domain configuration can be explained as follows:

1. The Artix server request interceptor list must include the `security` interceptor, which provides part of the functionality for the Artix security layer.
2. The `orb_plugins` list should include the `artix_security` plug-in, which is responsible for enabling authentication and authorization.
3. The action-role mapping file is used to apply access control rules to the authenticated user. The file determines which actions (that is, WSDL operations) can be invoked by an authenticated user, on the basis of the roles assigned to that user.  
See [“Managing Access Control Lists” on page 351](#) for more details.
4. The `policies:asp:enable_authorization` variable must be set to `true` to enable authorization.
5. The `plugins:asp:security_level` configuration variable specifies the type of credentials authenticated on the server side. The `MESSAGE_LEVEL` security type, selects the username/password credentials from the HTTP Basic Authentication header.
6. The next pair of configuration variables configure the `asp` caching mechanism. For more details, see [“ASP configuration variables” on page 90](#).

---

# X.509 Certificate-Based Authentication— Java Runtime

---

## Overview

This section describes how to enable X.509 certificate authentication in a two-tier client/server scenario for applications based on the Java runtime. In this scenario, the Artix security service authenticates the client's X.509 certificate and retrieves roles and realms based on the identity of the certificate subject. When certificate-based authentication is enabled, the X.509 certificate is effectively authenticated twice, as follows:

- *SSL/TLS-level authentication*—this authentication step occurs during the SSL/TLS handshake and is governed by the HTTPS configuration settings in the application's XML configuration file.
- *Artix security-level authentication and authorization*—this authentication step occurs *after* the SSL/TLS handshake and is performed by the Artix security service working in tandem with the security layer in the Artix server.

### Certificate-based authentication scenario

Figure 15 shows an example of a two-tier system, where authentication of the client's X.509 certificate is integrated with the Artix security service.

**Figure 15:** Overview of Certificate-Based Authentication with HTTPS—Java Runtime

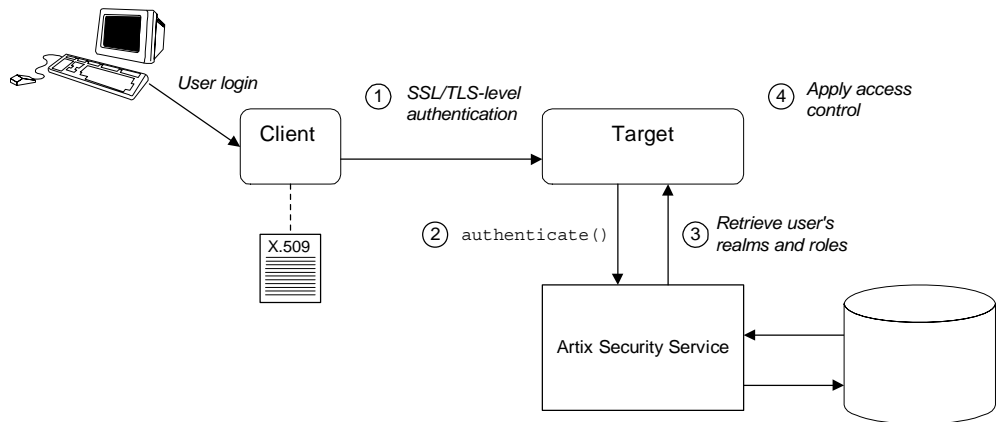

### Scenario description

The scenario shown in Figure 15 can be described as follows:

Stage	Description
1	<p>When the client opens a connection to the server, the client sends its X.509 certificate as part of the SSL/TLS handshake (HTTPS). The server then performs SSL/TLS-level authentication, checking the certificate as follows:</p> <ul style="list-style-type: none"> <li>The certificate is checked against the server's <i>trusted CA list</i> to ensure that it is signed by a trusted certification authority.</li> <li>The server sends a challenge to the client, which requires the client to prove that it possesses the certificate's private key.</li> </ul>

Stage	Description
2	<p>The server performs security layer authentication by calling <code>authenticate()</code> on the Artix security service, passing a copy of the client's certificate to the Artix security service.</p> <p>The details of this authentication step depend on the particular security adapter that is plugged into the Artix security service. For example, the file adapter would authenticate the client certificate as follows:</p> <ul style="list-style-type: none"> <li>• The user's identity is extracted from the certificate's subject DN.</li> <li>• To verify the user's identity, the file adapter compares the client certificate with a cached copy. The authentication succeeds, only if the certificates are equal.</li> </ul>
3	<p>If authentication is successful, the Artix security service returns the user's realms and roles.</p>
4	<p>The ASP security layer controls access to the target's WSDL operations by consulting an <i>action-role mapping file</i> to determine what the user is allowed to do.</p>

### HTTPS prerequisites

In general, a basic prerequisite for using X.509 certificate-based authentication is that both client and server are configured to use HTTPS.

See [“Securing HTTP Communications with TLS—Java Runtime”](#) on page 95.



**Certificate-based authentication security service configuration**

A basic prerequisite for using certificate-based authentication is to configure the security adapter that plugs into the Artix security service. The details of this configuration step are specific to each security adapter. Typically, it involves caching copies of the X.509 certificates for all users with security privileges.

Specific details of how to configure each adapter for certificate-based authentication are available, as follows:

- *File adapter*—see [“Certificate-based authentication for the file adapter” on page 346](#).
- *LDAP adapter*—see [“Certificate-based authentication for the LDAP adapter” on page 349](#).
- *Custom adapter*—see [“Developing an iSF Adapter” on page 579](#).

**Certificate-based authentication client configuration**

To enable certificate-based authentication on the client side, it is sufficient for the client to be configured to use HTTPS, with its own certificate. For example, see [“HTTPS client with certificate” on page 98](#).

**Certificate-based authentication server configuration**

A prerequisite for using certificate-based authentication on the server side is that the server is configured to use HTTPS. For example, see [“HTTPS server configuration” on page 100](#).

A second prerequisite on the server side is that the server is configured to connect to the Artix security service. For example, see [“Connecting to the Artix Security Service” on page 364](#).

Additionally, on the server side it is necessary to configure the security layer to authenticate certificates by editing the XML configuration file, as shown in [Example 28](#).

**Example 28:** *Credential Authentication Element in a Server*

```

1 <beans xmlns="http://www.springframework.org/schema/beans"
  xmlns:jaxws="http://cxf.apache.org/jaxws"
  xmlns:security="http://schemas.ionas.com/soa/security-config"
  ... >
  ...
  <jaxws:endpoint name="{Namespace}TargetPort"
    createdFromAPI="true" >

```

**Example 28:** *Credential Authentication Element in a Server*

```

2       <jaxws:features>
3         <security:TLSSAuthServerConfig
4           aclURL="ACLFile"
5           aclServerName="ServerName"
           authorizationRealm="RealmName"
         />
       </jaxws:features>
     </jaxws:endpoint>
     ...
</beans>

```

The preceding XML configuration can be explained as follows:

1. The authentication feature is attached to the endpoint (WSDL port) specified by the `name` attribute of the `jaxws:endpoint` element, where the endpoint name is specified in QName format.

**Note:** You must specify the authentication feature *separately* for each endpoint that you want to protect with authentication and authorization.

2. The `security:TLSSAuthServerConfig` element enables authentication and authorization of X.509 certificate credentials received through the TLS layer.
3. The `aclURL` attribute specifies the location of an ACL file—for example, `file:etc/acl.xml`. The file determines which actions (that is, WSDL operations) can be invoked by an authenticated user, on the basis of the roles assigned to that user. See [“Managing Access Control Lists” on page 351](#).
4. The `aclServerName` attribute selects a particular rule set from the ACL file by specifying its server name—see [“ACL server name” on page 370](#).
5. The `authorizationRealm` attribute specifies the authorization realm to which this server belongs—see [“Managing Users, Roles and Domains” on page 335](#) for details.

---

# X.509 Certificate-Based Authentication— C++ Runtime

---

## Overview

This section describes how to enable X.509 certificate authentication in a two-tier client/server scenario for applications based on the C++ runtime. In this scenario, the Artix security service authenticates the client's certificate and retrieves roles and realms based on the identity of the certificate subject. When certificate-based authentication is enabled, the X.509 certificate is effectively authenticated twice, as follows:

- *SSL/TLS-level authentication*—this authentication step occurs during the SSL/TLS handshake and is governed by the HTTPS configuration settings in the Artix configuration file, `artix.cfg`.
- *Artix security-level authentication and authorization*—this authentication step occurs after the SSL/TLS handshake and is performed by the Artix security service working in tandem with the `artix_security` plug-in.

**Certificate-based authentication scenario**

Figure 16 shows an example of a two-tier system, where authentication of the client's X.509 certificate is integrated with the Artix security service.

**Figure 16:** Overview of Certificate-Based Authentication with HTTPS

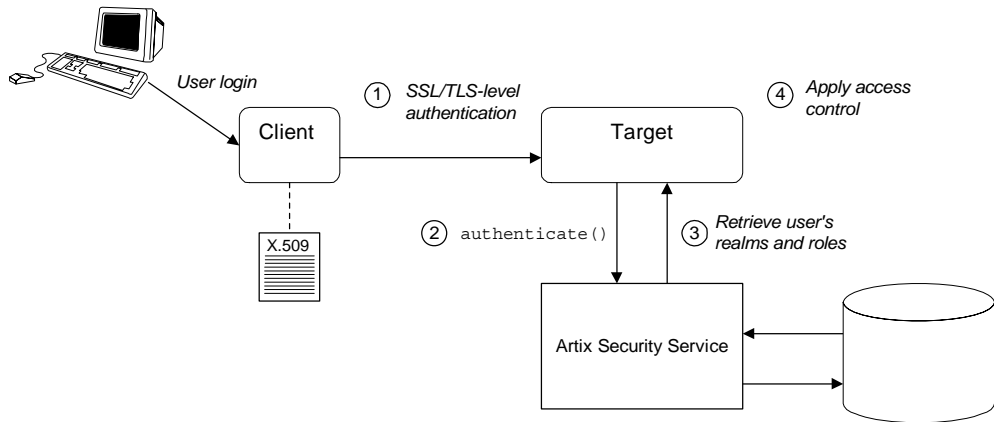

**Scenario description**

The scenario shown in Figure 16 can be described as follows:

Stage	Description
1	When the client opens a connection to the server, the client sends its X.509 certificate as part of the SSL/TLS handshake (HTTPS). The server then performs SSL/TLS-level authentication, checking the certificate as follows: <ul style="list-style-type: none"> <li>The certificate is checked against the server's <i>trusted CA list</i> to ensure that it is signed by a trusted certification authority.</li> <li>The server sends a challenge to the client, which requires the client to prove that it possesses the certificate's private key.</li> </ul>

Stage	Description
2	<p>The server performs security layer authentication by calling <code>authenticate()</code> on the Artix security service, passing a copy of the client's certificate to the Artix security service.</p> <p>The details of this authentication step depend on the particular security adapter that is plugged into the Artix security service. For example, the file adapter would authenticate the client certificate as follows:</p> <ul style="list-style-type: none"> <li>• The user's identity is extracted from the certificate's subject DN.</li> <li>• To verify the user's identity, the file adapter compares the client certificate with a cached copy. The authentication succeeds, only if the certificates are equal.</li> </ul>
3	<p>If authentication is successful, the Artix security service returns the user's realms and roles.</p>
4	<p>The ASP security layer controls access to the target's WSDL operations by consulting an <i>action-role mapping file</i> to determine what the user is allowed to do.</p>

**Credentials priority**

When performing authentication at the Artix security level, the X.509 certificate credentials have a *lower* priority than HTTP Basic Authentication credentials. Hence, if both HTTP Basic Authentication credentials and X.509 certificate credentials are presented, the credentials from HTTP Basic Authentication are used to perform authentication and authorization at the Artix security layer.

**HTTPS prerequisites**

In general, a basic prerequisite for using X.509 certificate-based authentication is that both client and server are configured to use HTTPS. See [“Securing HTTP Communications with TLS—C++ Runtime” on page 103](#).

**Certificate-based authentication security service configuration**

A basic prerequisite for using certificate-based authentication is to configure the security adapter that plugs into the Artix security service. The details of this configuration step are specific to each security adapter. Typically, it involves caching copies of the X.509 certificates for all users with security privileges.

Specific details of how to configure each adapter for certificate-based authentication are available, as follows:

- *File adapter*—see [“Certificate-based authentication for the file adapter” on page 346](#).
- *LDAP adapter*—see [“Certificate-based authentication for the LDAP adapter” on page 349](#).
- *Custom adapter*—see [“Developing an iSF Adapter” on page 579](#).

**Certificate-based authentication client configuration**

To enable certificate-based authentication on the client side, it is sufficient for the client to be configured to use HTTPS with its own certificate. For example, see [“HTTPS client with certificate” on page 107](#).

**Certificate-based authentication server configuration**

A prerequisite for using certificate-based authentication on the server side is that the server's WSDL contract is configured to use HTTPS. For example, see [“HTTPS server configuration” on page 110](#).

Additionally, on the server side it is also necessary to configure the ASP security layer by editing the Artix configuration file, as shown in [Example 29](#).

**Example 29: Artix Configuration for X.509 Certificate-Based Authentication**

```

# Artix Configuration File
security_artix {
  ...
  demos
  {
    hello_world
    {
      plugins:artix_security:shlib_name =
1  "it_security_plugin";
      binding:artix:server_request_interceptor_list=
      "security";
    }
  }
}

```

**Example 29:** *Artix Configuration for X.509 Certificate-Based Authentication*

```

binding:client_binding_list = ["OTS+POA_Coloc",
"POA_Coloc", "OTS+GIOP+IIOP", "GIOP+IIOP", "GIOP+IIOP_TLS"];
2 orb_plugins = ["xmlfile_log_stream", ..., "at_http",
"artix_security", "https"];
3 plugins:is2_authorization:action_role_mapping =
"file://ArtixInstallDir/cxx_java/samples/security/full_security/etc/helloworld_action_role_mapping.xml";
4 policies:asp:enable_authorization = "true";
5 plugins:asp:security_level = "MESSAGE_LEVEL";
6 plugins:asp:authentication_cache_size = "5";
plugins:asp:authentication_cache_timeout = "10";
7 plugins:asp:enable_security_service_cert_authentication = "true";
8
# SSL/TLS Settings for HTTPS Transport
...
};
...
};
};

```

The preceding extract from the domain configuration can be explained as follows:

1. The Artix server request interceptor list must include the `security` interceptor, which provides part of the functionality for the Artix security layer.
2. The `orb_plugins` list should include the `artix_security` plug-in, which is responsible for enabling authentication and authorization. You can optionally include the `https` plug-in, which implements the HTTPS transport protocol (if you don't include it here, it will be loaded dynamically in any case).
3. The action-role mapping file is used to apply access control rules to the authenticated user. The file determines which actions (that is, WSDL operations) can be invoked by an authenticated user, on the basis of the roles assigned to that user.  
See [“Managing Access Control Lists” on page 351](#) for more details.
4. `policies:asp:enable_authorization` variable must be set to `true` to enable authorization.

5. The `plugins:asp:security_level` configuration variable specifies whether the credentials are taken from a request-level header or from a transport-level header. By setting the security level to `MESSAGE_LEVEL`, you indicate that the credentials are taken either from HTTP Basic Authentication credentials or from an X.509 certificate at the SSL/TLS layer.
6. The next pair of configuration variables configure the ASP caching mechanism. For more details, see [“ASP configuration variables” on page 90](#).
7. The `plugins:asp:enable_security_service_cert_authentication` variable must be set to `true` in order to enable X.509 certificate authentication at the Artix security level.
8. You also need to include the settings for configuring the SSL/TLS layer. See [“HTTPS server configuration” on page 110](#) for details.



# Security for SOAP Bindings

*This chapter describes the security features that are specific to the SOAP binding—for example, such as security credentials that can be propagated in a SOAP header.*

---

**In this chapter**

This chapter discusses the following topic:

<a href="#">Overview of SOAP Security</a>	<a href="#">page 130</a>
<a href="#">WSS X.509 Certificates and Authentication—C++ Runtime</a>	<a href="#">page 135</a>

# Overview of SOAP Security

## Overview

Figure 17 gives an overview of security for a SOAP binding within the Artix security framework. SOAP security consists of four different layers (SSL/TLS, HTTP, SOAP, and security layer) and support is provided for several different types of credentials. Figure 17 shows how the different credential types are associated with the different security layers.

**Figure 17:** Overview of Security for SOAP Bindings

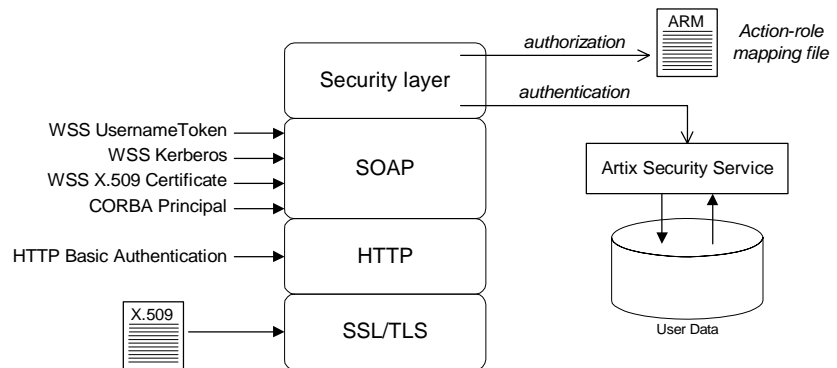

## Security layers

As shown in Figure 17, the SOAP binding includes the following security layers:

- [SSL/TLS layer](#).
- [HTTP layer](#).
- [SOAP layer](#).
- [Security layer](#).

## SSL/TLS layer

The SSL/TLS layer provides the SOAP binding with message encryption, message integrity and authentication using X.509 certificates.

For details of how to enable SSL/TLS for HTTP, see [“Securing HTTP Communications with TLS—Java Runtime”](#) on page 95 and [“Securing HTTP Communications with TLS—C++ Runtime”](#) on page 103.

---

**HTTP layer**

The HTTP layer provides a means of sending username/password credentials in a HTTP header (HTTP Basic Authentication). The HTTP layer relies on SSL/TLS to prevent password snooping.

---

**SOAP layer**

The SOAP layer can send various credentials (WSS UsernameToken, WSS Kerberos, WSS X.509 certificate, and CORBA Principal) embedded in a SOAP message header. The SOAP layer relies on SSL/TLS to prevent credentials snooping.

**Note:** *C++ runtime only*—The division of labor between the SOAP layer and the security layer differs between SOAP 1.1 and SOAP 1.2, as follows:

- SOAP 1.1—the Artix SOAP plug-in is responsible for inserting and extracting security credentials.
- SOAP 1.2—the Artix security plug-in (ASP security layer) is responsible for inserting and extracting security credentials.

---

**Security layer**

The security layer implements a variety of security features for non-CORBA bindings. The main features of the security layer are:

- *Authentication*—the security layer calls the Artix security service (which maintains a database of user data) to authenticate a user's credentials. If authentication is successful, the Artix security service returns a list of the user's roles and realms.
- *Authorization*—the security layer matches the user's roles and realms against an action-role mapping file to determine whether the user has permission to invoke the relevant WSDL operation.
- *Inserting and extracting SOAP 1.2 security credentials (C++ runtime only)*—the security layer is responsible for inserting and extracting security credentials to and from SOAP 1.2 message headers.

---

**Authentication options**

As shown in [Figure 17 on page 130](#), the SOAP binding supports the following authentication options:

- [WSS UsernameToken](#).
  - [WSS Kerberos](#).
  - [WSS X.509 certificate](#).
  - [CORBA Principal—C++ runtime](#).
  - [HTTP Basic Authentication](#).
  - [SSL/TLS X.509 certificate](#).
- 

**WSS UsernameToken**

The Web service security extension (WSS) UsernameToken is a username/password combination that can be sent in a SOAP header. The specification of WSS UsernameToken is contained in the [WSS UsernameToken Profile 1.0](#) document from [OASIS](#) ([www.oasis-open.org](http://www.oasis-open.org)). Prior to Artix version 4.0.1, the WSS UsernameToken could be set only by programming. From Artix 4.0.1 onward, the WSS UsernameToken can be set either by programming or through configuration. See [“Creating and Sending Credentials” on page 564](#), [“Propagating a Username/Password Token” on page 541](#) and [“principal\\_sponsor:wsse” on page 693](#).

**Note:** *C++ runtime only*—if using a SOAP 1.2 binding, you must also load the Artix security plug-in on the *client side* in order to transmit WSS UsernameTokens. See [“Load the artix\\_security plug-in” on page 380](#) for details.

---

**WSS Kerberos**

The WSS Kerberos specification is used to send a Kerberos security token in a SOAP header. If you use Kerberos, you must also configure the Artix security service to use the Kerberos adapter—see [“Configuring the Kerberos Adapter” on page 301](#).

Currently, the WSS Kerberos token can be set *only* by programming. See [“Creating and Sending Credentials” on page 564](#) and [“Propagating a Kerberos Token” on page 546](#).

**Note:** *C++ runtime only*—if using a SOAP 1.2 binding, you must also load the Artix security plug-in on the *client side* in order to transmit WSS Kerberos tokens. See [“Load the artix\\_security plug-in” on page 380](#) for details.

---

**WSS X.509 certificate**

The WSS specification allows you to send an X.509 certificate in a SOAP header. For the purpose of authentication, Artix takes the username to be the common name from the certificate's subject DN.

For details, see [“WSS X.509 Certificates and Authentication—C++ Runtime” on page 135](#).

**Note:** *C++ runtime only*—if using a SOAP 1.2 binding, you must also load the Artix security plug-in on the *client side* in order to transmit WSS X.509 certificates. See [“Load the artix\\_security plug-in” on page 380](#) for details.

**Note:** *Java runtime*—you can transmit an X.509 certificate in a SOAP header *only* in the context of WSS partial message protection, where you use the certificate to encrypt or sign parts of the SOAP message.

---

**CORBA Principal—C++ runtime**

The CORBA Principal is a legacy feature originally defined in the early versions of the CORBA GIOP specification. To facilitate interoperability with early CORBA implementations, the Artix SOAP binding is also able to propagate CORBA Principals. This feature is available only for SOAP over HTTP and a SOAP header is used to propagate the CORBA Principal.

For details, see [“Principal Propagation—C++ Runtime” on page 485](#).

**Note:** *C++ runtime only*—if using a SOAP 1.2 binding, you must also load the Artix security plug-in on the *client side* in order to transmit CORBA Principals. See [“Load the artix\\_security plug-in” on page 380](#) for details.

---

**HTTP Basic Authentication**

HTTP Basic Authentication is used to propagate username/password credentials in a HTTP header. This kind of authentication is available to any HTTP-compatible binding.

For details, see [“HTTP Basic Authentication—C++ Runtime” on page 114](#).

---

**SSL/TLS X.509 certificate**

You can use an X.509 certificate from the SSL/TLS layer for the purpose of performing authentication and authorization at the Artix security layer. This kind of authentication is available to any HTTP-compatible binding.

For details, see [“X.509 Certificate-Based Authentication—Java Runtime” on page 118](#) and [“X.509 Certificate-Based Authentication—C++ Runtime” on page 123](#).

# WSS X.509 Certificates and Authentication—C++ Runtime

## Overview

This section describes how to enable X.509 certificate authentication for certificates extracted from a WSS SOAP header, based on a simple two-tier client/server scenario. In this scenario, the Artix security service retrieves roles and realms based on the identity of the certificate subject.

**WARNING:** The WSS X.509 certificate is not authenticated by the server, and the security service does *not* verify the identity of the certificate owner. The receiver of the WSS X.509 certificate relies on the sender to perform authentication. This contrasts with the case of X.509 certificates sent over a TLS transport, where the receiver *does* verify the certificate owner's identity.

## Certificate-based authentication scenario

Figure 18 shows an example of a two-tier system, where authentication of the client's WSS X.509 certificate is integrated with the Artix security service.

**Figure 18:** Overview of Certificate-Based Authentication with WSS

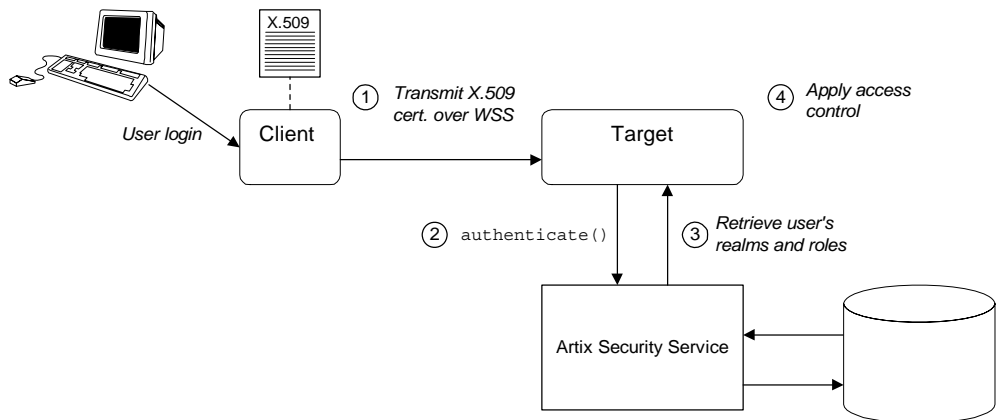

**Scenario description**

The scenario shown in [Figure 18](#) can be described as follows:

Stage	Description
1	When the client opens a connection to the server, the client sends an X.509 certificate in a WSS SOAP header. The server does not check the certificate itself.
2	<p>The server performs security layer authentication by calling <code>authenticate()</code> on the Artix security service, passing username and password arguments as follows:</p> <ul style="list-style-type: none"> <li>• <i>Username</i>—obtained by extracting the common name (CN) from the client certificate's subject DN.</li> <li>• <i>Password</i>—obtained from the value of the <code>plugins:asp:default_password</code> configuration variable in the server's <code>artix.cfg</code> domain configuration.</li> </ul> <p><b>WARNING:</b> This step is <i>not</i> a true authentication step, because the password is cached on the server side. Effectively, this authentication is performed with a dummy password.</p>
3	If the preceding step is successful, the Artix security service returns the user's realms and roles.
4	The ASP security layer controls access to the target's WSDL operations by consulting an <i>action-role mapping file</i> to determine what the user is allowed to do.

**Credentials priority**

When performing authentication, the X.509 certificate credentials have a *lower* priority than that of the other SOAP credential types. For example, if both WSS UsernameToken credentials and X.509 certificate credentials are available, the WSS UsernameToken credentials take priority over the X.509 certificate and are used to perform authentication and authorization at the Artix security layer.

**Programming the client for WSS certificate-based authentication**

On the client side, you need to insert an X.509 certificate into the WSS SOAP header by programming the `bus-security` context (there is currently no configuration option for doing this). For details, see [“Propagating an X.509 Certificate” on page 551](#).



## Configuring the server for WSS certificate-based authentication

On the server side it is necessary to configure the ASP security layer by editing the Artix configuration file, as shown in [Example 30](#).

### Example 30: Configuration for WSS Certificate-Based Authentication

```
# Artix Configuration File
security_artix {
    ...
    demos
    {
        hello_world
        {
            plugins:artix_security:shlib_name =
1         "it_security_plugin";
            binding:artix:server_request_interceptor_list=
2         "principal_context+security";
            binding:client_binding_list = ["OTS+POA_Coloc",
3         "POA_Coloc", "OTS+GIOP+IIOP", "GIOP+IIOP", "GIOP+IIOP_TLS"];
            orb_plugins = ["xmlfile_log_stream", ..., "at_http",
4         "artix_security", "https"];
            plugins:is2_authorization:action_role_mapping =
5         "file://ArtixInstallDir/cxx_java/samples/security/full_security/
6         etc/helloworld_action_role_mapping.xml";
            policies:asp:enable_authorization = "true";
7         plugins:asp:security_level = "REQUEST_LEVEL";
            plugins:asp:default_password = "CertPassword";
            plugins:asp:authentication_cache_size = "5";
            plugins:asp:authentication_cache_timeout = "10";
            ...
        };
        ...
    };
};
```

The preceding extract from the domain configuration can be explained as follows:

1. The Artix server request interceptor list must include the `security` interceptor, which provides part of the functionality for the Artix security layer.
2. The `orb_plugins` list should include the `artix_security` plug-in, which is responsible for enabling authentication and authorization.

3. The action-role mapping file is used to apply access control rules to the authenticated user. The file determines which actions (that is, WSDL operations) can be invoked by an authenticated user, on the basis of the roles assigned to that user.  
See [“Managing Access Control Lists” on page 351](#) for more details.
4. `policies:asp:enable_authorization` variable must be set to `true` to enable authorization.
5. The `plugins:asp:security_level` configuration variable specifies whether the credentials are taken from a request-level header or from a transport-level header. By setting the security level to `REQUEST_LEVEL`, you indicate that the credentials are taken from a SOAP header (for example, WSS X.509 certificate or WSS UsernameToken credentials). In the case of WSS X.509 certificate-based authentication, the username is taken to be the common name (CN) from the client certificate’s subject DN (for an explanation of X.509 certificate terminology, see [“ASN.1 and Distinguished Names” on page 731](#)).
6. When WSS X.509 certificate-based authentication is used, a default password, `CertPassword`, must be supplied on the server side. This password is then used for authenticating with the Artix security service.
7. The next pair of configuration variables configure the ASP caching mechanism. For more details, see [“ASP configuration variables” on page 90](#).

# Security for CORBA Bindings

*Using IONA's modular ART technology, you make a CORBA binding secure by configuring it to load the relevant security plug-ins. This section describes how to load and configure security plug-ins to reach the appropriate level of security for applications with a CORBA binding.*

## In this chapter

This chapter discusses the following topics:

<a href="#">Overview of CORBA Security</a>	<a href="#">page 140</a>
<a href="#">Securing IIOP Communications with SSL/TLS</a>	<a href="#">page 142</a>
<a href="#">Securing Two-Tier CORBA Systems with CSI—C++ Runtime</a>	<a href="#">page 148</a>
<a href="#">Securing Three-Tier CORBA Systems with CSI—C++ Runtime</a>	<a href="#">page 154</a>
<a href="#">X.509 Certificate-Based Authentication for CORBA Bindings—C++ Runtime</a>	<a href="#">page 161</a>

# Overview of CORBA Security

## Overview

There are three layers of security available for CORBA bindings: IIOP over SSL/TLS (IIOP/TLS), which provides secure communication between client and server; CSI, which provides a mechanism for propagating username/password credentials; and the GSP plug-in, which is concerned with higher-level security features such as authentication and authorization.

The following combinations are recommended:

- IIOP/TLS only (*C++ runtime and Java runtime*)—for a pure SSL/TLS security solution.
- IIOP/TLS, CSI, and GSP layers (*C++ runtime*)—for a highly scalable security solution, based on username/password client authentication.

## CORBA applications and the Artix security framework

Figure 19 shows the main features of a secure CORBA application in the context of the Artix security framework.

**Figure 19:** A Secure CORBA Application within the Artix Security Framework

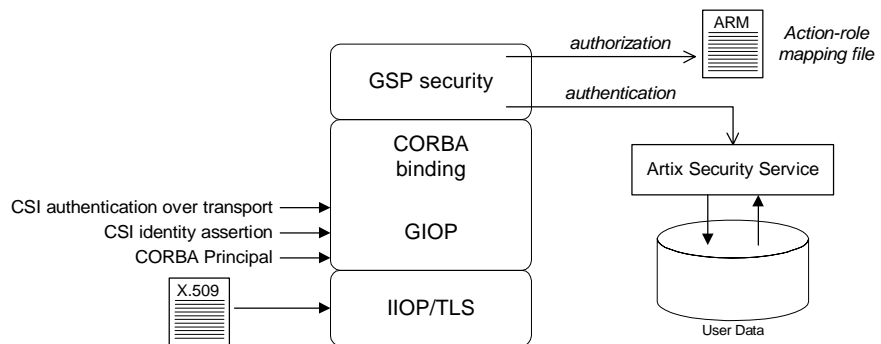

---

**Security plug-ins**

Within the Artix security framework, a CORBA application becomes fully secure by loading the following plug-ins:

- [IIOP/TLS plug-in—C++ runtime and Java runtime](#)
  - [CSlv2 plug-in—C++ runtime](#)
  - [GSP plug-in—C++ runtime](#)
- 

**IIOP/TLS plug-in—C++ runtime and Java runtime**

The IIOP/TLS plug-in, `iiop_tls`, enables a CORBA application to transmit and receive IIOP requests over a secure SSL/TLS connection. This plug-in can be enabled independently of the other two plug-ins.

See [“Securing IIOP Communications with SSL/TLS” on page 142](#) for details on how to enable IIOP/TLS in a CORBA application.

---

**CSlv2 plug-in—C++ runtime**

The CSlv2 plug-in, `csi`, provides a client authentication mechanism for CORBA applications. The authentication mechanism is based on a username and a password. When the CSlv2 plug-in is configured for use with the Artix security framework, the username and password are forwarded to a central Artix security service to be authenticated. This plug-in is needed to support the Artix security framework.

**Note:** The IIOP/TLS plug-in also provides a client authentication mechanism (based on SSL/TLS and X.509 certificates). The SSL/TLS and CSlv2 authentication mechanisms are independent of each other and can be used simultaneously.

---

**GSP plug-in—C++ runtime**

The GSP plug-in, `gsp`, provides authorization by checking a user's roles against the permissions stored in an action-role mapping file. This plug-in is needed to support the Artix security framework.

---

# Securing IIOP Communications with SSL/TLS

---

## Overview

This section describes how to configure a CORBA binding to use SSL/TLS security. In this section, it is assumed that your initial configuration comes from a secure location domain.

**WARNING:** The default certificates used in the CORBA configuration samples are for demonstration purposes only and are completely insecure. You must generate your own custom certificates for use in your own CORBA applications.

---

## Java runtime configuration

If your application is written using the JAX-WS or Javascript programming interfaces, you must use the *Artix Java runtime*. The CORBA binding provided by the Java runtime is *not* configured by an XML configuration file, however. You must configure the CORBA binding using an old-style Artix configuration file (ending with a `.cfg` suffix).

Before you can configure a CORBA binding in the Java runtime, you must associate your program with an Artix configuration file—see [“Configuring the Java Runtime CORBA Binding” on page 765](#) for details.

---

## Sample client configuration

For example, consider the configuration for a secure SSL/TLS client with no certificate.

[Example 31](#) shows how to configure such a sample client.

### Example 31: Sample SSL/TLS Client Configuration

```
# Artix Configuration File
...
# General configuration at root scope.
...
my_secure_apps {
  # Common SSL/TLS configuration settings.
1  orb_plugins = ["local_log_stream", "iiop_profile", "giop",
  "iiop_tls"];
```

**Example 31:** Sample SSL/TLS Client Configuration

```

2 binding:client_binding_list = ["GIOP+EGMIOP",
"OTS+TLS_Coloc+POA_Coloc", "TLS_Coloc+POA_Coloc",
"OTS+POA_Coloc", "POA_Coloc", "GIOP+SHMIOP",
"CSI+OTS+GIOP+IIOP_TLS", "OTS+GIOP+IIOP_TLS",
"CSI+GIOP+IIOP_TLS", "GIOP+IIOP_TLS", "CSI+OTS+GIOP+IIOP",
"OTS+GIOP+IIOP", "CSI+GIOP+IIOP", "GIOP+IIOP"];

3 policies:trusted_ca_list_policy =
"ArtixInstallDir\cxx_java\samples\certificates\tls\x509\trust
ed_ca_lists\ca_list1.pem";

4 policies:mechanism_policy:protocol_version = "SSL_V3";
policies:mechanism_policy:ciphersuites =
["RSA_WITH_RC4_128_SHA", "RSA_WITH_RC4_128_MD5"];

5 event_log:filters = ["IT_ATLI_TLS=*", "IT_IIOP=*",
"IT_IIOP_TLS=*", "IT_TLS=*"];
...
my_client {
6     # Specific SSL/TLS client configuration settings
principal_sponsor:use_principal_sponsor = "false";

7     policies:client_secure_invocation_policy:requires =
["Confidentiality", "Integrity", "DetectReplay",
"DetectMisordering", "EstablishTrustInTarget"];
policies:client_secure_invocation_policy:supports =
["Confidentiality", "Integrity", "DetectReplay",
"DetectMisordering", "EstablishTrustInTarget"];
};
};
...

```

The preceding client configuration can be described as follows:

1. Make sure that the `orb_plugins` variable in this configuration scope includes the `iiop_tls` plug-in.

**Note:** For fully secure applications, you should *exclude* the `iiop` plug-in (insecure IIOp) from the ORB plug-ins list. This renders the application incapable of making insecure IIOp connections.

For semi-secure applications, however, you should *include* the `iiop` plug-in before the `iiop_tls` plug-in in the ORB plug-ins list.

If you plan to use the full Artix Security Framework, you should include the `gsp` plug-in in the ORB plug-ins list as well—see [“Securing Two-Tier CORBA Systems with CSI—C++ Runtime” on page 148](#).

2. Make sure that the `binding:client_binding_list` variable includes bindings with the `IIOP_TLS` interceptor. You can use the value of the `binding:client_binding_list` shown here.
3. An SSL/TLS application needs a list of trusted CA certificates, which it uses to determine whether or not to trust certificates received from other SSL/TLS applications. You must, therefore, edit the `policies:trusted_ca_list_policy` variable to point at a list of trusted certificate authority (CA) certificates. See [“Specifying Trusted CA Certificates” on page 206](#).

**Note:** If using Schannel as the underlying SSL/TLS toolkit (Windows only), the `policies:trusted_ca_list_policy` variable is ignored. Within Schannel, the trusted root CA certificates are obtained from the Windows certificate store.

4. The SSL/TLS mechanism policy specifies the default security protocol version and the available cipher suites—see [“Specifying Cipher Suites” on page 257](#).
5. This line enables console logging for security-related events, which is useful for debugging and testing. Because there is a performance penalty associated with this option, you might want to comment out or delete this line in a production system.
6. The SSL/TLS principal sponsor is a mechanism that can be used to specify an application’s own X.509 certificate. Because this client configuration does not use a certificate, the principal sponsor is disabled by setting `principal_sponsor:use_principal_sponsor` to `false`.
7. The following two lines set the *required* options and the *supported* options for the client secure invocation policy. In this example, the policy is set as follows:
  - ◆ Required options—the options shown here ensure that the client can open only secure SSL/TLS connections.



- ◆ Supported options—the options shown include all of the association options, except for the `EstablishTrustInClient` option. The client cannot support `EstablishTrustInClient`, because it has no X.509 certificate.

## Sample server configuration

Generally speaking, it is rarely necessary to configure such a thing as a *pure server* (that is, a server that never makes any requests of its own). Most real servers are applications that act in both a server role and a client role.

**Note:** If using the Java runtime, you must first associate the server with a configuration file—see [“Configuring the Java Runtime CORBA Binding” on page 765](#) for details.

[Example 32](#) shows how to configure a sample server that acts both as a secure server and as a secure client.

### Example 32: Sample SSL/TLS Server Configuration

```
# Artix Configuration File
...
# General configuration at root scope.
...
1 my_secure_apps {
    # Common SSL/TLS configuration settings.
    ...
    2 my_server {
        # Specific SSL/TLS server configuration settings
        policies:target_secure_invocation_policy:requires =
["Confidentiality", "Integrity", "DetectReplay",
"DetectMisordering"];
        policies:target_secure_invocation_policy:supports =
["EstablishTrustInClient", "Confidentiality", "Integrity",
"DetectReplay", "DetectMisordering",
"EstablishTrustInTarget"];
    3
        principal_sponsor:use_principal_sponsor = "true";
    4
        principal_sponsor:auth_method_id = "pkcs12_file";
    5
        principal_sponsor:auth_method_data =
["filename=CertsDir\server_cert.p12"];
    }
```

**Example 32:** *Sample SSL/TLS Server Configuration*

```

6      # Specific SSL/TLS client configuration settings
      policies:client_secure_invocation_policy:requires =
["Confidentiality", "Integrity", "DetectReplay",
"DetectMisordering", "EstablishTrustInTarget"];
      policies:client_secure_invocation_policy:supports =
["Confidentiality", "Integrity", "DetectReplay",
"DetectMisordering", "EstablishTrustInClient",
"EstablishTrustInTarget"];
    };
    ...

```

The preceding server configuration can be described as follows:

1. You can use the same common SSL/TLS settings here as described in the preceding [“Sample client configuration” on page 142](#)
2. The following two lines set the *required* options and the *supported* options for the target secure invocation policy. In this example, the policy is set as follows:
  - ◆ Required options—the options shown here ensure that the server accepts only secure SSL/TLS connection attempts.
  - ◆ Supported options—all of the target association options are supported.
3. A server must always be associated with an X.509 certificate. Hence, this line enables the SSL/TLS principal sponsor, which specifies a certificate for the application.
4. This line specifies that the X.509 certificate is contained in a PKCS#12 file. For alternative methods, see [“Specifying an Application’s Own Certificate” on page 216](#).
5. Replace the X.509 certificate, by editing the `filename` option in the `principal_sponsor:auth_method_data` configuration variable to point at a custom X.509 certificate. The `filename` value should be initialized with the location of a certificate file in PKCS#12 format—see [“Specifying an Application’s Own Certificate” on page 216](#) for more details.

For details of how to specify the certificate’s pass phrase, see [“Deploying Own Certificate for HTTPS—C++ Runtime” on page 219](#).

6. The following two lines set the *required* options and the *supported* options for the client secure invocation policy. In this example, the policy is set as follows:
  - ◆ Required options—the options shown here ensure that the application can open only secure SSL/TLS connections to other servers.
  - ◆ Supported options—all of the client association options are supported. In particular, the `EstablishTrustInClient` option is supported when the application is in a client role, because the application has an X.509 certificate.

---

### Mixed security configurations

Most realistic secure server configurations are mixed in the sense that they include both server settings (for the server role), and client settings (for the client role). When combining server and client security settings for an application, you must ensure that the settings are consistent with each other.

For example, consider the case where the server settings are *secure* and the client settings are *insecure*. To configure this case, set up the server role as described in [“Sample server configuration” on page 145](#). Then configure the client role by adding (or modifying) the following lines to the `my_secure_apps.my_server` configuration scope:

```
orb_plugins = ["local_log_stream", "iiop_profile", "giop",
              "iiop", "iiop_tls"];
policies:client_secure_invocation_policy:requires =
  ["NoProtection"];
policies:client_secure_invocation_policy:supports =
  ["NoProtection"];
```

The first line sets the ORB plug-ins list to make sure that the `iiop` plug-in (enabling insecure IIOP) is included. The `NoProtection` association option, which appears in the required and supported client secure invocation policy, effectively disables security for the client role.

---

### Customizing SSL/TLS security policies

You can, optionally, customize the SSL/TLS security policies in various ways. For details, see the following references:

- [“Configuring Secure Associations” on page 241](#).
- [“Configuring HTTPS and IIOP/TLS Authentication” on page 195](#).

# Securing Two-Tier CORBA Systems with CSI—C++ Runtime

## Overview

This section describes how to secure a two-tier CORBA system using the OMG's Common Secure Interoperability specification version 2.0 (CSIv2). The client supplies username/password authentication data which is transmitted as CSI credentials and then authenticated on the server side. The following configurations are described in detail:

- [Client configuration](#).
- [Target configuration](#).

## Two-tier CORBA system

Figure 20 shows a basic two-tier CORBA system using CSI credentials, featuring a client and a target server.

**Figure 20:** *Two-Tier CORBA System Using CSI Credentials*

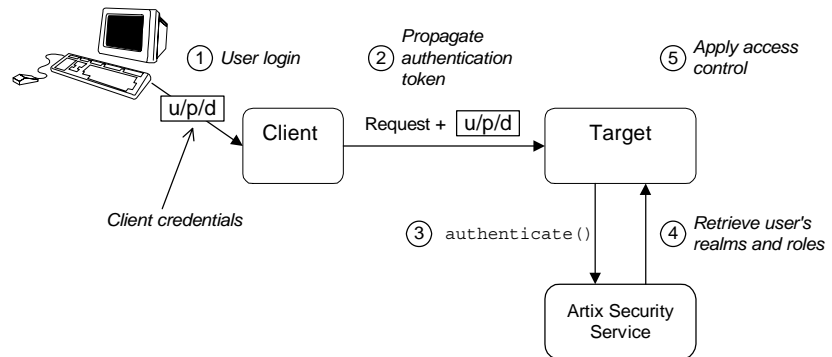

**Scenario description**

The scenario shown in [Figure 20](#) can be described as follows:

Stage	Description
1	The user enters a username, password, and domain name (u/p/d) on the client side. <b>Note:</b> The domain name must match the value of the <code>policies:csi:auth_over_transport:server_domain_name</code> configuration variable set on the server side.
2	When the client makes a remote invocation on the server, the CSI username/password/domain authentication data is transmitted to the target along with the invocation request.
3	The server authenticates the received username and password by calling out to the external Artix security service.
4	If authentication is successful, the Artix security service returns the user's realms and roles.
5	The GSP security layer controls access to the target's IDL interfaces by consulting an <i>action-role mapping file</i> to determine what the user is allowed to do.

**Client configuration**

The CORBA client from [Example 20 on page 148](#) can be configured as shown in [Example 33](#).

**Example 33:** *Configuration of a CORBA client Using CSI Credentials*

```
# Artix Configuration File
...
# General configuration at root scope.
...
my_secure_apps {
1   # Common SSL/TLS configuration settings.
    ...
    # Common Artix security framework configuration settings.
2   orb_plugins = ["local_log_stream", "iiop_profile", "giop",
                  "iiop_tls", "gsp"];
```

**Example 33:** Configuration of a CORBA client Using CSI Credentials

```

3   binding:client_binding_list = ["GIOP+EGMIOP",
   "OTS+TLS_Coloc+POA_Coloc", "TLS_Coloc+POA_Coloc",
   "OTS+POA_Coloc", "POA_Coloc", "GIOP+SHMIOP",
   "CSI+OTS+GIOP+IIOP_TLS", "OTS+GIOP+IIOP_TLS",
   "CSI+GIOP+IIOP_TLS", "GIOP+IIOP_TLS", "CSI+OTS+GIOP+IIOP",
   "OTS+GIOP+IIOP", "CSI+GIOP+IIOP", "GIOP+IIOP"];
4   binding:server_binding_list = ["CSI+GSP+OTS", "CSI+GSP",
   "CSI+OTS", "CSI"];
   ...
5   my_client {
   # Specific SSL/TLS configuration settings.
   ...
6   # Specific Artix security framework settings.
   policies:csi:auth_over_transport:client_supports =
["EstablishTrustInClient"];
7
   principal_sponsor:csi:use_principal_sponsor = "true";
   principal_sponsor:csi:auth_method_id = "GSSUPMech";
   principal_sponsor:csi:auth_method_data = [];
   };
};
...

```

The preceding client configuration can be explained as follows:

1. The SSL/TLS configuration variables common to all of your applications can be placed here—see [“Securing IIOp Communications with SSL/TLS” on page 142](#) for details of the SSL/TLS configuration.
2. Make sure that the `orb_plugins` variable in this configuration scope includes both the `iiop_tls` and the `gsp` plug-ins in the order shown.
3. Make sure that the `binding:client_binding_list` variable includes bindings with the `CSI` interceptor. You can use the value of the `binding:client_binding_list` shown here.
4. Make sure that the `binding:server_binding_list` variable includes bindings with both the `CSI` and `GSP` interceptors. You can use the value of the `binding:server_binding_list` shown here.
5. The SSL/TLS configuration variables specific to the CORBA client can be placed here—see [“Securing IIOp Communications with SSL/TLS” on page 142](#).

6. This configuration setting specifies that the client supports sending username/password authentication data to a server.
7. The next three lines specify that the client uses the CSI principal sponsor to obtain the user's authentication data. With the configuration as shown, the user would be prompted to enter the username and password when the client application starts up.

**Note:** If using the Java runtime, you must first associate the client with a configuration file—see [“Configuring the Java Runtime CORBA Binding” on page 765](#) for details.

## Target configuration

The CORBA target server from [Figure 20 on page 148](#) can be configured as shown in [Example 34](#).

### Example 34: Configuration of a Second-Tier Target Server in the Artix Security Framework

```
# Artix Configuration File
...
# General configuration at root scope.
...
my_secure_apps {
    # Common SSL/TLS configuration settings.
    ...
    # Common Artix security framework configuration settings.
    orb_plugins = [ ..., "iiop_tls", "gsp", ... ];
    binding:client_binding_list = [ ... ];
    binding:server_binding_list = [ ... ];
    ...
    my_two_tier_target {
1        # Specific SSL/TLS configuration settings.
        ...
2        # Specific Artix security framework settings.
        policies:csi:auth_over_transport:target_supports =
3        ["EstablishTrustInClient"];
        policies:csi:auth_over_transport:target_requires =
4        ["EstablishTrustInClient"];
        policies:csi:auth_over_transport:server_domain_name =
        "CSIDomainName";
5        plugins:gsp:authorization_realm = "AuthzRealm";
    }
}
```

**Example 34:** Configuration of a Second-Tier Target Server in the Artix Security Framework

```

6     plugins:is2_authorization:action_role_mapping =
      "ActionRoleURL";
7
      # Artix security framework client configuration settings.
      policies:csi:auth_over_transport:client_supports =
        ["EstablishTrustInClient"];

        principal_sponsor:csi:use_principal_sponsor = "true";
        principal_sponsor:csi:auth_method_id = "GSSUPMech";
        principal_sponsor:csi:auth_method_data = [];
      };
};

```

The preceding target server configuration can be explained as follows:

1. The SSL/TLS configuration variables specific to the CORBA target server can be placed here—see [“Securing IIOP Communications with SSL/TLS” on page 142](#).
2. This configuration setting specifies that the target server *supports* receiving username/password authentication data from the client.
3. This configuration setting specifies that the target server *requires* the client to send username/password authentication data.
4. The `server_domain_name` configuration variable sets the server’s CSIV2 authentication domain name, `CSIDomainName`. The domain name embedded in a received CSIV2 credential must match the value of the `server_domain_name` variable on the server side.
5. This configuration setting specifies the Artix authorization realm, `AuthzRealm`, to which this server belongs. For more details about Artix authorization realms, see [“Artix Authorization Realms” on page 339](#).
6. The `action_role_mapping` configuration variable specifies the location of an action-role mapping that controls access to the IDL interfaces implemented by the server. The file location is specified in an URL format, for example:
 

```
file:///security_admin/action_role_mapping.xml (UNIX) or
file:///c:/security_admin/action_role_mapping.xml (Windows).
```

 For more details about the action-role mapping file, see [“ACL File Format” on page 353](#).



7. You should also set secure client configuration variables in the server configuration scope, because a secure server application usually behaves as a secure client of the core CORBA services. For example, almost all CORBA servers need to contact both the locator service and the CORBA naming service.

**Note:** If using the Java runtime, you must first associate the server with a configuration file—see [“Configuring the Java Runtime CORBA Binding” on page 765](#) for details.

---

### Related administration tasks

After securing your CORBA applications with the Artix security framework, you might need to perform related administration tasks, for example:

- See [“Managing Users, Roles and Domains” on page 335](#).
- See [“ACL File Format” on page 353](#).

# Securing Three-Tier CORBA Systems with CSI—C++ Runtime

## Overview

This section describes how to secure a three-tier CORBA system using CSIv2. In this scenario there is a client, an intermediate server, and a target server. The intermediate server is configured to propagate the client identity when it invokes on the target server in the third tier. The following configurations are described in detail:

- [Intermediate configuration.](#)
- [Target configuration.](#)

## Three-tier CORBA system

Figure 21 shows a basic three-tier CORBA system using CSIv2, featuring a client, an intermediate server and a target server.

**Figure 21:** *Three-Tier CORBA System Using CSIv2*

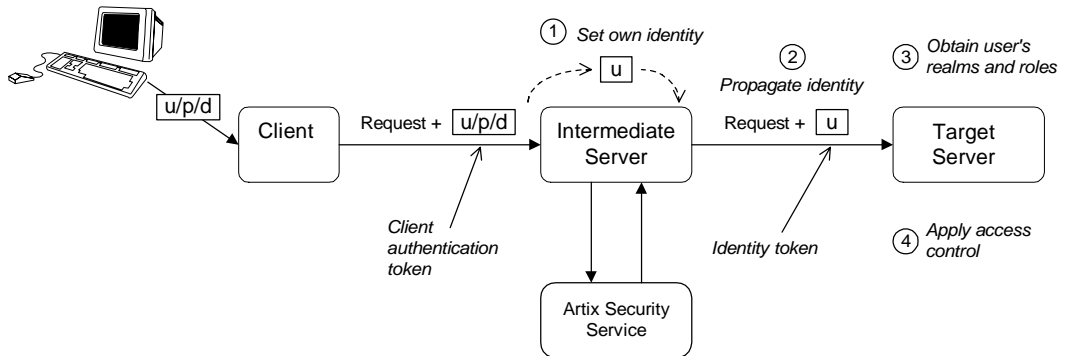

**Scenario description**

The second stage of the scenario shown in [Figure 21](#) (intermediate server invokes an operation on the target server) can be described as follows:

Stage	Description
1	The intermediate server sets its own identity by extracting the user identity from the received username/password CSI credentials. Hence, the intermediate server assumes the same identity as the client.
2	When the intermediate server makes a remote invocation on the target server, CSI identity assertion is used to transmit the user identity data to the target.
3	The target server then obtains the user's realms and roles.
4	The GSP security layer controls access to the target's IDL interfaces by consulting an <i>action-role mapping file</i> to determine what the user is allowed to do.

**Client configuration**

The client configuration for the three-tier scenario is identical to that of the two-tier scenario, as shown in [“Client configuration” on page 149](#).

**Intermediate configuration**

The CORBA intermediate server from [Figure 21 on page 154](#) can be configured as shown in [Example 35](#).

**Example 35:** *Configuration of a Second-Tier Intermediate Server in the Artix Security Framework*

```
# Artix Configuration File
...
# General configuration at root scope.
...
my_secure_apps {
    # Common SSL/TLS configuration settings.
    ...
    # Common Artix security framework configuration settings.
    orb_plugins = [ ..., "iiop_tls", "gsp", ... ];
    binding:client_binding_list = [ ... ];
    binding:server_binding_list = [ ... ];
    ...
}
```

**Example 35:** Configuration of a Second-Tier Intermediate Server in the Artix Security Framework

```

1     my_three_tier_intermediate {
        # Specific SSL/TLS configuration settings.
        ...
2     # Specific Artix security framework settings.
        policies:csi:attribute_service:client_supports =
["IdentityAssertion"];

3     policies:csi:auth_over_transport:target_supports =
["EstablishTrustInClient"];
4     policies:csi:auth_over_transport:target_requires =
["EstablishTrustInClient"];
5     policies:csi:auth_over_transport:server_domain_name =
"CSIDomainName";

6     plugins:gsp:authorization_realm = "AuthzRealm";
7     plugins:is2_authorization:action_role_mapping =
"ActionRoleURL";

8     # Artix security framework client configuration settings.
        policies:csi:auth_over_transport:client_supports =
["EstablishTrustInClient"];

        principal_sponsor:csi:use_principal_sponsor = "true";
        principal_sponsor:csi:auth_method_id = "GSSUPMech";
        principal_sponsor:csi:auth_method_data = [];
    };
};

```

The preceding intermediate server configuration can be explained as follows:

1. The SSL/TLS configuration variables specific to the CORBA intermediate server can be placed here—see [“Securing IIOP Communications with SSL/TLS” on page 142](#).
2. This configuration setting specifies that the intermediate server is capable of propagating the identity it receives from a client. In other words, the server is able to assume the identity of the client when invoking operations on third-tier servers.
3. This configuration setting specifies that the intermediate server *supports* receiving username/password authentication data from the client.

4. This configuration setting specifies that the intermediate server *requires* the client to send username/password authentication data.
5. The `server_domain_name` configuration variable sets the server's CSIv2 authentication domain name, *CSIDomainName*. The domain name embedded in a received CSIv2 credential must match the value of the `server_domain_name` variable on the server side.
6. This configuration setting specifies the Artix authorization realm, *AuthzRealm*, to which this server belongs. For more details about Artix authorization realms, see [“Artix Authorization Realms” on page 339](#).
7. This configuration setting specifies the location of an action-role mapping that controls access to the IDL interfaces implemented by the server. The file location is specified in an URL format, for example:  
`file:///security_admin/action_role_mapping.xml` (UNIX) or  
`file:///c:/security_admin/action_role_mapping.xml` (Windows).  
 For more details about the action-role mapping file, see [“ACL File Format” on page 353](#).
8. You should also set Artix security framework client configuration variables in the intermediate server configuration scope, because a secure server application usually behaves as a secure client of the core CORBA services. For example, almost all CORBA servers need to contact both the locator service and the CORBA naming service.

**Note:** If using the Java runtime, you must first associate the intermediate server with a configuration file—see [“Configuring the Java Runtime CORBA Binding” on page 765](#) for details.

## Target configuration

The CORBA target server from [Figure 21 on page 154](#) can be configured as shown in [Example 36](#).

### Example 36: Configuration of a Third-Tier Target Server Using CSI

```
# Artix Configuration File
...
# General configuration at root scope.
...
my_secure_apps {
    # Common SSL/TLS configuration settings.
    ...
}
```

**Example 36:** Configuration of a Third-Tier Target Server Using CSI

```

# Common Artix security framework configuration settings.
orb_plugins = [ ..., "iiop_tls", "gsp", ... ];
binding:client_binding_list = [ ... ];
binding:server_binding_list = [ ... ];
...
my_three_tier_target {
    # Specific SSL/TLS configuration settings.
    1     ...
    2     policies:iiop_tls:target_secure_invocation_policy:requires
= ["Confidentiality", "DetectMisordering", "DetectReplay",
"Integrity", "EstablishTrustInClient"];
    3     policies:iiop_tls:certificate_constraints_policy =
["ConstraintString1, ConstraintString2, ...];

    # Specific Artix security framework settings.
    4     policies:csi:attribute_service:target_supports =
["IdentityAssertion"];

    5     plugins:gsp:authorization_realm = "AuthzRealm";
    6     plugins:is2_authorization:action_role_mapping =
"ActionRoleURL";

    7     # Artix security framework client configuration settings.
    policies:csi:auth_over_transport:client_supports =
["EstablishTrustInClient"];

    principal_sponsor:csi:use_principal_sponsor = "true";
    principal_sponsor:csi:auth_method_id = "GSSUPMech";
    principal_sponsor:csi:auth_method_data = [];
};
};

```

The preceding target server configuration can be explained as follows:

1. The SSL/TLS configuration variables specific to the CORBA target server can be placed here—see [“Securing IIOP Communications with SSL/TLS” on page 142](#).
2. It is recommended that the target server require its *clients* to authenticate themselves using an X.509 certificate. For example, the intermediate server (acting as a client of the target) would then be required to send an X.509 certificate to the target during the SSL/TLS handshake.

You can specify this option by including the `EstablishTrustInClient` association option in the target secure invocation policy, as shown here (thereby overriding the policy value set in the outer configuration scope).

3. In addition to the preceding step, it is also advisable to restrict access to the target server by setting a certificate constraints policy, which allows access only to those clients whose X.509 certificates match one of the specified constraints—see [“Applying Constraints to Certificates—C++ Runtime” on page 230](#).

**Note:** The motivation for limiting access to the target server is that clients of the target server obtain a special type of privilege: propagated identities are granted access to the target server without the target server performing authentication on the propagated identities. Hence, the target server trusts the intermediate server to do the authentication on its behalf.

4. This configuration setting specifies that the target server supports receiving propagated user identities from the client.
5. This configuration setting specifies the Artix authorization realm, `AuthzRealm`, to which this server belongs. For more details about Artix authorization realms, see [“Artix Authorization Realms” on page 339](#).
6. This configuration setting specifies the location of an action-role mapping that controls access to the IDL interfaces implemented by the server. The file location is specified in an URL format, for example: `file:///security_admin/action_role_mapping.xml`.  
For more details about the action-role mapping file, see [“ACL File Format” on page 353](#).
7. You should also set secure client configuration variables in the target server configuration scope, because a secure server application usually behaves as a secure client of the core CORBA services. For example, almost all CORBA servers need to contact both the locator service and the CORBA naming service.

**Note:** If using the Java runtime, you must first associate the target server with a configuration file—see [“Configuring the Java Runtime CORBA Binding” on page 765](#) for details.

---

**Related administration tasks**

After securing your CORBA applications with the Artix security framework, you might need to perform related administration tasks, for example:

- See [“Managing Users, Roles and Domains” on page 335](#).
- See [“ACL File Format” on page 353](#).



---

# X.509 Certificate-Based Authentication for CORBA Bindings—C++ Runtime

---

## Overview

This section describes how to enable X.509 certificate authentication for CORBA bindings, based on a simple two-tier client/server scenario. In this scenario, the Artix security service authenticates the client's certificate and retrieves roles and realms based on the identity of the certificate subject. When certificate-based authentication is enabled, the X.509 certificate is effectively authenticated twice, as follows:

- *SSL/TLS-level authentication*—this authentication step occurs during the SSL/TLS handshake and is governed by Artix configuration settings and programmable SSL/TLS policies.
- *GSP security-level authentication and authorization*—this authentication step occurs after the SSL/TLS handshake and is performed by the Artix security service working in tandem with the `gsp` plug-in.

**Certificate-based authentication scenario**

Figure 22 shows an example of a two-tier system, where authentication of the client's X.509 certificate is integrated with the Artix security service.

**Figure 22:** Overview of Certificate-Based Authentication

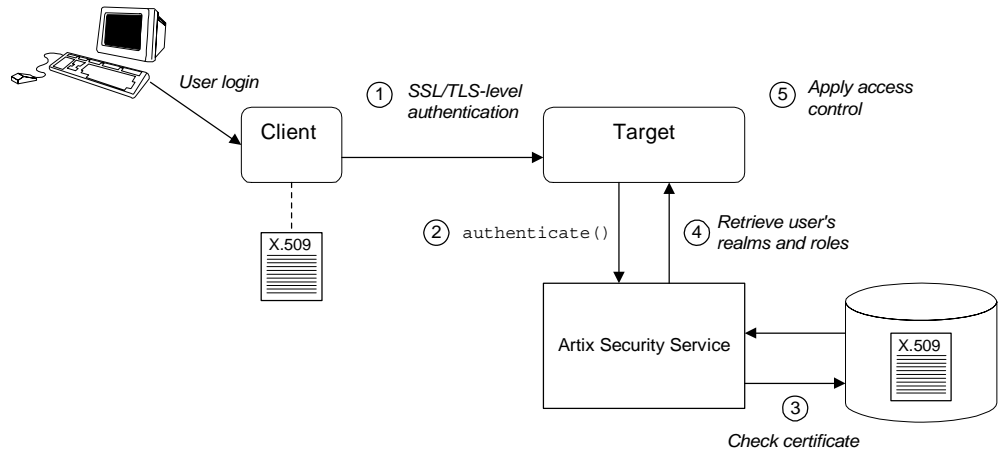

**Scenario description**

The scenario shown in Figure 22 can be described as follows:

Stage	Description
1	When the client opens a connection to the server, the client sends its X.509 certificate as part of the SSL/TLS handshake. The server then performs SSL/TLS-level authentication, checking the certificate as follows: <ul style="list-style-type: none"> <li>• The certificate is checked against the server's <i>trusted CA list</i> to ensure that it is signed by a trusted certification authority.</li> <li>• If a certificate constraints policy is set, the certificate is checked to make sure it satisfies the specified constraints.</li> <li>• If a certificate validator policy is set (by programming), the certificate is also checked by this policy.</li> </ul>

Stage	Description
2	The server then performs security layer authentication by calling <code>authenticate()</code> on the Artix security service, passing the client's X.509 certificate as the argument.
3	The Artix security service authenticates the client's X.509 certificate by checking it against a cached copy of the certificate. The type of checking performed depends on the particular <i>third-party enterprise security service</i> that is plugged into the Artix security service.
4	If authentication is successful, the Artix security service returns the user's realms and roles.
5	The security layer controls access to the target's IDL interfaces by consulting an <i>action-role mapping file</i> to determine what the user is allowed to do.

## Client configuration

[Example 37](#) shows a sample client configuration that you can use for the security-level certificate-based authentication scenario ([Figure 22 on page 162](#)).

### Example 37: Client Configuration for Security-Level Certificate-Based Authentication

```
# Artix Configuration File
corba_cert_auth
{
    orb_plugins = ["local_log_stream", "iiop_profile", "giop",
                 "iiop_tls", "gsp"];

    event_log:filters = ["IT_GSP=*", "IT_CSI=*", "IT_TLS=*",
                       "IT_IIOP_TLS=*", "IT_ATLI2_TLS=*"];

    binding:client_binding_list = ["GIOP+EGMIOP",
                                   "OTS+POA_Coloc", "POA_Coloc", "OTS+TLS_Coloc+POA_Coloc",
                                   "TLS_Coloc+POA_Coloc", "GIOP+SHMIOP", "CSI+OTS+GIOP+IIOP",
                                   "CSI+GIOP+IIOP", "CSI+OTS+GIOP+IIOP_TLS",
                                   "CSI+GIOP+IIOP_TLS", "GIOP+IIOP", "GIOP+IIOP_TLS"];
}
```

**Example 37:** *Client Configuration for Security-Level Certificate-Based Authentication*

```

client_x509
{
    policies:iiop_tls:client_secure_invocation_policy:supports =
    ["Integrity", "Confidentiality", "DetectReplay",
    "DetectMisordering", "EstablishTrustInTarget",
    "EstablishTrustInClient"];

    policies:iiop_tls:client_secure_invocation_policy:requires =
    ["Integrity", "Confidentiality", "DetectReplay",
    "DetectMisordering"];

    principal_sponsor:iiop_tls:use_principal_sponsor =
    "true";
    principal_sponsor:iiop_tls:auth_method_id =
    "pkcs12_file";
    principal_sponsor:iiop_tls:auth_method_data =
    ["filename=W:\certs\bob.p12",
    "password_file=W:\certs\bob_password.txt"];
    };
};

```

The preceding client configuration is a typical SSL/TLS configuration. The only noteworthy feature is that the client must have an associated X.509 certificate. Hence, the `principal_sponsor` settings are initialized with the location of an X.509 certificate (provided in the form of a PKCS#12 file).

For a discussion of these client SSL/TLS settings, see [“Sample client configuration” on page 142](#) and [“Specifying an Application’s Own Certificate” on page 216](#).

**Note:** If using the Java runtime, you must first associate the client with a configuration file—see [“Configuring the Java Runtime CORBA Binding” on page 765](#) for details.

**Target configuration**

[Example 38](#) shows a sample server configuration that you can use for the security-level certificate-based authentication scenario ([Figure 22 on page 162](#)).

**Example 38:** *Server Configuration for Security-Level Certificate-Based Authentication*

```
# Artix Configuration File
corba_cert_auth
{
    orb_plugins = ["local_log_stream", "iiop_profile", "giop",
"iiop_tls", "gsp"];

    event_log:filters = ["IT_GSP=*", "IT_CSI=*", "IT_TLS=*",
"IT_IIOP_TLS=*", "IT_ATLI2_TLS=*"];

    binding:client_binding_list = ["GIOP+EGMIOP",
"OTS+POA_Coloc", "POA_Coloc", "OTS+TLS_Coloc+POA_Coloc",
"TLS_Coloc+POA_Coloc", "GIOP+SHMIOP", "CSI+OTS+GIOP+IIOP",
"CSI+GIOP+IIOP", "CSI+OTS+GIOP+IIOP_TLS",
"CSI+GIOP+IIOP_TLS", "GIOP+IIOP", "GIOP+IIOP_TLS"];

    server
    {
        principal_sponsor:iiop_tls:use_principal_sponsor =
"true";
        principal_sponsor:iiop_tls:auth_method_id =
"pkcs12_file";
1        principal_sponsor:iiop_tls:auth_method_data =
["filename=CertDir\target_cert.p12",
"password_file=CertDir\target_cert_password.txt"];

        binding:server_binding_list = ["CSI+GSP", "CSI",
"GSP"];

2        plugins:is2_authorization:action_role_mapping =
"file:///PathToARMFile";

        auth_x509
        {
3        plugins:gsp:enable_security_service_cert_authentication =
"true";
```

**Example 38:** *Server Configuration for Security-Level Certificate-Based Authentication*

```

4 policies:iiop_tls:target_secure_invocation_policy:supports =
  ["Integrity", "Confidentiality", "DetectReplay",
   "DetectMisordering", "EstablishTrustInTarget",
   "EstablishTrustInClient"];

  policies:iiop_tls:target_secure_invocation_policy:requires =
    ["Integrity", "Confidentiality", "DetectReplay",
     "DetectMisordering", "EstablishTrustInClient"];
    };
  };
};

```

The preceding server configuration can be explained as follows:

1. As is normal for an SSL/TLS server, you must provide the server with its own certificate, `target_cert.p12`. The simplest way to do this is to specify the location of a PKCS#12 file using the principal sponsor.
2. This configuration setting specifies the location of an action-role mapping file, which controls access to the server's interfaces and operations. See [“ACL File Format” on page 353](#) for more details.
3. The `plugins:gsp:enable_security_service_cert_authentication` variable is the key to enabling security-level certificate-based authentication. By setting this variable to `true`, you cause the server to perform certificate authentication in the GSP security layer.
4. The IIOP/TLS target secure invocation policy must require `EstablishTrustInClient`. Evidently, if the client does not provide a certificate during the SSL/TLS handshake, there will be no certificate available to perform the security layer authentication.

**Note:** If using the Java runtime, you must first associate the target server with a configuration file—see [“Configuring the Java Runtime CORBA Binding” on page 765](#) for details.

**Related administration tasks**

When using X.509 certificate-based authentication for CORBA bindings, it is necessary to add the appropriate user data to your *enterprise security system* (which is integrated with the Artix security service through an iSF adapter), as follows:

- File adapter—see [“Certificate-based authentication for the file adapter” on page 346](#).
- LDAP adapter—see [“Certificate-based authentication for the LDAP adapter” on page 349](#).





# Part II

## TLS Security Layer

---

### In this part

This part contains the following chapters:

<a href="#">Managing Certificates</a>	page 171
<a href="#">Configuring HTTPS and IIOP/TLS Authentication</a>	page 195
<a href="#">Configuring HTTPS Cipher Suites—Java Runtime</a>	page 233
<a href="#">Configuring Secure Associations</a>	page 241



# Managing Certificates

*TLS authentication uses X.509 certificates—a common, secure and reliable method of authenticating your application objects. This chapter explains how you can create X.509 certificates that identify your Artix applications.*

---

**In this chapter**

This chapter contains the following sections:

<a href="#">What are X.509 Certificates?</a>	page 172
<a href="#">Certification Authorities</a>	page 174
<a href="#">Certificate Chaining</a>	page 177
<a href="#">PKCS#12 Files</a>	page 179
<a href="#">Creating Your Own Certificates</a>	page 181
<a href="#">Generating a Certificate Revocation List</a>	page 191

---

# What are X.509 Certificates?

---

## Role of certificates

An X.509 certificate binds a name to a public key value. The role of the certificate is to associate a public key with the identity contained in the X.509 certificate.

---

## Integrity of the public key

Authentication of a secure application depends on the integrity of the public key value in the application's certificate. If an impostor replaced the public key with its own public key, it could impersonate the true application and gain access to secure data.

To prevent this form of attack, all certificates must be signed by a *certification authority (CA)*. A CA is a trusted node that confirms the integrity of the public key value in a certificate.

---

## Digital signatures

A CA signs a certificate by adding its *digital signature* to the certificate. A digital signature is a message encoded with the CA's private key. The CA's public key is made available to applications by distributing a certificate for the CA. Applications verify that certificates are validly signed by decoding the CA's digital signature with the CA's public key.

**WARNING:** Most of the demonstration certificates supplied with Artix are signed by the CA `cacert.pem`. This CA is completely insecure because anyone can access its private key. To secure your system, you must create new certificates signed by a trusted CA. This chapter describes the set of certificates required by an Artix application and shows you how to replace the default certificates.

### The contents of an X.509 certificate

---

An X.509 certificate contains information about the certificate subject and the certificate issuer (the CA that issued the certificate). A certificate is encoded in Abstract Syntax Notation One (ASN.1), a standard syntax for describing messages that can be sent or received on a network.

The role of a certificate is to associate an identity with a public key value. In more detail, a certificate includes:

- X.509 version information.
- A *serial number* that uniquely identifies the certificate.
- A *subject DN* that identifies the certificate owner.
- The *public key* associated with the subject.
- An *issuer DN* that identifies the CA that issued the certificate.
- The digital signature of the issuer.
- Information about the algorithm used to sign the certificate.
- Some optional X.509 v.3 extensions. For example, an extension exists that distinguishes between CA certificates and end-entity certificates.

### Distinguished names

---

A distinguished name (DN) is a general purpose X.500 identifier that is often used in the context of security.

See [“ASN.1 and Distinguished Names” on page 731](#) for more details about DNs.

---

# Certification Authorities

## Choice of CAs

---

A CA must be trusted to keep its private key secure. When setting up an Artix system, it is important to choose a suitable CA, make the CA certificate available to all applications, and then use the CA to sign certificates for your applications.

There are two types of CA you can use:

- A *commercial CA* is a company that signs certificates for many systems.
- A *private CA* is a trusted node that you set up and use to sign certificates for your system only.

## In this section

---

This section contains the following subsections:

<a href="#">Commercial Certification Authorities</a>	<a href="#">page 175</a>
<a href="#">Private Certification Authorities</a>	<a href="#">page 176</a>

---

## Commercial Certification Authorities

---

### Signing certificates

There are several commercial CAs available. The mechanism for signing a certificate using a commercial CA depends on which CA you choose.

---

### Advantages of commercial CAs

An advantage of commercial CAs is that they are often trusted by a large number of people. If your applications are designed to be available to systems external to your organization, use a commercial CA to sign your certificates. If your applications are for use within an internal network, a private CA might be appropriate.

---

### Criteria for choosing a CA

Before choosing a CA, you should consider the following criteria:

- What are the certificate-signing policies of the commercial CAs?
- Are your applications designed to be available on an internal network only?
- What are the potential costs of setting up a private CA compared with the costs of subscribing to a commercial CA?

---

## Private Certification Authorities

---

### Choosing a CA software package

If you wish to take responsibility for signing certificates for your system, set up a private CA. To set up a private CA, you require access to a software package that provides utilities for creating and signing certificates. Several packages of this type are available.

---

### OpenSSL software package

One software package that allows you to set up a private CA is OpenSSL, <http://www.openssl.org>. OpenSSL is derived from SSLeay, an implementation of SSL developed by Eric Young (eay@cryptsoft.com). Complete license information can be found in [“License Issues” on page 773](#). The OpenSSL package includes basic command line utilities for generating and signing certificates and these utilities are available with every installation of Artix. Complete documentation for the OpenSSL command line utilities is available from <http://www.openssl.org/docs>.

---

### Setting up a private CA using OpenSSL

For instructions on how to set up a private CA, see [“Creating Your Own Certificates” on page 181](#).

---

### Choosing a host for a private certification authority

Choosing a host is an important step in setting up a private CA. The level of security associated with the CA host determines the level of trust associated with certificates signed by the CA.

If you are setting up a CA for use in the development and testing of Artix applications, use any host that the application developers can access. However, when you create the CA certificate and private key, do not make the CA private key available on hosts where security-critical applications run.

---

### Security precautions

If you are setting up a CA to sign certificates for applications that you are going to deploy, make the CA host as secure as possible. For example, take the following precautions to secure your CA:

- Do not connect the CA to a network.
- Restrict all access to the CA to a limited set of trusted users.
- Protect the CA from radio-frequency surveillance using an RF-shield.



---

# Certificate Chaining

---

## Certificate chain

A *certificate chain* is a sequence of certificates, where each certificate in the chain is signed by the subsequent certificate.

---

## Self-signed certificate

The last certificate in the chain is normally a *self-signed certificate*—a certificate that signs itself.

---

## Example

[Figure 23](#) shows an example of a simple certificate chain.

**Figure 23:** A Certificate Chain of Depth 2

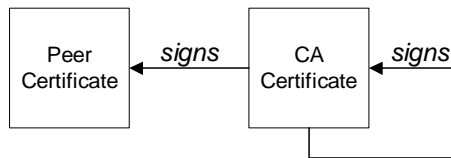

---

## Chain of trust

The purpose of a certificate chain is to establish a chain of trust from a peer certificate to a trusted CA certificate. The CA vouches for the identity in the peer certificate by signing it. If the CA is one that you trust (indicated by the presence of a copy of the CA certificate in your root certificate directory), this implies you can trust the signed peer certificate as well.

---

**Certificates signed by multiple CAs**

A CA certificate can be signed by another CA. For example, an application certificate may be signed by the CA for the finance department of IONA Technologies, which in turn is signed by a self-signed commercial CA. [Figure 24](#) shows what this certificate chain looks like.

**Figure 24:** *A Certificate Chain of Depth 3*

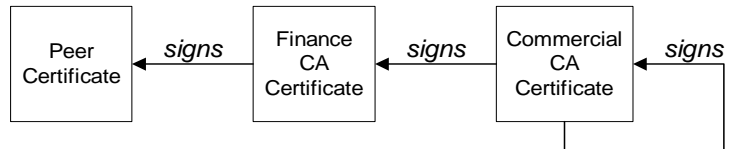

---

**Trusted CAs**

An application can accept a signed certificate if the CA certificate for any CA in the signing chain is available in the certificate file in the local root certificate directory.

See [“Specifying Trusted CA Certificates” on page 206](#).

---

**Maximum chain length policy**

*C++ runtime only*—You can limit the length of certificate chains accepted by your CORBA applications, with the maximum chain length policy. You can set a value for the maximum length of a certificate chain with the `policies:iiop_tls:max_chain_length_policy` configuration variable for IIOP/TLS and the `policies:max_chain_length_policy` configuration variable for HTTPS respectively.

---

# PKCS#12 Files

---

## Overview

Figure 25 shows the typical elements in a PKCS#12 file.

**Figure 25:** *Elements in a PKCS#12 File*

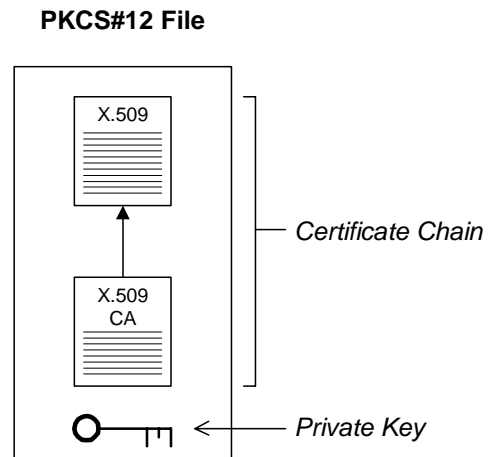

## Contents of a PKCS#12 file

A PKCS#12 file contains the following:

- An X.509 peer certificate (first in a chain).
- All the CA certificates in the certificate chain.
- A private key.

The file is encrypted with a pass phrase.

PKCS#12 is an industry-standard format and is used by browsers such as Netscape and Internet Explorer.

**Note:** The same pass phrase is used both for the encryption of the private key within the PKCS#12 file and for the encryption of the PKCS#12 file overall. This condition (same pass phrase) is not officially part of the PKCS#12 standard, but it is enforced by most Web browsers and by Artix.

---

**Creating a PKCS#12 file**

To create a PKCS#12 file, see [“Use the CA to Create Signed Certificates in a Java Keystore” on page 188](#).

---

**Viewing a PKCS#12 file**

To view a PKCS#12 file, *CertName.p12*:

```
openssl pkcs12 -in CertName.p12
```

---

**Importing and exporting PKCS#12 files**

The generated PKCS#12 files generated by OpenSSL can be imported into browsers such as IE or Netscape. Exported PKCS#12 files from these browsers can be used in Artix.

**Note:** Use OpenSSL v0.9.2 or later; Internet Explorer 5.0 or later; Netscape 4.7 or later.

---

# Creating Your Own Certificates

---

**Overview**

This section describes the steps involved in setting up a CA and signing certificates.

---

**OpenSSL utilities**

The steps described in this section are based on the OpenSSL command-line utilities from the OpenSSL project, <http://www.openssl.org>—see “[OpenSSL Utilities](#)” on [page 743](#). Further documentation of the OpenSSL command-line utilities can be obtained from <http://www.openssl.org/docs>.

---

**Sample CA directory structure**

For the purposes of illustration, the CA database is assumed to have the following directory structure:

```
X509CA/ca
```

```
X509CA/certs
```

```
X509CA/newcerts
```

```
X509CA/cr1
```

Where `X509CA` is the parent directory of the CA database.

---

**In this section**

This section contains the following subsections:

<a href="#">Set Up Your Own CA</a>	<a href="#">page 182</a>
<a href="#">Use the CA to Create Signed Certificates in a Java Keystore</a>	<a href="#">page 188</a>
<a href="#">Use the CA to Create Signed Certificates in a Java Keystore</a>	<a href="#">page 188</a>

---

## Set Up Your Own CA

---

### Substeps to perform

This section describes how to set up your own private CA. Before setting up a CA for a real deployment, read the additional notes in [“Choosing a host for a private certification authority” on page 176](#).

To set up your own CA, perform the following substeps:

- [Step 1—Add the bin directory to your PATH](#)
  - [Step 2—Create the CA directory hierarchy](#)
  - [Step 3—Copy and edit the openssl.cnf file](#)
  - [Step 4—Initialize the CA database](#)
  - [Step 5—Create a self-signed CA certificate and private key](#)
- 

### Step 1—Add the bin directory to your PATH

On the secure CA host, add the OpenSSL `bin` directory to your path:

#### Windows

```
> set PATH=OpenSSLDDir\bin;%PATH%
```

#### UNIX

```
% PATH=OpenSSLDDir/bin:$PATH; export PATH
```

This step makes the `openssl` utility available from the command line.

---

### Step 2—Create the CA directory hierarchy

Create a new directory, `X509CA`, to hold the new CA. This directory will be used to hold all of the files associated with the CA. Under the `X509CA` directory, create the following hierarchy of directories:

```
X509CA/ca  
X509CA/certs  
X509CA/newcerts  
X509CA/crl
```

---

### Step 3—Copy and edit the openssl.cnf file

Copy the sample `openssl.cnf` from your OpenSSL installation to the `X509CA` directory.

Edit the `openssl.cnf` to reflect the directory structure of the `X509CA` directory and to identify the files used by the new CA.

Edit the [CA\_default] section of the openssl.cnf file to make it look like the following:

```
#####
[ CA_default ]

dir           = X509CA           # Where CA files are kept
certs        = $dir/certs       # Where issued certs are kept
crl_dir      = $dir/crl         # Where the issued crl are kept
database     = $dir/index.txt   # Database index file
new_certs_dir = $dir/newcerts   # Default place for new certs

certificate  = $dir/ca/new_ca.pem # The CA certificate
serial       = $dir/serial       # The current serial number
crl          = $dir/crl.pem      # The current CRL
private_key  = $dir/ca/new_ca_pk.pem # The private key
RANDFILE     = $dir/ca/.rand     # Private random number file

x509_extensions = usr_cert     # The extensions to add to the cert
...
```

You might like to edit other details of the OpenSSL configuration at this point—for more details, see [“The OpenSSL Configuration File” on page 758](#).

#### Step 4—Initialize the CA database

In the *X509CA* directory, initialize two files, *serial* and *index.txt*.

##### Windows

```
> echo 01 > serial
```

To create an empty file, *index.txt*, in Windows start a Windows Notepad at the command line in the *X509CA* directory, as follows:

```
> notepad index.txt
```

In response to the dialog box with the text, Cannot find the text.txt file. Do you want to create a new file?, click Yes, and close Notepad.

##### UNIX

```
% echo "01" > serial
% touch index.txt
```

These files are used by the CA to maintain its database of certificate files.

**Note:** The *index.txt* file must initially be completely empty, not even containing white space.

**Step 5—Create a self-signed CA certificate and private key**

Create a new self-signed CA certificate and private key:

```
openssl req -x509 -new -config
  X509CA/openssl.cnf -days 365 -out X509CA/ca/new_ca.pem
  -keyout X509CA/ca/new_ca_pk.pem
```

The command prompts you for a pass phrase for the CA private key and details of the CA distinguished name:

```
Using configuration from X509CA/openssl.cnf
Generating a 512 bit RSA private key
...+++++
.+++++
writing new private key to 'new_ca_pk.pem'
Enter PEM pass phrase:
Verifying password - Enter PEM pass phrase:
-----
You are about to be asked to enter information that will be
incorporated into your certificate request.
What you are about to enter is what is called a Distinguished
Name or a DN. There are quite a few fields but you can leave
some blank. For some fields there will be a default value,
If you enter '.', the field will be left blank.
-----
Country Name (2 letter code) []:IE
State or Province Name (full name) []:Co. Dublin
Locality Name (eg, city) []:Dublin
Organization Name (eg, company) []:IONA Technologies PLC
Organizational Unit Name (eg, section) []:Finance
Common Name (eg, YOUR name) []:Gordon Brown
Email Address []:gbrown@iona.com
```

**Note:** The security of the CA depends on the security of the private key file and private key pass phrase used in this step.

You should ensure that the file names and location of the CA certificate and private key, `new_ca.pem` and `new_ca_pk.pem`, are the same as the values specified in `openssl.cnf` (see the preceding step).

You are now ready to sign certificates with your CA.



---

## Use the CA to Create Signed PKCS#12 Certificates

---

### Substeps to perform

If you have set up a private CA, as described in [“Set Up Your Own CA” on page 182](#), you are now ready to create and sign your own certificates.

To create and sign a certificate in PKCS#12 format, *CertName.p12*, perform the following substeps:

- [Step 1—Add the bin directory to your PATH.](#)
  - [Step 2—Create a certificate signing request.](#)
  - [Step 3—Sign the CSR.](#)
  - [Step 4—Concatenate the files.](#)
  - [Step 5—Create a PKCS#12 file.](#)
  - [Step 6—Repeat steps as required.](#)
- 

### Step 1—Add the bin directory to your PATH

If you have not already done so, add the OpenSSL `bin` directory to your path:

#### Windows

```
> set PATH=OpenSSLDir\bin;%PATH%
```

#### UNIX

```
% PATH=OpenSSLDir/bin:$PATH; export PATH
```

This step makes the `openssl` utility available from the command line.

---

### Step 2—Create a certificate signing request

Create a new certificate signing request (CSR) for the *CertName.p12* certificate:

```
openssl req -new -config X509CA/openssl.cnf
    -days 365 -out X509CA/certs/CertName_csr.pem -keyout
    X509CA/certs/CertName_pk.pem
```

This command prompts you for a pass phrase for the certificate’s private key and information about the certificate’s distinguished name.

Some of the entries in the CSR distinguished name must match the values in the CA certificate (specified in the CA Policy section of the `openssl.cnf` file). The default `openssl.cnf` file requires the following entries to match:

- Country Name
- State or Province Name
- Organization Name

The Common Name must be distinct for every certificate generated by OpenSSL.

```
Using configuration from X509CA/openssl.cnf
Generating a 512 bit RSA private key
.+++++
.+++++
writing new private key to 'X509CA/certs/CertName_pk.pem'
Enter PEM pass phrase:
Verifying password - Enter PEM pass phrase:
-----
You are about to be asked to enter information that will be
incorporated into your certificate request.
What you are about to enter is what is called a Distinguished
Name or a DN. There are quite a few fields but you can leave
some blank. For some fields there will be a default value,
If you enter '.', the field will be left blank.
-----
Country Name (2 letter code) []:IE
State or Province Name (full name) []:Co. Dublin
Locality Name (eg, city) []:Dublin
Organization Name (eg, company) []:IONA Technologies PLC
Organizational Unit Name (eg, section) []:Systems
Common Name (eg, YOUR name) []:Artix
Email Address []:info@iona.com

Please enter the following 'extra' attributes
to be sent with your certificate request
A challenge password []:password
An optional company name []:IONA
```

### Step 3—Sign the CSR

Sign the CSR using your CA:

```
openssl ca -config X509CA/openssl.cnf -days 365 -in
X509CA/certs/CertName_csr.pem -out X509CA/certs/CertName.pem
```

This command requires the pass phrase for the private key associated with the new\_ca.pem CA certificate:

```
Using configuration from X509CA/openssl.cnf
Enter PEM pass phrase:
Check that the request matches the signature
Signature ok
The Subjects Distinguished Name is as follows
countryName          :PRINTABLE:'IE'
stateOrProvinceName  :PRINTABLE:'Co. Dublin'
localityName         :PRINTABLE:'Dublin'
organizationName     :PRINTABLE:'IONA Technologies PLC'
```

```

organizationalUnitName:PRINTABLE:'Systems'
commonName             :PRINTABLE:'Bank Server Certificate'
emailAddress           :IA5STRING:'info@iona.com'
Certificate is to be certified until May 24 13:06:57 2000 GMT (365
    days)
Sign the certificate? [y/n]:y
1 out of 1 certificate requests certified, commit? [y/n]y
Write out database with 1 new entries
Data Base Updated

```

To sign the certificate successfully, you must enter the CA private key pass phrase—see [“Set Up Your Own CA” on page 182](#).

---

#### Step 4—Concatenate the files

Concatenate the CA certificate file, *CertName.pem* certificate file, and *CertName\_pk.pem* private key file as follows:

##### Windows

```

copy X509CA\ca\new_ca.pem +
    X509CA\certs\CertName.pem +
    X509CA\certs\CertName_pk.pem
    X509CA\certs\CertName_list.pem

```

##### UNIX

```

cat X509CA/ca/new_ca.pem
    X509CA/certs/CertName.pem
    X509CA/certs/CertName_pk.pem >
    X509CA/certs/CertName_list.pem

```

---

#### Step 5—Create a PKCS#12 file

Create a PKCS#12 file from the *CertName\_list.pem* file as follows:

```

openssl pkcs12 -export -in X509CA/certs/CertName_list.pem -out
    X509CA/certs/CertName.p12 -name "New cert"

```

---

#### Step 6—Repeat steps as required

Repeat steps 2 to 5, creating a complete set of certificates for your system. A minimum set of Artix certificates must include a set of certificates for the secure Artix services.

---

## Use the CA to Create Signed Certificates in a Java Keystore

---

### Substeps to perform

To create and sign a certificate in a Java keystore (JKS), *CertName.jks*, perform the following substeps:

- [Step 1—Add the Java bin directory to your PATH](#)
- [Step 2—Generate a certificate and private key pair](#)
- [Step 3—Create a certificate signing request](#)
- [Step 4—Sign the CSR](#)
- [Step 5—Convert to PEM format](#)
- [Step 6—Concatenate the files](#)
- [Step 7—Update keystore with the full certificate chain](#)
- [Step 8—Repeat steps as required](#)

---

### Step 1—Add the Java bin directory to your PATH

If you have not already done so, add the Java `bin` directory to your path:

#### Windows

```
> set PATH=JAVA_HOME\bin;%PATH%
```

#### UNIX

```
% PATH=JAVA_HOME/bin:$PATH; export PATH
```

This step makes the `keytool` utility available from the command line.

---

### Step 2—Generate a certificate and private key pair

Open a command prompt and change directory to *KeystoreDir*. Enter the following command:

```
keytool -genkey -dname "CN=Alice, OU=Engineering, O=IONA  
Technologies PLC, ST=Co. Dublin, C=IE" -validity 365 -alias  
CertAlias -keypass CertPassword -keystore CertName.jks  
-storepass CertPassword
```

This `keytool` command, invoked with the `-genkey` option, generates an X.509 certificate and a matching private key. The certificate and key are both placed in a *key entry* in a newly created keystore, *CertName.jks*. Because the specified keystore, *CertName.jks*, did not exist before issuing the command, `keytool` implicitly creates a new keystore.

The `-dname` and `-validity` flags define the contents of the newly created X.509 certificate, specifying the subject DN and days before expiration respectively. For more details about DN format, see [“ASN.1 and Distinguished Names” on page 731](#).

Some parts of the subject DN must match the values in the CA certificate (specified in the CA Policy section of the `openssl.cnf` file). The default `openssl.cnf` file requires the following entries to match:

- Country Name (C)
- State or Province Name (ST)
- Organization Name (O)

**Note:** If you do not observe these constraints, the OpenSSL CA will refuse to sign the certificate (see [“Step 4—Sign the CSR” on page 189](#)).

### Step 3—Create a certificate signing request

Create a new certificate signing request (CSR) for the `CertName.jks` certificate:

```
keytool -certreq -alias CertAlias -file CertName_csr.pem
-keypass CertPassword -keystore CertName.jks -storepass
CertPassword
```

This command exports a CSR to the file, `CertName_csr.pem`.

### Step 4—Sign the CSR

Sign the CSR using your CA:

```
openssl ca -config X509CA/openssl.cnf -days 365 -in
CertName_csr.pem -out CertName.pem
```

To sign the certificate successfully, you must enter the CA private key pass phrase—see [“Set Up Your Own CA” on page 182](#).

**Note:** If you want to sign the CSR using a CA certificate *other* than the default CA, use the `-cert` and `-keyfile` options to specify the CA certificate and its private key file, respectively.

### Step 5—Convert to PEM format

Convert the signed certificate, `CertName.pem`, to PEM only format:

```
openssl x509 -in CertName.pem -out CertName.pem -outform PEM
```

---

**Step 6—Concatenate the files**

Concatenate the CA certificate file and *CertName.pem* certificate file, as follows:

**Windows**

```
copy CertName.pem + X509CA\ca\new_ca.pem CertName.chain
```

**UNIX**

```
cat CertName.pem X509CA/ca/new_ca.pem > CertName.chain
```

---

**Step 7—Update keystore with the full certificate chain**

Update the keystore, *CertName.jks*, by importing the full certificate chain for the certificate:

```
keytool -import -file CertName.chain  
-keypass CertPassword -keystore CertName.jks -storepass  
CertPassword
```

---

**Step 8—Repeat steps as required**

Repeat steps 2 to 7, creating a complete set of certificates for your system.

---

# Generating a Certificate Revocation List

---

## Overview

This section describes how to use an OpenSSL CA to generate a *certificate revocation list* (CRL). A CRL is a list of X.509 certificates that are no longer considered to be valid. You can deploy a CRL file to a secure application, so that the application automatically rejects certificates that appear in the list. For details about how to deploy a CRL file, see [“Specifying a Certificate Revocation List” on page 225](#).

---

## Relationship between a CA and a CRL

In order to generate a certificate revocation list, it is not sufficient simply to assemble a list of certificates that you would like to revoke. The CA, just as it is responsible for creating and signing certificates, is also responsible for revoking certificates. When you decide to revoke a certificate, you must inform the CA, which records this fact in its database.

After revoking certificates, you can ask the CA to generate a signed certificate revocation list.

---

## Steps to revoke certificates

To generate a certificate revocation list, perform the following steps:

- [Step 1—Add the OpenSSL bin directory to your path.](#)
  - [Step 2—Revoke certificates.](#)
  - [Step 3—Generate the CRL file.](#)
  - [Step 4—Check the CRL file.](#)
- 

## Step 1—Add the OpenSSL bin directory to your path

On the secure CA host, add the OpenSSL `bin` directory to your path:

### Windows

```
> set PATH=OpenSSLDir\bin;%PATH%
```

### UNIX

```
% PATH=OpenSSLDir/bin:$PATH; export PATH
```

This step makes the `openssl` utility available from the command line.

**Step 2—Revoke certificates**

To add a certificate, *CertName.pem*, to the revocation list, enter the following command:

```
openssl ca -config X509CA/openssl.cnf -revoke
X509CA/certs/CertName.pem
```

The command prompts you for the CA pass phrase and then revokes the certificate:

```
Using configuration from openssl.cnf
Loading 'screen' into random state - done
Enter pass phrase for C:/temp/artix_40/X509CA/ca/new_ca_pk.pem:
DEBUG[load_index]: unique_subject = "yes"
Adding Entry with serial number 02 to DB for
/C=IE/ST=Dublin/O=IONA/CN=bad_guy
Revoking Certificate 02.
Data Base Updated
```

Repeat this step as many times as necessary to add certificates to the CA's revocation list.

**Note:** If you get the following error while attempting to revoke a certificate:

```
unable to rename C:/temp/artix_40/X509CA/index.txt to
C:/temp/artix_40/X509CA/index.txt.old
reason: File exists
```

Simply delete *index.txt.old* and then try the command again.

**Step 3—Generate the CRL file**

To generate a PEM file, *crl.pem*, containing the CA's complete certificate revocation list, enter the following command:

```
openssl ca -config X509CA/openssl.cnf -gencrl -out crl/crl.pem
```

The command prompts you for the CA pass phrase and then generates the *crl.pem* file:

```
Using configuration from openssl.cnf
Loading 'screen' into random state - done
Enter pass phrase for C:/temp/artix_40/X509CA/ca/new_ca_pk.pem:
DEBUG[load_index]: unique_subject = "yes"
```

**Step 4—Check the CRL file**

Check the contents of the CRL file by converting it to plain text format, using the following command:

```
openssl crl -in crl/crl.pem -text
```



For a single revoked certificate with serial number 02 (that is, the second certificate in the OpenSSL CA's database), the output of this command would look something like the following:

```
Certificate Revocation List (CRL):
  Version 1 (0x0)
  Signature Algorithm: md5WithRSAEncryption
  Issuer: /C=IE/ST=Dublin/O=IONA/CN=CA_for_CRL
  Last Update: Feb 15 10:47:40 2006 GMT
  Next Update: Mar 15 10:47:40 2006 GMT
Revoked Certificates:
  Serial Number: 02
  Revocation Date: Feb 15 10:45:05 2006 GMT
  Signature Algorithm: md5WithRSAEncryption
  69:3e:55:8a:20:a0:57:d2:36:79:f0:34:bb:73:65:1e:1c:a9:
  40:35:8d:c4:e6:b9:77:fd:2b:1f:a8:26:0c:7a:fb:30:67:7f:
  6a:13:74:58:b9:e2:88:e7:ad:c5:d2:62:48:6b:1e:f6:10:0d:
  45:cc:11:cb:6b:48:28:e2:78:ad:f0:cf:fd:d6:57:78:f2:aa:
  19:8b:bc:62:79:9b:90:f7:18:ba:96:dc:7b:a5:b4:d5:bf:0f:
  e8:5e:71:89:4b:38:8c:f8:75:17:dd:ba:74:f1:01:e0:48:d0:
  e4:f4:dd:ea:47:32:8b:70:5e:1d:9a:4a:88:41:ba:bf:b2:39:
  ce:32
-----BEGIN X509 CRL-----
MIIBHTCBhzANBgkqhkiG9w0BAQQFAADBCMQswCQYDVQQGEwJURTEPMA0GA1UECBMG
RHVibGluMQ0wCwYDVQQKEwRJT05BMRMwEQYDVQQDFApDQV9mb3JfQ1JMFw0wNjAy
MTUxMDQ3NDBaFw0wNjAzMTUxMDQ3NDBaMBQwEgIBAhcNMDYwMjE1MTA0NTA1WjAN
BgkqhkiG9w0BAQQFAAOBqQBpPlWKIKBX0jZ58DS7c2UeHKLANY3E5rl3/SsfqCYM
evswZ39qE3RYueKI563F0mJIax72EA1FzBHLa0go4nit8M/91ld48qoZi7xieZuQ
9xi6ltx7pbTVvw/oXnGJSziM+HUX3bp08QHgSNDk9N3qRzKLCf4dmkqIQbq/sjnO
Mg==
-----END X509 CRL-----
```



# Configuring HTTPS and IIOP/TLS Authentication

*This chapter describes how to configure HTTPS and IIOP/TLS authentication requirements for Artix applications.*

---

## **In this chapter**

This chapter discusses the following topics:

<a href="#">Requiring Authentication</a>	page 196
<a href="#">Specifying Trusted CA Certificates</a>	page 206
<a href="#">Specifying an Application's Own Certificate</a>	page 216
<a href="#">Specifying a Certificate Revocation List</a>	page 225
<a href="#">Advanced Configuration Options</a>	page 228

---

# Requiring Authentication

## Overview

---

This section discusses how to specify the kind of authentication required, whether mutual or target-only.

---

## In this section

There are two possible arrangements for a TLS secure association:

<a href="#">Target-Only Authentication</a>	<a href="#">page 197</a>
<a href="#">Mutual Authentication</a>	<a href="#">page 201</a>

## Target-Only Authentication

### Overview

When an application is configured for target-only authentication, the target authenticates itself to the client but the client is not authentic to the target object—see [Figure 26](#).

**Figure 26:** *Target Authentication Only*

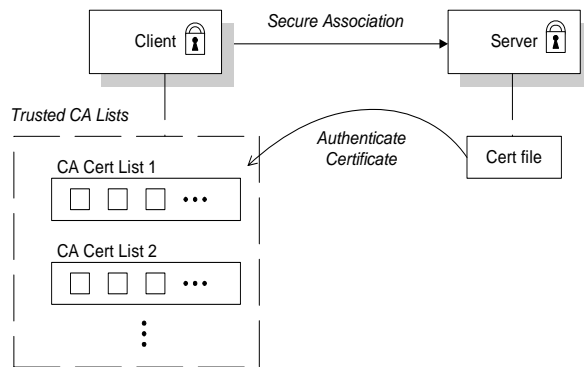

### Security handshake

Prior to running the application, the client and server should be set up as follows:

- *A certificate chain is associated with the server*—the certificate chain is provided either in the form of a PKCS#12 file (C++ runtime) or a Java keystore (Java runtime). See [“Specifying an Application’s Own Certificate”](#) on page 216.
- *One or more lists of trusted certification authorities (CA) are made available to the client*—see [“Specifying Trusted CA Certificates”](#) on page 206.

During the security handshake, the server sends its certificate chain to the client—see [Figure 26](#). The client then searches its trusted CA lists to find a CA certificate that matches one of the CA certificates in the server’s certificate chain.

**HTTPS example, Java runtime**

On the client side, there are no policy settings required for target-only authentication. Simply configure your client *without* associating an X.509 certificate with the HTTPS port. You *do* need to provide the client with a list of trusted CA certificates, however—see [“Specifying Trusted CA Certificates” on page 206](#).

On the server side, in the server’s XML configuration file, ensure that the `sec:clientAuthentication` element does not require client authentication. This element can be omitted, in which case the default policy is *not* to require client authentication. If the `sec:clientAuthentication` element is present, however, it should be configured as follows:

```
<http:destination id="{Namespace}PortName.http-destination">
  <http:tlsServerParameters>
    ...
    <sec:clientAuthentication want="false" required="false"/>
  </http:tlsServerParameters>
</http:destination>
```

Where the `want` attribute is set to `false` (the default), specifying that the server does not request an X.509 certificate from the client during a TLS handshake. The `required` attribute is also set to `false` (the default), specifying that the absence of a client certificate does not trigger an exception during the TLS handshake.

**Note:** As a matter of fact, the `want` attribute could be set either to `true` or to `false`. If `true`, the `want` setting causes the server to request a client certificate during the TLS handshake, but no exception would be raised for clients lacking a certificate, so long as the `required` attribute is `false`.

It is also necessary to associate an X.509 certificate with the server’s HTTPS port (see [“Specifying an Application’s Own Certificate” on page 216](#)) and to provide the server with a list of trusted CA certificates, however (see [“Specifying Trusted CA Certificates” on page 206](#)).

**Note:** The choice of cipher suite can potentially affect whether or not target-only authentication is supported—see [“Configuring HTTPS Cipher Suites—Java Runtime” on page 233](#).

**HTTPS example, C++ runtime**

The following extract from an `artix.cfg` configuration file shows the target-only configuration of an Artix client application, `bank_client`, and an Artix server application, `bank_server`, where the transport type is HTTPS and the application is built using the C++ runtime.

```
# Artix Configuration File
...
policies:https:mechanism_policy:protocol_version = "SSL_V3";
policies:https:mechanism_policy:ciphersuites =
    ["RSA_WITH_RC4_128_SHA", "RSA_WITH_RC4_128_MD5"];

bank_server {
    // Specify server invocation policies
    policies:target_secure_invocation_policy:requires =
        ["Confidentiality", "Integrity", "DetectReplay",
        "DetectMisordering"];
    policies:target_secure_invocation_policy:supports =
        ["Confidentiality", "Integrity", "DetectReplay",
        "DetectMisordering", "EstablishTrustInTarget"];
    ...
    // Specify server's own certificate (not shown)
    ...
};

bank_client {
    // Specify client invocation policies
    policies:client_secure_invocation_policy:requires =
        ["Confidentiality", "EstablishTrustInTarget"];
    policies:client_secure_invocation_policy:supports =
        ["Confidentiality", "Integrity", "DetectReplay",
        "DetectMisordering", "EstablishTrustInTarget"];
    ...
    // Specify client's trusted CA certs (not shown)
    ...
};
```

**IIOP/TLS example**

The following extract from an `artix.cfg` configuration file shows the target-only configuration of an Artix client application, `bank_client`, and an Artix server application, `bank_server`, where the transport type is IIOP/TLS.

```
# Artix Configuration File
...
policies:iiop_tls:mechanism_policy:protocol_version = "SSL_V3";
policies:iiop_tls:mechanism_policy:ciphersuites =
    ["RSA_WITH_RC4_128_SHA", "RSA_WITH_RC4_128_MD5"];

bank_server {
    // Specify server invocation policies
    policies:iiop_tls:target_secure_invocation_policy:requires =
        ["Confidentiality", "Integrity", "DetectReplay",
        "DetectMisordering"];
    policies:iiop_tls:target_secure_invocation_policy:supports =
        ["Confidentiality", "Integrity", "DetectReplay",
        "DetectMisordering", "EstablishTrustInTarget"];
    ...
    // Specify server's own certificate (not shown)
    ...
};

bank_client {
    // Specify client invocation policies
    policies:iiop_tls:client_secure_invocation_policy:requires =
        ["Confidentiality", "EstablishTrustInTarget"];
    policies:iiop_tls:client_secure_invocation_policy:supports =
        ["Confidentiality", "Integrity", "DetectReplay",
        "DetectMisordering", "EstablishTrustInTarget"];
    ...
    // Specify client's trusted CA certs (not shown)
    ...
};
```

**Note:** If using the Java runtime, you must first associate the client or server with a configuration file—see [“Configuring the Java Runtime CORBA Binding”](#) on page 765 for details.



# Mutual Authentication

## Overview

When an application is configured for mutual authentication, the target authenticates itself to the client and the client authenticates itself to the target. This scenario is illustrated in Figure 27. In this case, the server and the client each require an X.509 certificate for the security handshake.

Figure 27: Mutual Authentication

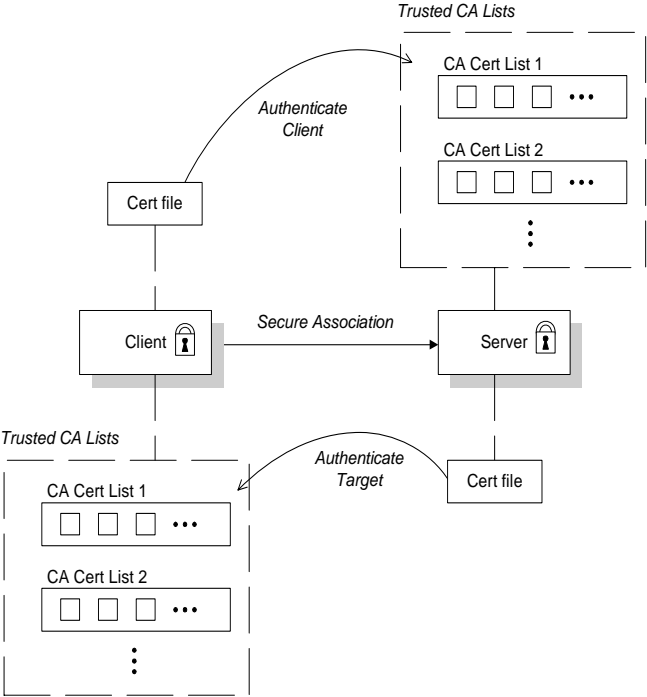

**Security handshake**

Prior to running the application, the client and server should be set up as follows:

- Both client and server have an associated certificate chain (PKCS#12 file)—see [“Specifying an Application’s Own Certificate” on page 216](#).
- Both client and server are configured with lists of trusted certification authorities (CA)—see [“Specifying Trusted CA Certificates” on page 206](#).

During the security handshake, the server sends its certificate chain to the client, and the client sends its certificate chain to the server—see [Figure 26](#).

**HTTPS example, Java runtime**

On the client side, there are no policy settings required for mutual authentication. Simply associate an X.509 certificate with the client’s HTTPS port—see [“Specifying an Application’s Own Certificate” on page 216](#). You also need to provide the client with a list of trusted CA certificates—see [“Specifying Trusted CA Certificates” on page 206](#).

On the server side, in the server’s XML configuration file, ensure that the `sec:clientAuthentication` element is configured to *require* client authentication, as follows:

```
<http:destination id="{Namespace}PortName.http-destination">
  <http:tlsServerParameters>
    ...
    <sec:clientAuthentication want="true" required="true"/>
  </http:tlsServerParameters>
</http:destination>
```

Where the `want` attribute is set to `true`, specifying that the server requests an X.509 certificate from the client during a TLS handshake. The `required` attribute is also set to `true`, specifying that the absence of a client certificate would trigger an exception during the TLS handshake.

It is also necessary to associate an X.509 certificate with the server’s HTTPS port (see [“Specifying an Application’s Own Certificate” on page 216](#)) and to provide the server with a list of trusted CA certificates, however (see [“Specifying Trusted CA Certificates” on page 206](#)).

**Note:** The choice of cipher suite can potentially affect whether or not mutual authentication is supported—see [“Configuring HTTPS Cipher Suites—Java Runtime” on page 233](#).

**HTTPS example, C++ runtime**

The following sample extract from an `artix.cfg` configuration file shows the configuration for mutual authentication of a client application, `secure_client_with_cert`, and a server application, `secure_server_enforce_client_auth`, where the transport type is HTTPS and the application uses the C++ runtime.

```
# Artix Configuration File
...
policies:https:mechanism_policy:protocol_version = "SSL_V3";
policies:https:mechanism_policy:ciphersuites =
    ["RSA_WITH_RC4_128_SHA", "RSA_WITH_RC4_128_MD5"];

secure_server_enforce_client_auth
{
    // Specify server invocation policies
    policies:target_secure_invocation_policy:requires =
        ["EstablishTrustInClient", "Confidentiality", "Integrity",
        "DetectReplay", "DetectMisordering"];
    policies:target_secure_invocation_policy:supports =
        ["EstablishTrustInClient", "Confidentiality", "Integrity",
        "DetectReplay", "DetectMisordering",
        "EstablishTrustInTarget"];
    ...
    // Specify server's own certificate (not shown)
    ...
    // Specify server's trusted CA certs (not shown)
    ...
};

secure_client_with_cert
{
    // Specify client invocation policies
    policies:client_secure_invocation_policy:requires =
        ["Confidentiality", "EstablishTrustInTarget"];
    policies:client_secure_invocation_policy:supports =
        ["Confidentiality", "Integrity", "DetectReplay",
        "DetectMisordering", "EstablishTrustInClient",
        "EstablishTrustInTarget"];
    ...
    // Specify client's own certificate (not shown)
    ...
    // Specify client's trusted CA certs (not shown)
    ...
};
```

## IIOP/TLS example

The following sample extract from an `artix.cfg` configuration file shows the configuration for mutual authentication of a client application, `secure_client_with_cert`, and a server application, `secure_server_enforce_client_auth`, where the transport type is IIOP/TLS.

```
# Artix Configuration File
...
policies:iiop_tls:mechanism_policy:protocol_version = "SSL_V3";
policies:iiop_tls:mechanism_policy:ciphersuites =
    ["RSA_WITH_RC4_128_SHA", "RSA_WITH_RC4_128_MD5"];

secure_server_enforce_client_auth
{
    // Specify server invocation policies
    policies:iiop_tls:target_secure_invocation_policy:requires =
        ["EstablishTrustInClient", "Confidentiality", "Integrity",
        "DetectReplay", "DetectMisordering"];
    policies:iiop_tls:target_secure_invocation_policy:supports =
        ["EstablishTrustInClient", "Confidentiality", "Integrity",
        "DetectReplay", "DetectMisordering",
        "EstablishTrustInTarget"];
    ...
    // Specify server's own certificate (not shown)
    ...
    // Specify server's trusted CA certs (not shown)
    ...
};

secure_client_with_cert
{
    // Specify client invocation policies
    policies:iiop_tls:client_secure_invocation_policy:requires =
        ["Confidentiality", "EstablishTrustInTarget"];
    policies:iiop_tls:client_secure_invocation_policy:supports =
        ["Confidentiality", "Integrity", "DetectReplay",
        "DetectMisordering", "EstablishTrustInClient",
        "EstablishTrustInTarget"];
    ...
    // Specify client's own certificate (not shown)
    ...
    // Specify client's trusted CA certs (not shown)
    ...
};
```

**Note:** If using the Java runtime, you must first associate the client or server with a configuration file—see [“Configuring the Java Runtime CORBA Binding”](#) on page 765 for details.

---

# Specifying Trusted CA Certificates

## Overview

---

When an application receives an X.509 certificate during an SSL/TLS handshake, the application decides whether or not to trust the received certificate by checking whether the issuer CA is one of a pre-defined set of trusted CA certificates. If the received X.509 certificate is validly signed by one of the application's trusted CA certificates, the certificate is deemed trustworthy; otherwise, it is rejected.

---

## Which applications need to specify trusted CA certificates?

Any application that is likely to receive an X.509 certificate as part of an HTTPS or IIOp/TLS handshake must specify a list of trusted CA certificates. For example, this includes the following types of application:

- All IIOp/TLS or HTTPS clients.
  - Any IIOp/TLS or HTTPS servers that support *mutual authentication*.
- 

## In this section

This section contains the following subsections:

<a href="#">Specifying Trusted CA Certificates for HTTPS—Java Runtime</a> page 207
<a href="#">Specifying Trusted CA Certificates for HTTPS—C++ Runtime</a> page 209
<a href="#">Specifying Trusted CA Certificates for IIOp/TLS</a> page 214

---

## Specifying Trusted CA Certificates for HTTPS—Java Runtime

---

### CA certificate format

CA certificates must be provided in Java keystore format.

---

### CA certificate deployment in the Artix configuration file

To deploy one or more trusted root CAs for the HTTPS transport (Java runtime), perform the following steps:

1. Assemble the collection of trusted CA certificates that you want to deploy. The trusted CA certificates could be obtained from public CAs or private CAs (for details of how to generate your own CA certificates, see [“Set Up Your Own CA” on page 182](#)). The trusted CA certificates can be in any format that is compatible with the Java `keytool` utility—for example, PEM format. All you need are the certificates themselves—the private keys and passwords are not required.
2. Given a CA certificate, `cacert.pem`, in PEM format, you can add the certificate to a JKS truststore (or create a new truststore) by entering the following command:

```
keytool -import -file cacert.pem -alias CAAlias -keystore truststore.jks -storepass StorePass
```

Where `CAAlias` is a convenient tag that enables you to access this particular CA certificate using the `keytool` utility. The file, `truststore.jks`, is a keystore file containing CA certificates—if this file does not already exist, the `keytool` utility will create it. The `StorePass` password provides access to the keystore file, `truststore.jks`.

3. Repeat step 2 as necessary, to add all of the CA certificates to the truststore file, `truststore.jks`.

4. Edit the relevant XML configuration files to specify the location of the truststore file. You need to include the `sec:trustManagers` element in the configuration of the relevant HTTPS ports.

For example, you would configure a client port as follows:

```
<!-- Client port configuration -->
<http:conduit id="{Namespace}PortName.http-conduit">
  <http:tlsClientParameters>
    ...
    <sec:trustManagers>
      <sec:keyStore type="JKS"
                    password="StorePass"
                    file="certs/truststore.jks"/>
    </sec:trustManagers>
    ...
  </http:tlsClientParameters>
</http:conduit>
```

Where the `type` attribute specifies that the truststore uses the JKS keystore implementation and `StorePass` is the password needed to access the `truststore.jks` keystore.

Configure a server port as follows:

```
<!-- Server port configuration -->
<http:destination
  id="{Namespace}PortName.http-destination">
  <http:tlsServerParameters>
    ...
    <sec:trustManagers>
      <sec:keyStore type="JKS"
                    password="StorePass"
                    file="certs/truststore.jks"/>
    </sec:trustManagers>
    ...
  </http:tlsServerParameters>
</http:destination>
```

**WARNING:** The directory containing the truststores (for example, `X509Deploy/truststores/`) should be a secure directory (that is, writable only by the administrator).



---

## Specifying Trusted CA Certificates for HTTPS—C++ Runtime

---

### CA certificate format

CA certificates must be provided in Privacy Enhanced Mail (PEM) format.

The PEM format is a proprietary format. You can use the OpenSSL command-line tools to convert certificates to and from the PEM format. For example, to convert a CA file, `ca.der`, from DER format to PEM format, use the following `openssl` command:

```
openssl x509 -inform DER -outform PEM -in ca.der -out ca.pem
```

Where `ca.pem` is the converted PEM format file.

---

### CA certificate deployment in the Artix configuration file

To deploy one or more trusted root CAs for the HTTPS transport (C++ runtime), perform the following steps (the procedure for client and server applications is the same):

1. Assemble the collection of trusted CA certificates that you want to deploy. The trusted CA certificates could be obtained from public CAs or private CAs (for details of how to generate your own CA certificates, see [“Set Up Your Own CA” on page 182](#)). The trusted CA certificates should be in PEM format. All you need are the certificates themselves—the private keys and passwords are not required.
2. Organize the CA certificates into a collection of CA list files. For example, you might create three CA list files as follows:

```
X509Deploy/trusted_ca_lists/ca_list01.pem
X509Deploy/trusted_ca_lists/ca_list02.pem
X509Deploy/trusted_ca_lists/ca_list03.pem
```

Each CA list file consists of a concatenated list of CA certificates in PEM format. A CA list file can be created using a simple file concatenation operation. For example, if you have two CA certificate files, `ca_cert01.pem` and `ca_cert02.pem`, you could combine them into a single CA list file, `ca_list01.pem`, with the following command:

#### Windows

```
copy X509CA\ca\ca_cert01.pem +
    X509CA\ca\ca_cert02.pem
    X509Deploy\trusted_ca_lists\ca_list01.pem
```

**UNIX**

```
cat X509CA/ca/ca_cert01.pem X509CA/ca/ca_cert02.pem >>
    X509Deploy/trusted_ca_lists/ca_list01.pem
```

The CA certificates are organized as lists as a convenient way of grouping related CA certificates together.

3. Edit your Artix configuration file to specify the locations of the CA list files to be used by your application. To specify the CA list files, go to the relevant configuration scope in the Artix configuration file and edit the value of the `policies:https:trusted_ca_list_policy` configuration variable for the HTTPS transport.

For example, if your application picks up its configuration from the `SecureAppScope` configuration scope and you want to include the CA certificates from the `ca_list01.pem` and `ca_list02.pem` files, edit the Artix configuration file as follows:

```
# Artix configuration file.
...
SecureAppScope {
    ...
    policies:https:trusted_ca_list_policy =
    ["X509Deploy/trusted_ca_lists/ca_list01.pem",
    "X509Deploy/trusted_ca_lists/ca_list02.pem"];
    ...
};
```

The directory containing the trusted CA certificate lists (for example, `X509Deploy/trusted_ca_lists/`) should be a secure directory.

**Note:** If an application supports authentication of a peer, that is a client supports `EstablishTrustInTarget`, then a file containing trusted CA certificates *must* be provided. If not, a `NO_RESOURCES` exception is raised.

### Alternative CA certificate deployment in the Artix configuration file

Alternatively, the `at_http` plug-in supports configuration variables that let you specify the CA certificate list separately for the client role and the server role.

Edit the Artix configuration file by adding (or modifying) the `plugins:at_http:client:trusted_root_certificates` and `plugins:at_http:server:trusted_root_certificates` configuration variables, as follows:

```
secure_app {
  plugins:at_http:client:use_secure_sockets="true";
  plugins:at_http:client:trusted_root_certificates =
  "X509Deploy/trusted_ca_lists/ca_list01.pem";
  ...
  plugins:at_http:server:trusted_root_certificates =
  "X509Deploy/trusted_ca_lists/ca_list02.pem";
  ...
};
```

**Note:** These settings take precedence over the `policies:https:trusted_ca_list_policy` variable.

### Alternative CA certificate deployment by configuring the WSDL contract

Alternatively, the HTTPS transport (C++ runtime) lets you specify the location of a CA list file by configuring the WSDL contract. An advantage of this approach is that it allows you to specify trusted CA lists independently for each port.

**Note:** The settings in the WSDL contract take precedence over the settings in the Artix configuration file.

Edit the WSDL contract to specify the location of the CA list file. The details of this step depend on whether you are deploying a trusted CA list on the client side or on the server side.

**Client side**

Edit the client's copy of the WSDL contract by adding (or modifying) the `TrustedRootCertificates` attribute in the `<http-conf:client>` tag. For example, to specify `X509CA/ca/ca_list01.pem` as the client's trusted CA certificate list, modify the client's WSDL contract as follows:

```
<definitions
xmlns:http="http://schemas.iona.com/transport/http"
xmlns:http-conf="http://schemas.iona.com/transport/http/configu
ration" ... >
...
<service name="...">
  <port binding="...">
    <http-conf:client ...
      TrustedRootCertificates="X509CA/ca/ca_list01.pem"
      ... />
    ...
  </port>
</service>
```

**WARNING:** If you include security settings in the WSDL contract and you have loaded the WSDL publish plug-in, it is recommended that you configure the WSDL publishing service to be secure. See [“Publishing WSDL Securely—C++ Runtime” on page 419](#).

**Server side**

Edit the server's copy of the WSDL contract by adding (or modifying) the `TrustedRootCertificates` attribute in the `<http-conf:server>` tag. For example, to specify `X509CA/ca/ca_list01.pem` as the server's trusted CA certificate list, modify the server's WSDL contract as follows:

```
<definitions
xmlns:http="http://schemas.iona.com/transport/http"
xmlns:http-conf="http://schemas.iona.com/transport/http/configu
ration" ... >
...
<service name="...">
  <port binding="...">
    ...
    <http-conf:server ...
      TrustedRootCertificates="X509CA/ca/ca_list01.pem"
      ... />
  </port>
</service>
```

**WARNING:** If you include security settings in the WSDL contract and you have loaded the WSDL publish plug-in, it is recommended that you configure the WSDL publishing service to be secure. See [“Publishing WSDL Securely—C++ Runtime” on page 419](#).

---

## Specifying Trusted CA Certificates for IOP/TLS

---

### CA certificate format

CA certificates must be provided in Privacy Enhanced Mail (PEM) format.

---

### CA certificate deployment in the Artix configuration file

To deploy one or more trusted root CAs for the IOP/TLS transport, perform the following steps (the procedure for client and server applications is the same):

1. Assemble the collection of trusted CA certificates that you want to deploy. The trusted CA certificates could be obtained from public CAs or private CAs (for details of how to generate your own CA certificates, see [“Set Up Your Own CA” on page 182](#)). The trusted CA certificates should be in PEM format. All you need are the certificates themselves—the private keys and passwords are not required.
2. Organize the CA certificates into a collection of CA list files. For example, you might create three CA list files as follows:

```
X509Deploy/trusted_ca_lists/ca_list01.pem
X509Deploy/trusted_ca_lists/ca_list02.pem
X509Deploy/trusted_ca_lists/ca_list03.pem
```

Each CA list file consists of a concatenated list of CA certificates in PEM format. A CA list file can be created using a simple file concatenation operation. For example, if you have two CA certificate files, `ca_cert01.pem` and `ca_cert02.pem`, you could combine them into a single CA list file, `ca_list01.pem`, with the following command:

#### Windows

```
copy X509CA\ca\ca_cert01.pem +
    X509CA\ca\ca_cert02.pem
    X509Deploy\trusted_ca_lists\ca_list01.pem
```

#### UNIX

```
cat X509CA/ca/ca_cert01.pem X509CA/ca/ca_cert02.pem >>
    X509Deploy/trusted_ca_lists/ca_list01.pem
```

The CA certificates are organized as lists as a convenient way of grouping related CA certificates together.

3. Edit the Artix configuration file to specify the locations of the CA list files to be used by your application. For example, the default Artix configuration file is located in the following directory:

```
ArtixInstallDir/cxx_java/etc/domains
```

To specify the CA list files, go to your application's configuration scope in the Artix configuration file and edit the value of the `policies:iiop_tls:trusted_ca_list_policy` configuration variable for the IIOP/TLS transport.

**Note:** If using the Java runtime, you must first associate the client or server with a configuration file—see [“Configuring the Java Runtime CORBA Binding” on page 765](#) for details.

For example, if your application picks up its configuration from the `SecureAppScope` configuration scope and you want to include the CA certificates from the `ca_list01.pem` and `ca_list02.pem` files, edit the Artix configuration file as follows:

```
# Artix configuration file.
...
SecureAppScope {
    ...
    policies:iiop_tls:trusted_ca_list_policy =
    ["X509Deploy/trusted_ca_lists/ca_list01.pem",
    "X509Deploy/trusted_ca_lists/ca_list02.pem"];
    ...
};
```

The directory containing the trusted CA certificate lists (for example, `X509Deploy/trusted_ca_lists/`) should be a secure directory.

**Note:** If an application supports authentication of a peer, that is a client supports `EstablishTrustInTarget`, then a file containing trusted CA certificates *must* be provided. If not, a `NO_RESOURCES` exception is raised.

---

# Specifying an Application's Own Certificate

---

## Overview

To enable an Artix application to identify itself, it must be associated with an X.509 certificate. The X.509 certificate is needed during an SSL/TLS handshake, where it is used to authenticate the application to its peers.

---

## Converting legacy certificates

For applications built using the Artix C++ runtime, certificates must be supplied in PKCS#12 format. If you have any legacy certificates in PEM format, you can convert them to PKCS#12 format using the `openssl` command-line utility, as follows:

### Windows

Given the CA signing certificate, `CACert.pem`, the application certificate, `Cert.pem`, and its private key, `PrivKey.pem`, enter the following at a Windows command prompt:

```
> copy CACert.pem + Cert.pem + PrivKey.pem CertList.pem
> openssl pkcs12 -export -in CertList.pem -out Cert.p12
```

### UNIX

Given the CA signing certificate, `CACert.pem`, the application certificate, `Cert.pem`, and its private key, `PrivKey.pem`, enter the following at a UNIX command prompt:

```
> cat CACert.pem Cert.pem PrivKey.pem > CertList.pem
> openssl pkcs12 -export -in CertList.pem -out Cert.p12
```

---

## In this section

This section contains the following subsection:

<a href="#">Deploying Own Certificate for HTTPS—Java Runtime</a>	<a href="#">page 217</a>
<a href="#">Deploying Own Certificate for HTTPS—C++ Runtime</a>	<a href="#">page 219</a>
<a href="#">Deploying Own Certificate for IIOP/TLS</a>	<a href="#">page 223</a>



---

## Deploying Own Certificate for HTTPS—Java Runtime

---

### Own certificate deployment in the XML configuration file

To deploy an Artix application's own certificate for the HTTPS transport using the Java runtime, perform the following steps:

1. Obtain an application certificate in Java keystore format, *CertName.jks*. For instructions on how to create a certificate in Java keystore format, see [“Use the CA to Create Signed Certificates in a Java Keystore” on page 188](#).
2. Copy the certificate's keystore, *CertName.jks*, to the certificates directory—for example, *X509Deploy/certs*—on the deployment host. The certificates directory should be a secure directory that is writable only by administrators and other privileged users.
3. Edit the relevant XML configuration file to specify the location of the certificate keystore, *CertName.jks*. You need to include the `sec:keyManagers` element in the configuration of the relevant HTTPS ports.

For example, you would configure a client port as follows:

```
<http:conduit id="{Namespace}PortName.http-conduit">
  <http:tlsClientParameters>
    ...
    <sec:keyManagers keyPassword="CertPassword">
      <sec:keyStore type="JKS"
        password="CertPassword"
        file="certs/CertName.jks"/>
    </sec:keyManagers>
    ...
  </http:tlsClientParameters>
</http:conduit>
```

Where the `keyPassword` attribute specifies the password needed to decrypt the certificate's private key (that is, *CertPassword*), the `type` attribute specifies that the truststore uses the JKS keystore implementation, and the `password` attribute specifies the password needed to access the *CertName.jks* keystore (that is, *CertPassword*). In this example, it is assumed that the private key password is the same as the keystore password.

Configure a server port as follows:

```
<http:destination
  id="{Namespace}PortName.http-destination">
  <http:tlsServerParameters>
    ...
    <sec:keyManagers keyPassword="CertPassword">
      <sec:keyStore type="JKS"
        password="CertPassword"
        file="certs/CertName.jks"/>
    </sec:keyManagers>
    ...
  </http:tlsServerParameters>
</http:destination>
```

**WARNING:** The directory containing the application certificates (for example, *X509Deploy/certs/*) should be a secure directory (that is, readable and writable only by the administrator).

**WARNING:** The directory containing the XML configuration file should be a secure directory (that is, readable and writable only by the administrator), because the configuration file contains passwords in plain text.

## Deploying Own Certificate for HTTPS—C++ Runtime

### Own certificate deployment in the Artix configuration file

To deploy an Artix application's own certificate, *CertName.p12*, for the HTTPS transport using the C++ runtime, perform the following steps:

1. Copy the application certificate, *CertName.p12*, to the certificates directory—for example, *X509Deploy/certs/applications*—on the deployment host.

The certificates directory should be a secure directory that is accessible only to administrators and other privileged users.

2. Edit the Artix configuration file (for example, *ArtixInstallDir/cxx\_java/etc/domains/artix.cfg*). Given that your application picks up its configuration from the *SecureAppScope* scope, change the principal sponsor configuration to specify the *CertName.p12* certificate, as follows:

```
# Artix configuration file
...
SecureAppScope {
    ...
    principal_sponsor:https:use_principal_sponsor = "true";
    principal_sponsor:https:auth_method_id = "pkcs12_file";
    principal_sponsor:https:auth_method_data =
        ["filename=X509Deploy/certs/applications/CertName.p12"];
};
```

3. By default, the application will prompt the user for the certificate pass phrase as it starts up. Other alternatives for supplying the certificate pass phrase are, as follows:

- ◆ *In a password file*—you can specify the location of a password file that contains the certificate pass phrase by setting the `password_file` option in the `principal_sponsor:https:auth_method_data` configuration setting. For example:

```
principal_sponsor:https:auth_method_data =
    ["filename=X509Deploy/certs/applications/CertName.p12",
     "password_file=X509Deploy/certs/CertName.pwf"];
```

**WARNING:** Because the password file stores the pass phrase in plain text, the password file should not be readable or writable by anyone except the administrator.

- ◆ *Directly in configuration*—you can specify the certificate pass phrase directly in configuration by setting the `password` option in the `principal_sponsor:https:auth_method_data` configuration setting. For example:

```
principal_sponsor:https:auth_method_data =
  ["filename=X509Deploy/certs/applications/CertName.p12",
   "password=CertNamePass"];
```

**WARNING:** If the pass phrase is stored directly in configuration, the Artix configuration file should not be readable or writable by anyone except the administrator.

### Alternative own certificate deployment in the Artix configuration file

Alternatively, the `at_http` plug-in supports configuration variables that let you specify the location of an application's PKCS#12 separately for the client role and the server role.

Edit the Artix configuration file by adding (or modifying) the following highlighted configuration variables, as follows:

```
secure_app {
  plugins:at_http:client:use_secure_sockets="true";
  // Client certificate settings.
  plugins:at_http:client:client_certificate =
  "X509Deploy/certs/applications/CertName.p12";
  plugins:at_http:client:client_private_key_password =
  "MyKeyPassword";
  ...
  // Server certificate settings.
  plugins:at_http:server:server_certificate =
  "X509Deploy/certs/applications/CertName.p12";
  plugins:at_http:server:server_private_key_password =
  "MyKeyPassword";
  ...
};
```

**Note:** These settings take precedence over the `principal_sponsor:https` settings.

### Alternative own certificate deployment by configuring the WSDL contract

Alternatively, the HTTPS transport (C++ runtime) lets you specify the location of an application's PKCS#12 file by configuring the WSDL contract.

**Note:** The settings in the WSDL contract take precedence over the settings in your Artix configuration file.

Edit the WSDL contract to specify the location of the application's PKCS#12 file. The details of this step depend on whether you are deploying certificates on the client side or on the server side:

#### Client side

Edit the client's copy of the WSDL contract by adding (or modifying) the following highlighted attributes in the `<http-conf:client>` tag:

```
<definitions
xmlns:http="http://schemas.iona.com/transport/http"
xmlns:http-conf="http://schemas.iona.com/transport/http/configuration" ... >
...
<service name="...">
  <port binding="...">
    <soap:address ...>
      <http-conf:client UseSecureSockets="true"
        ClientCertificate="X509Deploy/certs/applications/CertName.p12"
        ClientPrivateKeyPassword="MyKeyPassword"
        TrustedRootCertificates="RootCertPath"
        ... />
    </port>
  </service>
```

**WARNING:** If you include security settings in the WSDL contract and you have loaded the WSDL publish plug-in, it is recommended that you configure the WSDL publishing service to be secure. See [“Publishing WSDL Securely—C++ Runtime” on page 419](#).

**Server side**

Edit the server's copy of the WSDL contract by adding (or modifying) the following highlighted attributes in the `<http-conf:server>` tag:

```
<definitions
xmlns:http="http://schemas.iona.com/transport/http"
xmlns:http-conf="http://schemas.iona.com/transport/http/configuration" ... >
...
<service name="...">
  <port binding="...">
    <soap:address ...>
      <http-conf:server UseSecureSockets="true"
ServerCertificate="X509Deploy/certs/applications/CertName.p12"
ServerPrivateKeyPassword="MyKeyPassword"
TrustedRootCertificates="RootCertPath"
... />
    </port>
  </service>
```

**Note:** Because the private key passwords in the WSDL contracts appear in plaintext form, you must ensure that the WSDL contract files themselves are not readable/writable by every user. Use the operating system to restrict read/write access to trusted users only.

Additionally, to avoid revealing the server's security configuration to clients, you should remove the `<http-conf:server>` tag from the client copy of the WSDL contract.

**WARNING:** If you include security settings in the WSDL contract and you have loaded the WSDL publish plug-in, it is recommended that you configure the WSDL publishing service to be secure. See [“Publishing WSDL Securely—C++ Runtime” on page 419](#).

---

## Deploying Own Certificate for IIOP/TLS

---

### Own certificate deployment in the Artix configuration file

To deploy an Artix application's own certificate, *CertName.p12*, for the IIOP/TLS transport, perform the following steps:

1. Copy the application certificate, *CertName.p12*, to the certificates directory—for example, *X509Deploy/certs/applications*—on the deployment host.

The certificates directory should be a secure directory that is accessible only to administrators and other privileged users.

2. Edit the Artix configuration file.

**Note:** If using the Java runtime, you must first associate the client or server with a configuration file—see [“Configuring the Java Runtime CORBA Binding” on page 765](#) for details.

Given that your application picks up its configuration from the *SecureAppScope* scope, change the principal sponsor configuration to specify the *CertName.p12* certificate, as follows:

```
# Artix configuration file
...
SecureAppScope {
    ...
    principal_sponsor:iiop_tls:use_principal_sponsor = "true";
    principal_sponsor:iiop_tls:auth_method_id = "pkcs12_file";
    principal_sponsor:iiop_tls:auth_method_data =
        ["filename=X509Deploy/certs/applications/CertName.p12"];
};
```

3. By default, the application will prompt the user for the certificate pass phrase as it starts up. Other alternatives for supplying the certificate pass phrase are, as follows:

- ◆ *In a password file*—you can specify the location of a password file that contains the certificate pass phrase by setting the `password_file` option in the `principal_sponsor:auth_method_data` configuration setting. For example:

```
principal_sponsor:auth_method_data =
  ["filename=X509Deploy/certs/applications/CertName.p12",
   "password_file=X509Deploy/certs/CertName.pwf"];
```

**WARNING:** Because the password file stores the pass phrase in plain text, the password file should not be readable by anyone except the administrator.

- ◆ *Directly in configuration*—you can specify the certificate pass phrase directly in configuration by setting the `password` option in the `principal_sponsor:auth_method_data` configuration setting. For example:

```
principal_sponsor:auth_method_data =
  ["filename=X509Deploy/certs/applications/CertName.p12",
   "password=CertNamePass"];
```

**WARNING:** If the pass phrase is stored directly in configuration, the Artix configuration file should not be readable by anyone except the administrator.



---

# Specifying a Certificate Revocation List

## Overview

Occasionally, it can happen that the security of an X.509 certificate is compromised or you might want to invalidate a certificate, because the owner of the certificate no longer enjoys the same security privileges as before. In either of these cases, it is useful to generate and deploy a *certificate revocation list* (CRL). A CRL is a list of X.509 certificates that are no longer valid. When you deploy a CRL file to a secure application, the application automatically rejects the certificates that appear in the list.

## Revoking CA certificates

You can also revoke a CA certificate, in which case all of the certificates signed by the CA are implicitly revoked as well.

## Configuring certificate revocation—Java runtime

[Example 39](#) shows how to configure a Java runtime application to use a CRL file.

### Example 39: Configuration of a CRL—Java Runtime

```
<?xml version="1.0" encoding="UTF-8"?>
<beans xmlns="http://www.springframework.org/schema/beans"
  xmlns:xsi="http://www.w3.org/2001/XMLSchema-instance"
  xmlns:asec="http://cxf.iona.com/security/rt/configuration"
  xmlns:csec="http://cxf.apache.org/configuration/security"
  xmlns:http="http://cxf.apache.org/transports/http/configuration"
  xmlns:httpj="http://cxf.apache.org/transports/http-jetty/configu
    ration"
  xmlns:jaxws="http://cxf.apache.org/jaxws"
  ... >
  ...
  1 <jaxws:endpoint
    name="{http://apache.org/hello_world_soap_http}SoapPort"
      createdFromAPI="true">
  2   <jaxws:inInterceptors>
     <ref bean="MyCRLTrustInterceptor"/>
     </jaxws:inInterceptors>
  </jaxws:endpoint>
  ...
  3 <asec:crlTrustInterceptor name="MyCRLTrustInterceptor">
  4   <asec:crls file="certs/ca.crl"/>
  </asec:crlTrustInterceptor>
```

**Example 39:** Configuration of a CRL—Java Runtime

```
...
</beans>
```

The preceding configuration can be explained as follows:

1. The configuration settings in the `jaxws:endpoint` element are applied to the endpoint identified by the QName, `{http://apache.org/hello_world_soap_http}SoapPort`.
2. The `jaxws:inInterceptor` element installs an interceptor to the incoming handler chain. The referenced interceptor, `MyCRLTrustInterceptor`, will intercept all incoming request messages directed at the current endpoint.
3. The `asec:crlTrustInterceptor` element defines the bean that is referenced from the `jaxws:inInterceptors` element.
4. The `file` attribute of the `asec:crls` element is used to specify the location of the CRL file.

**Configuring certificate revocation—C++ runtime**

[Example 40](#) shows how to configure a C++ runtime application to use a CRL file. For an application that uses the `secure_artix.my_secure_app` configuration scope, add `cert_validator` to the list of ORB plug-ins and set the `plugins:cert_validator:crl_file_path` variable to the location of the CRL file.

**Example 40:** Configuration of a CRL—C++ Runtime

```
# Artix Configuration File
secure_artix {
  ...
  my_secure_app {
    orb_plugins = [ ... , "cert_validator"];
    plugins:cert_validator:crl_file_path = "CRLDir/crl.pem";
  };
};
```

**Note:** The specified CRL file can be empty, but it must exist. Otherwise, every certificate would be rejected.

**Format of the CRL file**

The CRL file must be in a PEM format.

---

**Sources of CRL files**

You can obtain a CRL file from one of the following sources:

- [Commercial CAs.](#)
  - [OpenSSL CA.](#)
- 

**Commercial CAs**

If you use a commercial CA to manage your certificates, simply ask the CA to generate the CRL file for you.

It is unlikely, however, that the CA will provide the CRL file in the requisite PEM format (the PEM format is proprietary to the OpenSSL product). To convert a CRL file, `crl.der`, from DER format to PEM format, use the following `openssl` command:

```
openssl crl -inform DER -outform PEM -in crl.der -out crl.pem
```

Where `crl.pem` is the converted PEM format file.

---

**OpenSSL CA**

If you use the OpenSSL product to manage a custom CA, you can generate a CRL file by following the instructions in [“Generating a Certificate Revocation List” on page 191.](#)

---

**Creating an aggregate CRL file**

If you need to revoke certificates from more than one CA, you can create an aggregate CRL file simply by concatenating the CRL files from each CA.

For example, if you have a CRL file generated by a commercial CA, `commercial_crl.pem`, and another CRL file generated by a home-grown OpenSSL CA, `openssl_crl.pem`, you can combine these into a single CRL file as follows:

**Windows**

```
copy commercial_crl.pem + openssl_crl.pem crl.pem
```

**UNIX**

```
cat commercial_crl.pem openssl_crl.pem > crl.pem
```

---

# Advanced Configuration Options

---

## Overview

For added security, the HTTPS and IIOp/TLS transports (C++ runtime) allow you to apply extra conditions on certificates. Before reading this section you might find it helpful to consult [“Managing Certificates” on page 171](#), which provides some background information on the structure of certificates.

## In this section

This section discusses the following advanced IIOp/TLS configuration options:

<a href="#">Setting a Maximum Certificate Chain Length—C++ Runtime</a> <a href="#">page 229</a>
<a href="#">Applying Constraints to Certificates—C++ Runtime</a> <a href="#">page 230</a>

---

## Setting a Maximum Certificate Chain Length—C++ Runtime

---

### Max chain length policy

You can use the maximum chain length policy to enforce the maximum length of certificate chains presented by a peer during handshaking.

A certificate chain is made up of a root CA at the top, an application certificate at the bottom and any number of CA intermediaries in between. The length that this policy applies to is the (inclusive) length of the chain from the application certificate presented to the first signer in the chain that appears in the list of trusted CA's (as specified in the `TrustedCAListPolicy`).

---

### Example

For example, a chain length of 2 mandates that the certificate of the immediate signer of the peer application certificate presented must appear in the list of trusted CA certificates.

---

### Configuration variable

You can specify the maximum length of certificate chains used in maximum chain length policy with the `policies:iioptls:max_chain_length_policy` and `policies:max_chain_length_policy` configuration variable. For example:

```
policies:iioptls:max_chain_length_policy = "4";
```

---

### Default value

The default value is 2 (that is, the application certificate and its signer, where the signer must appear in the list of trusted CA's).

---

## Applying Constraints to Certificates—C++ Runtime

---

**Certificate constraints policy**

You can use the certificate constraints policy to apply constraints to peer X.509 certificates. These conditions are applied to the owner's distinguished name (DN) on the first certificate (peer certificate) of the received certificate chain. Distinguished names are made up of a number of distinct fields, the most common being Organization Unit (OU) and Common Name (CN).

**Configuration variable**

You can specify a list of constraints to be used by the certificate constraints policy through the `policies:iiop_tls:certificate_constraints_policy` or `policies:certificate_constraints_policy` configuration variable. For example:

```
policies:iiop_tls:certificate_constraints_policy =
    ["CN=Johnny*,OU=[unit1|IT_SSL],O=IONA,C=Ireland,ST=Dublin,L=Earth",
     "CN=Paul*,OU=SSLTEAM,O=IONA,C=Ireland,ST=Dublin,L=Earth",
     "CN=TheOmnipotentOne"];
```

**Constraint language**

These are the special characters and their meanings in the constraint list:

*	Matches any text. For example: an* matches ant and anger, but not aunt
[ ]	Grouping symbols.
	Choice symbol. For example: OU=[unit1 IT_SSL] signifies that if the OU is unit1 or IT_SSL, the certificate is acceptable.
=, !=	Signify equality and inequality respectively.

**Example**

This is an example list of constraints:

```
policies:iiop_tls:certificate_constraints_policy = [  
    "OU=[unit1|IT_SSL],CN=Steve*,L=Dublin",  
    "OU=IT_ART*,OU!=IT_ARTtesters,CN=[Jan|Donal],ST=  
    Boston" ];
```

This constraint list specifies that a certificate is deemed acceptable if and only if it satisfies one or more of the constraint patterns:

```
If  
    The OU is unit1 or IT_SSL  
    And  
    The CN begins with the text Steve  
    And  
    The location is Dublin  
Then the certificate is acceptable  
Else (moving on to the second constraint)  
If  
    The OU begins with the text IT_ART but isn't IT_ARTtesters  
    And  
    The common name is either Donal or Jan  
    And  
    The State is Boston  
Then the certificate is acceptable  
Otherwise the certificate is unacceptable.
```

The language is like a boolean OR, trying the constraints defined in each line until the certificate satisfies one of the constraints. Only if the certificate fails all constraints is the certificate deemed invalid.

Note that this setting can be sensitive about white space used within it. For example, "CN =" might not be recognized, where "CN=" is recognized.

**Distinguished names**

For more information on distinguished names, see [“ASN.1 and Distinguished Names” on page 731](#).





# Configuring HTTPS Cipher Suites—Java Runtime

*This chapter explains how to specify the list of cipher suites that are made available to client or server program for the purpose of establishing HTTPS (Java runtime) connections. During a security handshake, the client chooses a cipher suite that matches one of the cipher suites available to the server.*

## In this chapter

---

This chapter discusses the following topics:

<a href="#">Supported Cipher Suites</a>	<a href="#">page 234</a>
<a href="#">Cipher Suite Filters</a>	<a href="#">page 236</a>
<a href="#">SSL/TLS Protocol Version</a>	<a href="#">page 239</a>

---

# Supported Cipher Suites

---

## Overview

A *cipher suite* is a collection of security algorithms that determine precisely how an SSL/TLS connection is implemented.

For example, the SSL/TLS protocol mandates that messages be signed using a message digest algorithm. The choice of digest algorithm, however, is determined by the particular cipher suite being used for the connection. Typically, an application can choose either the MD5 or the SHA digest algorithm.

The cipher suites available for SSL/TLS security in the Artix Java runtime depend on the particular *JSSE provider* that is specified on the endpoint.

---

## JCE/JSSE and security providers

The Java Cryptography Extension (JCE) and the Java Secure Socket Extension (JSSE) constitute a pluggable framework that allows you to replace the Java security implementation with arbitrary third-party toolkits, known as *security providers*.

---

## SunJSSE provider

In practice, the security features of the Artix Java runtime have been tested only with SUN's JSSE provider, which is named `SunJSSE`.

Hence, the SSL/TLS implementation and the list of available cipher suites in the Artix Java runtime are effectively determined by what is available from SUN's JSSE provider.

---

## Cipher suites supported by SunJSSE

The following cipher suites are supported by SUN's JSSE provider in the J2SE 1.5.0 Java development kit (see also [Appendix A](#) of SUN's *JSSE Reference Guide*):

- Null encryption, integrity-only ciphers:

```
SSL_RSA_WITH_NULL_MD5
SSL_RSA_WITH_NULL_SHA
```

- Standard ciphers:

```
SSL_DHE_DSS_EXPORT_WITH_DES40_CBC_SHA
SSL_DHE_DSS_WITH_3DES_EDE_CBC_SHA
SSL_DHE_DSS_WITH_DES_CBC_SHA
SSL_DHE_RSA_EXPORT_WITH_DES40_CBC_SHA
SSL_DHE_RSA_WITH_3DES_EDE_CBC_SHA
```

```

SSL_DHE_RSA_WITH_DES_CBC_SHA
SSL_DH_anon_EXPORT_WITH_DES40_CBC_SHA
SSL_DH_anon_EXPORT_WITH_RC4_40_MD5
SSL_DH_anon_WITH_3DES_EDE_CBC_SHA
SSL_DH_anon_WITH_DES_CBC_SHA
SSL_DH_anon_WITH_RC4_128_MD5
SSL_RSA_EXPORT_WITH_DES40_CBC_SHA
SSL_RSA_EXPORT_WITH_RC4_40_MD5
SSL_RSA_WITH_3DES_EDE_CBC_SHA
SSL_RSA_WITH_DES_CBC_SHA
SSL_RSA_WITH_RC4_128_MD5
SSL_RSA_WITH_RC4_128_SHA
TLS_DHE_DSS_WITH_AES_128_CBC_SHA
TLS_DHE_DSS_WITH_AES_256_CBC_SHA
TLS_DHE_RSA_WITH_AES_128_CBC_SHA
TLS_DHE_RSA_WITH_AES_256_CBC_SHA
TLS_DH_anon_WITH_AES_128_CBC_SHA
TLS_DH_anon_WITH_AES_256_CBC_SHA
TLS_KRB5_EXPORT_WITH_DES_CBC_40_MD5
TLS_KRB5_EXPORT_WITH_DES_CBC_40_SHA
TLS_KRB5_EXPORT_WITH_RC4_40_MD5
TLS_KRB5_EXPORT_WITH_RC4_40_SHA
TLS_KRB5_WITH_3DES_EDE_CBC_MD5
TLS_KRB5_WITH_3DES_EDE_CBC_SHA
TLS_KRB5_WITH_DES_CBC_MD5
TLS_KRB5_WITH_DES_CBC_SHA
TLS_KRB5_WITH_RC4_128_MD5
TLS_KRB5_WITH_RC4_128_SHA
TLS_RSA_WITH_AES_128_CBC_SHA
TLS_RSA_WITH_AES_256_CBC_SHA

```

---

## JSSE reference guide

For more information about SUN's JSSE framework, please consult the *JSSE Reference Guide* at the following location:

<http://java.sun.com/j2se/1.5.0/docs/guide/security/jsse/JSSERefGuide.htm>

# Cipher Suite Filters

## Overview

In a typical application, you would usually want to restrict the list of available cipher suites to a subset of the ciphers supported by the JSSE provider.

## Namespaces

[Table 1](#) shows the XML namespaces that are referenced in this section:

**Table 1:** *Namespaces Used for Configuring Cipher Suite Filters*

Prefix	Namespace URI
http	http://cxf.apache.org/transports/http/configuration
httpj	http://cxf.apache.org/transports/http-jetty/configuration
sec	http://cxf.apache.org/configuration/security

## sec:cipherSuitesFilter element

You define a cipher suite filter using the `sec:cipherSuitesFilter` element, which can be inserted either inside a `http:tlsClientParameters` element or inside a `httpj:tlsServerParameters` element. A typical `sec:cipherSuitesFilter` element has the outline structure shown in [Example 41](#).

**Example 41:** *Structure of a sec:cipherSuitesFilter Element*

```
<sec:cipherSuitesFilter>
  <sec:include>RegularExpression</sec:include>
  <sec:include>RegularExpression</sec:include>
  ...
  <sec:exclude>RegularExpression</sec:exclude>
  <sec:exclude>RegularExpression</sec:exclude>
  ...
</sec:cipherSuitesFilter>
```

## Semantics

The following semantic rules apply to the `sec:cipherSuitesFilter` element:

1. If a `sec:cipherSuitesFilter` element does *not* appear in an endpoint's configuration (that is, it is absent from the relevant `http:conduit` or `httpj:engine-factory` element), the following default filter is used:

```
<sec:cipherSuitesFilter>
  <sec:include>.*_EXPORT_.*</sec:include>
  <sec:include>.*_EXPORT1024_.*</sec:include>
  <sec:include>.*_DES_.*</sec:include>
  <sec:include>.*_WITH_NULL_.*</sec:include>
</sec:cipherSuitesFilter>
```

2. If the `sec:cipherSuitesFilter` element *does* appear in an endpoint's configuration, all cipher suites are *excluded* by default.
3. To include cipher suites, add a `sec:include` element to the `sec:cipherSuitesFilter` element. The content of the `sec:include` element is a regular expression that matches one or more cipher suite names (for example, see the cipher suite names in [“Cipher suites supported by SunJSSE” on page 234](#)).
4. To refine the selected set of cipher suites further, you can add a `sec:exclude` element to the `sec:cipherSuitesFilter` element. The content of the `sec:exclude` element is a regular expression that matches zero or more cipher suite names from the currently included set.

**Note:** Sometimes it makes sense to explicitly exclude cipher suites that are currently not included, in order to future-proof against accidental inclusion of undesired cipher suites.

## Regular expression matching

The grammar for the regular expressions that appear in the `sec:include` and `sec:exclude` elements is defined by the Java regular expression utility, `java.util.regex.Pattern`. For a detailed description of the grammar, please consult the Java reference guide, <http://java.sun.com/j2se/1.5.0/docs/api/java/util/regex/Pattern.html>.

### Client conduit example

The following XML configuration shows an example of a client that applies a cipher suite filter to the remote endpoint, `{WSDLPortNamespace}PortName`. Whenever the client attempts to open an SSL/TLS connection to this endpoint, it restricts the available cipher suites to the set selected by the `sec:cipherSuitesFilter` element.

```
<beans ... >
  <http:conduit name="{WSDLPortNamespace}PortName.http-conduit">
    <http:tlsClientParameters>
      ...
      <sec:cipherSuitesFilter>
        <sec:include>.*_WITH_3DES_.*</sec:include>
        <sec:include>.*_WITH_DES_.*</sec:include>
        <sec:exclude>.*_WITH_NULL_.*</sec:exclude>
        <sec:exclude>.*_DH_anon_.*</sec:exclude>
      </sec:cipherSuitesFilter>
    </http:tlsClientParameters>
  </http:conduit>

  <bean id="cxf" class="org.apache.cxf.bus.CXFBusImpl"/>
</beans>
```

---

# SSL/TLS Protocol Version

---

## Overview

The versions of the SSL/TLS protocol that are supported by the Artix Java runtime depend on the particular *JSSE provider* configured. By default, the JSSE provider is configured to be SUN's JSSE provider implementation.

## SSL/TLS protocol versions supported by SunJSSE

[Table 2](#) shows the SSL/TLS protocol versions supported by SUN's JSSE provider.

**Table 2:** *SSL/TLS Protocols Supported by SUN's JSSE Provider*

Protocol	Description
SSL	Supports some version of SSL; may support other versions
SSLv2	Supports SSL version 2 or higher
SSLv3	Supports SSL version 3; may support other versions
TLS	Supports some version of TLS; may support other versions
TLSv1	Supports TLS version 1; may support other versions

### Specifying the SSL/TLS protocol version

You can specify the preferred SSL/TLS protocol version as an attribute on the `http:tlsClientParameters` element (client side) or on the `httpj:tlsServerParameters` element (server side).

#### Client side SSL/TLS protocol version

You can specify the protocol to be TLS on the client side by setting the `secureSocketProtocol` attribute as follows:

```
<?xml version="1.0" encoding="UTF-8"?>
<beans ... >
  ...
  <http:conduit name="{Namespace}PortName.http-conduit">
    ...
    <http:tlsClientParameters secureSocketProtocol="TLS">
      ...
    </http:tlsClientParameters>
  </http:conduit>
  ...
</beans>
```

#### Server side SSL/TLS protocol version

You can specify the protocol to be TLS on the server side by setting the `secureSocketProtocol` attribute as follows:

```
<?xml version="1.0" encoding="UTF-8"?>
<beans ... >
  ...
  <httpj:engine-factory bus="cxf">
    <httpj:engine port="9001">
      ...
      <httpj:tlsServerParameters secureSocketProtocol="TLS">
        ...
      </httpj:tlsServerParameters>
    </httpj:engine>
  </httpj:engine-factory>
  ...
</beans>
```



# Configuring Secure Associations

*The Artix HTTPS (C++ runtime) and IIOP/TLS (C++ runtime and Java runtime) transport layers offer additional functionality that enables you to customize client-server connections by specifying secure invocation policies and security mechanism policies.*

## In this chapter

---

This chapter discusses the following topics:

<a href="#">Overview of Secure Associations</a>	<a href="#">page 242</a>
<a href="#">Setting Association Options</a>	<a href="#">page 244</a>
<a href="#">Specifying Cipher Suites</a>	<a href="#">page 257</a>
<a href="#">Caching Sessions</a>	<a href="#">page 267</a>

---

# Overview of Secure Associations

---

## Secure association

A *secure association* is a term that has its origins in the CORBA Security Service and refers to any link between a client and a server that enables invocations to be transmitted securely. In the present context, a secure association is a HTTPS connection or an IIOP/TLS connection augmented by a collection of security policies that govern the behavior of the connection.

---

## TLS session

A *TLS session* is the TLS implementation of a secure client-server association. The TLS session is accompanied by a *session state* that stores the security characteristics of the association.

A TLS session underlies each secure association in Artix.

---

## Colocation

For *colocated invocations*, that is where the calling code and called code share the same address space, Artix supports the establishment of colocated secure associations. A special interceptor, `TLS_Coloc`, is provided by the security plug-in to optimize the transmission of secure, colocated invocations.

---

## Configuration overview

The security characteristics of an association can be configured through the following CORBA policy types:

- *Client secure invocation policy*—enables you to specify the security requirements on the client side by setting association options. See [“Choosing Client Behavior” on page 249](#) for details.
- *Target secure invocation policy*—enables you to specify the security requirements on the server side by setting association options. See [“Choosing Target Behavior” on page 251](#) for details.
- *Mechanism policy*—enables you to specify the security mechanism used by secure associations. In the case of TLS, you are required to specify a list of cipher suites for your application. See [“Specifying Cipher Suites” on page 257](#) for details.

Figure 28 illustrates all of the elements that configure a secure association. The security characteristics of the client and the server can be configured independently of each other.

Figure 28: Configuration of a Secure Association

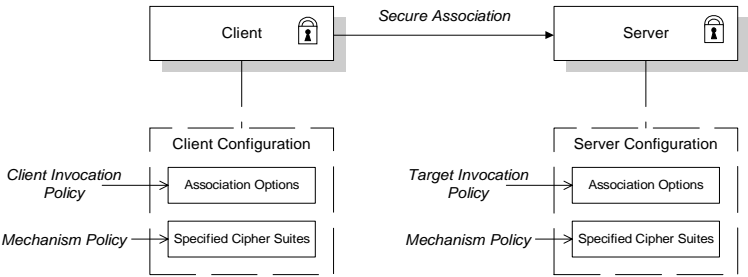

---

# Setting Association Options

---

**Overview**

This section explains the meaning of the various association options and describes how you can use the association options to set client and server secure invocation policies for HTTPS (C++ runtime) and IIOP/TLS (C++ runtime and Java runtime) connections.

---

**In this section**

The following subsections discuss the meaning of the settings and flags:

<a href="#">Secure Invocation Policies</a>	<a href="#">page 245</a>
<a href="#">Association Options</a>	<a href="#">page 247</a>
<a href="#">Choosing Client Behavior</a>	<a href="#">page 249</a>
<a href="#">Choosing Target Behavior</a>	<a href="#">page 251</a>
<a href="#">Hints for Setting Association Options</a>	<a href="#">page 253</a>

---

## Secure Invocation Policies

---

### Secure invocation policies

You can set the minimum security requirements for the applications in your system with two types of security policy:

- *Client secure invocation policy*—specifies the client association options.
- *Target secure invocation policy*—specifies the association options on a target object.

These policies can only be set through configuration; they cannot be specified programmatically by security-aware applications.

---

### IIOPTLS configuration example

For example, to specify that client authentication is required for IIOPTLS connections, you can set the following target secure invocation policy for your server:

```
# Artix Configuration File
secure_server_enforce_client_auth
{
  # IIOPTLS Association Options
  policies:iioptls:target_secure_invocation_policy:requires =
  ["EstablishTrustInClient", "Confidentiality", "Integrity",
  "DetectReplay", "DetectMisordering"];

  policies:iioptls:target_secure_invocation_policy:supports =
  ["EstablishTrustInClient", "Confidentiality", "Integrity",
  "DetectReplay", "DetectMisordering",
  "EstablishTrustInTarget"];

  # Other settings (not shown)...
};
```

**Note:** If using the Java runtime, you must first associate the server with a configuration file—see [“Configuring the Java Runtime CORBA Binding” on page 765](#) for details.

**HTTPS configuration example**

For example, to specify that client authentication is required for HTTPS connections, you can set the following target secure invocation policy for your server:

```
# Artix Configuration File
secure_server_enforce_client_auth
{
  # HTTPS Association Options
  policies:target_secure_invocation_policy:requires =
  ["EstablishTrustInClient", "Confidentiality", "Integrity",
  "DetectReplay", "DetectMisordering"];

  policies:target_secure_invocation_policy:supports =
  ["EstablishTrustInClient", "Confidentiality", "Integrity",
  "DetectReplay", "DetectMisordering",
  "EstablishTrustInTarget"];

  # Other settings (not shown)...
};
```

---

## Association Options

---

### Available options

You can use *association options* to configure IOP/TLS secure associations. They can be set for clients or servers where appropriate. These are the available options:

- `NoProtection`
  - `Integrity`
  - `Confidentiality`
  - `DetectReplay`
  - `DetectMisordering`
  - `EstablishTrustInTarget`
  - `EstablishTrustInClient`
- 

### NoProtection

Use the `NoProtection` flag to set minimal protection. This means that insecure bindings are supported, and (if the application supports something other than `NoProtection`) the target can accept secure and insecure invocations.

---

### Integrity

Use the `Integrity` flag to indicate that your application supports integrity-protected invocations. Setting this flag implies that your TLS cipher suites support message digests (such as MD5, SHA1).

---

### Confidentiality

Use the `Confidentiality` flag if your application requires or supports at least confidentiality-protected invocations. The object can support this feature if the cipher suites specified by the `MechanismPolicy` support confidentiality-protected invocations.

---

### DetectReplay

Use the `DetectReplay` flag to indicate that your application supports or requires replay detection on invocation messages. This is determined by characteristics of the supported TLS cipher suites.

---

### DetectMisordering

Use the `DetectMisordering` flag to indicate that your application supports or requires error detection on fragments of invocation messages. This is determined by characteristics of the supported TLS cipher suites.

---

**EstablishTrustInTarget**

The `EstablishTrustInTarget` flag is set for client policies only. Use the flag to indicate that your client supports or requires that the target authenticate its identity to the client. This is determined by characteristics of the supported TLS cipher suites. This is normally set for both `client supports` and `requires` unless anonymous cipher suites are supported.

---

**EstablishTrustInClient**

Use the `EstablishTrustInClient` flag to indicate that your target object requires the client to authenticate its privileges to the target. This option cannot be required as a client policy.

If this option is supported on a client's policy, it means that the client is prepared to authenticate its privileges to the target. On a target policy, the target supports having the client authenticate its privileges to the target.



---

## Choosing Client Behavior

---

### Client secure invocation policy

The client secure invocation policy type determines how a client handles security issues.

---

### IIOPTLS configuration

You can set this policy for IIOPTLS connections (C++ runtime and Java runtime) through the following configuration variables:

`policies:iioptls:client_secure_invocation_policy:requires`  
Specifies the minimum security features that the client requires to establish an IIOPTLS connection.

`policies:iioptls:client_secure_invocation_policy:supports`  
Specifies the security features that the client is able to support on IIOPTLS connections.

**Note:** If using the Java runtime, you must first associate the client with a configuration file—see [“Configuring the Java Runtime CORBA Binding” on page 765](#) for details.

---

### HTTPS configuration

You can set this policy for HTTPS connections (C++ runtime) through the following generic configuration variables:

`policies:client_secure_invocation_policy:requires`  
Specifies the minimum security features that the client requires to establish a HTTPS connection or an IIOPTLS connection.

`policies:client_secure_invocation_policy:supports`  
Specifies the security features that the client is able to support on HTTPS connections and IIOPTLS connections.

---

### Association options

In both cases, you provide the details of the security levels in the form of `AssociationOption` flags—see [“Association Options” on page 247](#).

**Default value**

---

The default value for the client secure invocation policy is:

supports	Integrity, Confidentiality, DetectReplay, DetectMisordering, EstablishTrustInTarget
requires	Integrity, Confidentiality, DetectReplay, DetectMisordering, EstablishTrustInTarget

---

**Example**

The following example shows some sample settings for the client secure invocation policy:

```
# Artix Configuration File
bank_client {
  ...
  policies:iop_tls:client_secure_invocation_policy:requires =
    ["Confidentiality", "Integrity", "DetectReplay",
    "DetectMisordering", "EstablishTrustInTarget"];

  policies:iop_tls:client_secure_invocation_policy:supports =
    ["Confidentiality", "Integrity", "DetectReplay",
    "DetectMisordering", "EstablishTrustInTarget"];
};
...
};
```

---

## Choosing Target Behavior

---

### Target secure invocation policy

The target secure invocation policy type operates in a similar way to the client secure invocation policy type. It determines how a target handles security issues.

---

### IIOPTLS configuration

You can set the target secure invocation policy for IIOPTLS connections (C++ runtime and Java runtime) through the following configuration variables:

`policies:iioptls:target_secure_invocation_policy:requires`  
Specifies the minimum security features that your targets require, before they accept an IIOPTLS connection.

`policies:iioptls:target_secure_invocation_policy:supports`  
Specifies the security features that your targets are able to support on IIOPTLS connections.

**Note:** If using the Java runtime, you must first associate the server with a configuration file—see [“Configuring the Java Runtime CORBA Binding” on page 765](#) for details.

---

### HTTPS configuration

You can set the target secure invocation policy for HTTPS connections (C++ runtime) through the following configuration variables:

`policies:target_secure_invocation_policy:requires`  
Specifies the minimum security features that your targets require, before they accept a HTTPS connection.

`policies:target_secure_invocation_policy:supports`  
Specifies the security features that your targets are able to support on HTTPS connections.

---

### Association options

In both cases, you can provide the details of the security levels in the form of `AssociationOption` flags—see [“Association Options” on page 247](#).

**Default value for IIOP/TLS**

---

The default value for the IIOP/TLS target secure invocation policy is:

```
supports      Integrity, Confidentiality, DetectReplay,
              DetectMisordering, EstablishTrustInTarget
requires      Integrity, Confidentiality, DetectReplay,
              DetectMisordering
```

---

**Default value for HTTPS**

The default value for the HTTPS target secure invocation policy is:

```
supports      Integrity, Confidentiality, DetectReplay,
              DetectMisordering, EstablishTrustInTarget,
              EstablishTrustInClient
requires      Integrity, Confidentiality, DetectReplay,
              DetectMisordering, EstablishTrustInClient
```

In contrast to the IIOP/TLS policy, the HTTPS policy additionally requires `EstablishTrustInClient` by default.

---

**Example**

The following example shows some sample settings for the target secure invocation policy:

```
# Artix Configuration File
...
bank_server {
  ...
  policies:iiop_tls:target_secure_invocation_policy:requires =
    ["Confidentiality", "Integrity", "DetectReplay",
    "DetectMisordering"];

  policies:iiop_tls:target_secure_invocation_policy:supports =
    ["Confidentiality", "Integrity", "DetectReplay",
    "DetectMisordering", "EstablishTrustInTarget"];
  ...
};
...
```

---

## Hints for Setting Association Options

---

### Overview

This section gives an overview of how association options can be used in real applications.

---

### Rules of thumb

The following rules of thumb should be kept in mind:

- If an association option is *required* by a particular invocation policy, it must also be *supported* by that invocation policy. It makes no sense to require an association option without supporting it.
  - It is important to be aware that the secure invocation policies and the security mechanism policy mutually interact with each other. That is, the association options effective for a particular secure association depend on the available cipher suites (see [“Constraints Imposed on Cipher Suites” on page 264](#)).
  - The `NoProtection` option must appear alone in a list of *required* options. It does not make sense to require other security options in addition to `NoProtection`.
- 

### Types of association option

Association options can be categorized into the following different types, as shown in [Table 3](#).

**Table 3:** *Description of Different Types of Association Option*

Description	Relevant Association Options
Request or require TLS peer authentication.	<a href="#">EstablishTrustInTarget</a> and <a href="#">EstablishTrustInClient</a> .
Quality of protection.	<a href="#">Confidentiality</a> , <a href="#">Integrity</a> , <a href="#">DetectReplay</a> , and <a href="#">DetectMisordering</a> .
Allow or require insecure connections.	<a href="#">NoProtection</a> .

## EstablishTrustInTarget and EstablishTrustInClient

These association options are used as follows:

- `EstablishTrustInTarget`—determines whether a server sends its own X.509 certificate to a client during the SSL/TLS handshake. In practice, secure Artix applications must enable `EstablishTrustInTarget`, because all of the cipher suites supported by Artix require it.

The `EstablishTrustInTarget` association option should appear in all of the configuration variables shown in the relevant row of [Table 4](#).

- `EstablishTrustInClient`—determines whether a client sends its own X.509 certificate to a server during the SSL/TLS handshake. The `EstablishTrustInClient` feature is optional and various combinations of settings are possible involving this association option.

The `EstablishTrustInClient` association option can appear in any of the configuration variables shown in the relevant row of [Table 4](#).

**Table 4:** *Setting EstablishTrustInTarget and EstablishTrustInClient Association Options*

Association Option	Client side—can appear in...	Server side—can appear in...
<code>EstablishTrustInTarget</code>	<code>policies:client_secure_invocation_policy:supports</code> <code>policies:client_secure_invocation_policy:requires</code>	<code>policies:target_secure_invocation_policy:supports</code>
<code>EstablishTrustInClient</code>	<code>policies:client_secure_invocation_policy:supports</code>	<code>policies:target_secure_invocation_policy:supports</code> <code>policies:target_secure_invocation_policy:requires</code>

**Note:** The SSL/TLS client authentication step can also be affected by the `policies:allow_unauthenticated_clients_policy` configuration variable. See “[policies](#)” on page 648.

**Confidentiality, Integrity, DetectReplay, and DetectMisordering**

These association options can be considered together, because normally you would require either all or none of these options. Most of the cipher suites supported by Orbix support all of these association options, although there are a couple of integrity-only ciphers that do not support `Confidentiality` (see [Table 8 on page 265](#)). As a rule of thumb, if you want security you generally would want *all* of these association options.

**Table 5:** *Setting Quality of Protection Association Options*

Association Options	Client side—can appear in...	Server side—can appear in...
Confidentiality, Integrity, DetectReplay, and DetectMisordering	<code>policies:client_secure_invocation_policy:supports</code>	<code>policies:target_secure_invocation_policy:supports</code>
	<code>policies:client_secure_invocation_policy:requires</code>	<code>policies:target_secure_invocation_policy:requires</code>

A typical secure application would list *all* of these association options in *all* of the configuration variables shown in [Table 5](#).

**Note:** Some of the sample configurations appearing in the generated configuration file require `Confidentiality`, but not the other qualities of protection. In practice, however, the list of required association options is implicitly extended to include the other qualities of protection, because the cipher suites that support `Confidentiality` also support the other qualities of protection. This is an example of where the security mechanism policy interacts with the secure invocation policies.

**NoProtection**

The `NoProtection` association option is used for two distinct purposes:

- *Disabling security selectively*—security is disabled, either in the client role or in the server role, if `NoProtection` appears as the sole *required* association option and as the sole *supported* association option in a secure invocation policy. This mechanism is selective in the sense that the client role and the server role can be independently configured as either secure or insecure.

**Note:** In this case, the `orb_plugins` configuration variable should include the `iiop` plug-in to enable insecure IIOP communication.

- *Making an application semi-secure*—an application is semi-secure, either in the client role or in the server role, if `NoProtection` appears as the sole *required* association option and as a *supported* association option along with other secure association options. The meaning of semi-secure in this context is, as follows:
  - ◆ *Semi-secure client*—the client will open either a secure or an insecure connection, depending on the disposition of the server (that is, depending on whether the server accepts only secure connections or only insecure connections). If the server is semi-secure, the type of connection opened depends on the order of the bindings in the `binding:client_binding_list`.
  - ◆ *Semi-secure server*—the server accepts connections either from a secure or an insecure client.

**Note:** In the case of a semi-secure CORBA server, the `orb_plugins` configuration variable should include both the `iiop_tls` plug-in and the `iiop` plug-in.

Table 6 shows the configuration variables in which the `NoProtection` association option can appear.

**Table 6:** *Setting the NoProtection Association Option*

Association Option	Client side—can appear in...	Server side—can appear in...
NoProtection	<p><code>policies:client_secure_invocation_policy:supports</code></p> <p><code>policies:client_secure_invocation_policy:requires</code></p>	<p><code>policies:target_secure_invocation_policy:supports</code></p> <p><code>policies:target_secure_invocation_policy:requires</code></p>



---

# Specifying Cipher Suites

## Overview

---

This section explains how to specify the list of cipher suites that are made available to an application (client or server) for the purpose of establishing IIOP/TLS (C++ runtime or Java runtime) and HTTPS (C++ runtime) secure associations. During a security handshake, the client chooses a cipher suite that matches one of the cipher suites available to the server. The cipher suite then determines the security algorithms that are used for the secure association.

## In this section

---

This section contains the following subsections:

<a href="#">Supported Cipher Suites</a>	<a href="#">page 258</a>
<a href="#">Setting the Mechanism Policy</a>	<a href="#">page 261</a>
<a href="#">Constraints Imposed on Cipher Suites</a>	<a href="#">page 264</a>

---

## Supported Cipher Suites

---

### Artix cipher suites

The following cipher suites are supported by IIOP/TLS and HTTPS, which are both implemented using the Baltimore security toolkit:

- Null encryption, integrity-only ciphers:

```
RSA_WITH_NULL_MD5
RSA_WITH_NULL_SHA
```

- Standard ciphers

```
RSA_EXPORT_WITH_RC4_40_MD5
RSA_WITH_RC4_128_MD5
RSA_WITH_RC4_128_SHA
RSA_EXPORT_WITH_DES40_CBC_SHA
RSA_WITH_DES_CBC_SHA
RSA_WITH_3DES_EDE_CBC_SHA
```

---

### Security algorithms

Each cipher suite specifies a set of three security algorithms, which are used at various stages during the lifetime of a secure association:

- *Key exchange algorithm*—used during the security handshake to enable authentication and the exchange of a symmetric key for subsequent communication. Must be a public key algorithm.
  - *Encryption algorithm*—used for the encryption of messages after the secure association has been established. Must be a symmetric (private key) encryption algorithm.
  - *Secure hash algorithm*—used for generating digital signatures. This algorithm is needed to guarantee message integrity.
- 

### Key exchange algorithms

The following key exchange algorithms are supported:

RSA	Rivest Shamir Adleman (RSA) public key encryption using X.509v3 certificates. No restriction on the key size.
RSA_EXPORT	RSA public key encryption using X.509v3 certificates. Key size restricted to 512 bits.

**Encryption algorithms**

The following encryption algorithms are supported:

RC4_40	A symmetric encryption algorithm developed by RSA data security. Key size restricted to 40 bits.
RC4_128	RC4 with a 128-bit key.
DES40_CBC	Data encryption standard (DES) symmetric encryption. Key size restricted to 40 bits.
DES_CBC	DES with a 56-bit key.
3DES_EDE_CBC	Triple DES (encrypt, decrypt, encrypt) with an effective key size of 168 bits.

**Secure hash algorithms**

The following secure hash algorithms are supported:

MD5	Message Digest 5 (MD5) hash algorithm. This algorithm produces a 128-bit digest.
SHA	Secure hash algorithm (SHA). This algorithm produces a 160-bit digest, but is somewhat slower than MD5.

**Cipher suite definitions**

The Baltimore-based cipher suites in Artix are defined as follows:

**Table 7:** *Cipher Suite Definitions*

Cipher Suite	Key Exchange Algorithm	Encryption Algorithm	Secure Hash Algorithm	Exportable?
RSA_WITH_NULL_MD5	RSA	NULL	MD5	yes
RSA_WITH_NULL_SHA	RSA	NULL	SHA	yes
RSA_EXPORT_WITH_RC4_40_MD5	RSA_EXPORT	RC4_40	MD5	yes
RSA_WITH_RC4_128_MD5	RSA	RC4_128	MD5	no
RSA_WITH_RC4_128_SHA	RSA	RC4_128	SHA	no
RSA_EXPORT_WITH_DES40_CBC_SHA	RSA_EXPORT	DES40_CBC	SHA	yes
RSA_WITH_DES_CBC_SHA	RSA	DES_CBC	SHA	no
RSA_WITH_3DES_EDE_CBC_SHA	RSA	3DES_EDE_CBC	SHA	no

---

**Reference**

For further details about cipher suites in the context of TLS, see RFC 2246 from the Internet Engineering Task Force (IETF). This document is available from the IETF Web site: <http://www.ietf.org>.

---

## Setting the Mechanism Policy

---

### Mechanism policy

To specify IIOP/TLS cipher suites, use the *mechanism policy*. The mechanism policy is a client and server side security policy that determines

- Whether SSL or TLS is used, and
  - Which specific cipher suites are to be used.
- 

### The `protocol_version` configuration variable

You can specify whether SSL, TLS or both are used with a transport protocol by assigning a list of protocol versions to the

`policies:iiop_tls:mechanism_policy:protocol_version` configuration variable for IIOP/TLS and the

`policies:https:mechanism_policy:protocol_version` configuration variable for HTTPS. For example:

```
# Artix Configuration File
policies:iiop_tls:mechanism_policy:protocol_version = ["TLS_V1",
"SSL_V3"];
```

You can set the `protocol_version` configuration variable to include one or more of the following protocols:

```
TLS_V1
SSL_V3
```

The order of the entries in the `protocol_version` list is unimportant. During the SSL/TLS handshake, the highest common protocol will be negotiated.

---

### Interoperating with CORBA applications on OS/390

There are some implementations of SSL/TLS on the OS/390 platform that erroneously send SSL V2 client hellos at the start of an SSL V3 or TLS V1 handshake. If you need to interoperate with a CORBA application running on OS/390, you can configure Artix to accept SSL V2 client hellos using the `policies:iiop_tls:mechanism_policy:accept_v2_hellos` configuration variable for IIOP/TLS. For example:

```
# Artix Configuration File
policies:iiop_tls:mechanism_policy:accept_v2_hellos = "true";
```

The default is `false`.

**The cipher suites configuration variable**

You can specify the cipher suites available to a transport protocol by setting the `policies:iioptls:mechanism_policy:ciphersuites` configuration variable for IIOPTLS and the `policies:https:mechanism_policy:ciphersuites` configuration variable for HTTPS. For example:

```
# Artix Configuration File
policies:iioptls:mechanism_policy:ciphersuites =
  ["RSA_WITH_NULL_MD5",
   "RSA_WITH_NULL_SHA",
   "RSA_EXPORT_WITH_RC4_40_MD5",
   "RSA_WITH_RC4_128_MD5" ];
```

**Cipher suite order**

The order of the entries in the mechanism policy's cipher suites list is important.

During a security handshake, the client sends a list of acceptable cipher suites to the server. The server then chooses the first of these cipher suites that it finds acceptable. The secure association is, therefore, more likely to use those cipher suites that are near the beginning of the `ciphersuites` list.

**Valid cipher suites**

You can specify any of the following cipher suites:

- Null encryption, integrity only ciphers:

```
RSA_WITH_NULL_MD5,
RSA_WITH_NULL_SHA
```

- Standard ciphers

```
RSA_EXPORT_WITH_RC4_40_MD5,
RSA_WITH_RC4_128_MD5,
RSA_WITH_RC4_128_SHA,
RSA_EXPORT_WITH_DES40_CBC_SHA,
RSA_WITH_DES_CBC_SHA,
RSA_WITH_3DES_EDE_CBC_SHA
```

**Default values**

---

If no cipher suites are specified through configuration or application code, the following apply:

```
RSA_WITH_RC4_128_SHA,  
RSA_WITH_RC4_128_MD5,  
RSA_WITH_3DES_EDE_CBC_SHA,  
RSA_WITH_DES_CBC_SHA
```

That is, by default all of the null encryption cipher suites are disabled and all of the non-export cipher suites are supported.

## Constraints Imposed on Cipher Suites

### Effective cipher suites

Figure 29 shows that cipher suites initially specified in the configuration are *not* necessarily made available to the application. Artix checks each cipher suite for compatibility with the specified association options and, if necessary, reduces the size of the list to produce a list of *effective cipher suites*.

**Figure 29:** *Constraining the List of Cipher Suites*

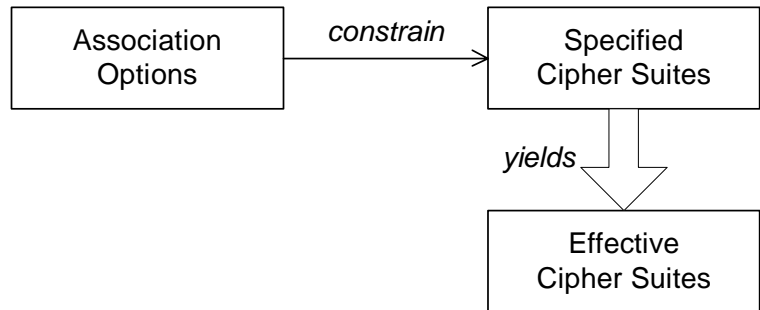

### Required and supported association options

For example, in the context of the IIOP/TLS protocol the list of cipher suites is affected by the following configuration options:

- *Required association options*—as listed in `policies:iiop_tls:client_secure_invocation_policy:requires` on the client side, or `policies:iiop_tls:target_secure_invocation_policy:requires` on the server side.
- *Supported association options*—as listed in `policies:iiop_tls:client_secure_invocation_policy:supports` on the client side, or `policies:iiop_tls:target_secure_invocation_policy:supports` on the server side.



**Cipher suite compatibility table**

Use [Table 8](#) to determine whether or not a particular cipher suite is compatible with your association options.

**Table 8:** *Association Options Supported by Cipher Suites*

Cipher Suite	Supported Association Options
RSA_WITH_NULL_MD5	Integrity, DetectReplay, DetectMisordering
RSA_WITH_NULL_SHA	Integrity, DetectReplay, DetectMisordering
RSA_EXPORT_WITH_RC4_40_MD5	Integrity, DetectReplay, DetectMisordering, Confidentiality
RSA_WITH_RC4_128_MD5	Integrity, DetectReplay, DetectMisordering, Confidentiality
RSA_WITH_RC4_128_SHA	Integrity, DetectReplay, DetectMisordering, Confidentiality
RSA_EXPORT_WITH_DES40_CBC_SHA	Integrity, DetectReplay, DetectMisordering, Confidentiality
RSA_WITH_DES_CBC_SHA	Integrity, DetectReplay, DetectMisordering, Confidentiality
RSA_WITH_3DES_EDE_CBC_SHA	Integrity, DetectReplay, DetectMisordering, Confidentiality

**Determining compatibility**

The following algorithm is applied to the initial list of cipher suites:

1. For the purposes of the algorithm, ignore the `EstablishTrustInClient` and `EstablishTrustInTarget` association options. These options have no effect on the list of cipher suites.
2. From the initial list, remove any cipher suite whose supported association options (see [Table 8](#)) do not satisfy the configured required association options.
3. From the remaining list, remove any cipher suite that supports an option (see [Table 8](#)) not included in the configured supported association options.

---

**No suitable cipher suites available** If no suitable cipher suites are available as a result of incorrect configuration, no communications will be possible and an exception will be raised. Logging also provides more details on what went wrong.

---

**Example** For example, specifying a cipher suite such as `RSA_WITH_RC4_128_MD5` that supports `Confidentiality`, `Integrity`, `DetectReplay`, `DetectMisordering`, `EstablishTrustInTarget` (and optionally `EstablishTrustInClient`) but specifying a `secure_invocation_policy` that supports only a subset of those features results in that cipher suite being ignored.

---

# Caching Sessions

## Session caching policy

You can use the IIOP/TLS (C++ runtime and Java runtime) and HTTPS (C++ runtime) session caching policies to control TLS session caching and reuse for both the client side and the server side.

## Configuration variable

You can set the session caching policy with the `policies:iiop_tls:session_caching_policy` or `policies:session_caching_policy` configuration variables. For example:

```
policies:iiop_tls:session_caching_policy = "CACHE_CLIENT";
```

## Valid values

You can apply the following values to the session caching policy:

```
CACHE_NONE,
CACHE_CLIENT,
CACHE_SERVER,
CACHE_SERVER_AND_CLIENT
```

## Default value

The default value is `CACHE_NONE`.

## Configuration variable

```
plugins:atli_tls_tcp:session_cache_validity_period
```

This allows control over the period of time that SSL/TLS session caches are valid for.

## Valid values

`session_cache_validity_period` is specified in seconds.

## Default value

The default value is 1 day.

## Configuration variable

```
plugins:atli_tls_tcp:session_cache_size
```

`session_cache_size` is the maximum number of SSL/TLS sessions that are cached before sessions are flushed from the cache.

## Default value

This defaults to no limit specified for C++.



# Part III

## The Artix Security Service

---

### In this part

This part contains the following chapters:

<a href="#">Configuring the Artix Security Service</a>	<a href="#">page 271</a>
<a href="#">Managing Users, Roles and Domains</a>	<a href="#">page 335</a>
<a href="#">Managing Access Control Lists</a>	<a href="#">page 351</a>
<a href="#">Configuring Servers to Support Authentication—Java Runtime</a>	<a href="#">page 363</a>
<a href="#">Configuring the Artix Security Plug-In—C++ Runtime</a>	<a href="#">page 379</a>



# Configuring the Artix Security Service

*This chapter describes how to configure the properties of the Artix security service and, in particular, how to configure a variety of adapters that can integrate the Artix security service with third-party enterprise security back-ends (for example, LDAP).*

---

**In this chapter**

This chapter discusses the following topics:

<a href="#">Configuring the Security Service</a>	<a href="#">page 272</a>
<a href="#">Configuring the File Adapter</a>	<a href="#">page 293</a>
<a href="#">Configuring the LDAP Adapter</a>	<a href="#">page 295</a>
<a href="#">Configuring the Kerberos Adapter</a>	<a href="#">page 301</a>
<a href="#">Clustering and Federation</a>	<a href="#">page 313</a>
<a href="#">Additional Security Configuration</a>	<a href="#">page 330</a>

---

# Configuring the Security Service

## Overview

---

To configure the basic properties of the Artix security service, you must edit the appropriate settings in the Artix configuration file. In particular, the settings in the Artix configuration file enable you to specify the manner in which the security service communicates with other Artix programs.

Two major variants of security service communications are supported: IIOPTLS-based and HTTPS-based.

## In this section

---

This section contains the following subsections:

<a href="#">Security Service Accessible through IIOPTLS</a>	<a href="#">page 273</a>
<a href="#">Security Service Accessible through HTTPS</a>	<a href="#">page 282</a>



---

## Security Service Accessible through IIOP/TLS

---

### Overview

This section describes how to configure a security service that is made accessible through the IIOP/TLS protocol. This approach to configuring the security service has been used by all versions of Artix that include security, up to and including 4.0.

---

### Setting the security service's host and port

To change the security service's host and port, edit the configuration as follows:

- *Configuration of the security service*—in the security service's configuration scope, specify the host and port as follows:

```
# Artix Configuration File
plugins:security:iiop_tls:host = "SecurityHost";
plugins:security:iiop_tls:port = "SecurityPort";
```

Where *SecurityHost* and *SecurityPort* specify the host and IP port where the security service listens for IIOP/TLS connections.

Alternatively, you can specify the host and port as follows:

```
# Artix Configuration File
plugins:security:iiop_tls:addr_list =
  ["SecurityHost:SecurityPort"];
```

This configuration setting has the advantage that you can, when necessary, expand the list of IP addresses to support the failover and clustering features—see [“Clustering and Federation” on page 313](#).

- *Configuration of clients of the security service*—for any programs that need to contact the security service, add the following line to their configuration scopes (or enclosing scopes):

```
# Artix Configuration File
corbaloc:it_iiops:1.2@SecurityHost:SecurityPort/IT_Security
  Service
```

Where you must replace the *SecurityHost* and *SecurityPort* settings in the *it\_iiops* address.

---

## Replacing X.509 certificates

The security service is provided with demonstration X.509 certificates by default. Whilst this is convenient for running demonstrations and tests, it is fundamentally insecure, because Artix provides identical demonstration certificates for every installation.

Before deploying the security service in a live system, therefore, you *must* replace the default X.509 certificates with your own custom-generated certificates. Specifically, for the security service you must replace the following certificates:

- *Trusted CA list*—this is a list of trusted Certification Authority (CA) certificates, which is used to vet certificates presented by clients. Only certificates signed by one of the CAs on the trusted list will be allowed to connect to the security service.

To update the trusted CA list, edit the

`policies:trusted_ca_list_policy` variable in the security service's configuration scope (or enclosing scope). For more details, see

[“Specifying Trusted CA Certificates” on page 206](#).

- *Security service's own certificate*—the security service uses its own X.509 certificate to identify itself to peers during SSL/TLS handshakes.

To replace the security service's own certificate, edit the principal sponsor settings in the security service's configuration scope (or enclosing scope). For more details, see [“Specifying an Application's Own Certificate” on page 216](#).

---

## Setting client certificate constraints

To provide a basic level of access control, the security service enables you to set client certificate constraints, which prevents clients from opening a connection to the security service unless they present a certificate that matches the specified constraints.

To specify the security service's client certificate constraints, assign the constraints to the

`policies:security_server:client_certificate_constraints` configuration variable (for details of how to specify constraints, see [“Applying Constraints to Certificates” on page 605](#)).

**Note:** You should specify the security service's constraints using the `policies:security_server:client_certificate_constraints` constraints variable rather than the generic `policies:certificate_constraints_policy` constraints variable. This approach allows you to differentiate between the constraints on the security service and the constraints on other services that might run in the same process (for example, the login service).

---

### Minimum level of security

The security service *always* requires clients to present an X.509 certificate to identify themselves, irrespective of the secure invocation policy specified in configuration. Hence, the actual level of security that applies to SSL/TLS communications is obtained by implicitly adding `EstablishTrustInClient` to the list of required association options in the target secure invocation policy (the security service does this automatically).

---

### Relocating files

The security service depends on several directories and files, which might need to be relocated when it comes to deployment time. Some directories and files that might be relocated are, as follows:

- *Artix install directory*—if you manually move the core files in the Artix installation, this would affect the location of certain library directories that the security service depends on. The following configuration settings would be affected:
  - ◆ `SECURITY_CLASSPATH`—a substitution variable that specifies the location of the JAR file containing the security service code.
  - ◆ `plugins:java_server:system_properties`—amongst this list of properties, the `java.endorsed.dirs` property would be affected.
- *iS2 properties file*—this is an important file that provides additional security service configuration through Java properties. You can alter the location of this file by editing the `is2.properties` property in the list of properties specified by `plugins:java_server:system_properties`.

- *Security log file*—if you have enabled local logging for the security service, you can specify the location of the security log file by editing the `plugins:local_log_stream:filename` configuration variable.

## Sample configuration

[Example 42](#) shows a sample configuration for a security service that supports connections over the IIOP/TLS transport protocol. In this example, the security service's configuration scope (which would be passed to the `-BUSname` parameter of the command that launches the security service) is `secure_artix.your_application.security_service`.

### Example 42: Configuration of the Artix Security Service with IIOP/TLS

```
# Artix Configuration File
secure_artix
{
1   # Generic security settings
2
   policies:trusted_ca_list_policy =
   "C:\artix_40\artix\4.0\demos/security/certificates/tls/x509/trusted_ca_lists/ca_list1.pem";
3
   SECURITY_CLASSPATH =
   "C:\artix_40\lib\artix\security_service\4.0\security_service-rt.jar";
   ...
   your_application
   {
4       initial_references:IT_SecurityService:reference =
       "corbaloc:it_iiops:1.2@localhost:55020/IT_SecurityService";

       security_service
       {
5           password_retrieval_mechanism:inherit_from_parent =
           "true";
6
           principal_sponsor:use_principal_sponsor = "true";
           principal_sponsor:auth_method_id = "pkcs12_file";
           principal_sponsor:auth_method_data =
           ["filename=C:\artix_40\artix\4.0\demos/security/certificates/tls/x509/certs/services/administrator.p12",
           "password_file=C:\artix_40\artix\4.0\demos/security/certificates/tls/x509/certs/services/administrator.pwf"];

```

**Example 42:** Configuration of the Artix Security Service with IIOP/TLS

```

binding:client_binding_list = ["GIOP+EGMIOP",
"OTS+TLS_Coloc+POA_Coloc", "TLS_Coloc+POA_Coloc",
"OTS+POA_Coloc", "POA_Coloc", "GIOP+SHMIOP",
"CSI+OTS+GIOP+IIOP_TLS", "OTS+GIOP+IIOP_TLS",
"CSI+GIOP+IIOP_TLS", "GIOP+IIOP_TLS", "CSI+OTS+GIOP+IIOP",
"OTS+GIOP+IIOP", "CSI+GIOP+IIOP", "GIOP+IIOP"];

7     policies:target_secure_invocation_policy:requires =
["Confidentiality", "Integrity", "DetectReplay",
"DetectMisordering"];
    policies:target_secure_invocation_policy:supports =
["Confidentiality", "EstablishTrustInTarget",
"EstablishTrustInClient", "DetectMisordering",
"DetectReplay", "Integrity"];
    policies:client_secure_invocation_policy:requires =
["Confidentiality", "Integrity", "DetectReplay",
"DetectMisordering"];
    policies:client_secure_invocation_policy:supports =
["Confidentiality", "EstablishTrustInTarget",
"EstablishTrustInClient", "DetectMisordering",
"DetectReplay", "Integrity"];

8     orb_plugins = ["local_log_stream", "iiop_profile",
"giop", "iiop_tls"];

9     generic_server_plugin = "java_server";
plugins:java_server:shlib_name = "it_java_server";
10    plugins:java_server:class =
"com.ionacorba.security.services.SecurityServer";
    plugins:java_server:classpath = "%{SECURITY_CLASSPATH}";
    plugins:java_server:jni_verbos = "false";
    plugins:java_server:X_options = ["rs"];

11    #event_log:filters = ["IT_SECURITY=WARN+ERROR+FATAL",
"IT_JAVA_SERVER="];
    plugins:security:direct_persistence = "true";

12    plugins:java_server:system_properties =
["org.omg.CORBA.ORBClass=com.ionacorba.art.artimpl.ORBImpl",
"org.omg.CORBA.ORBSingletonClass=com.ionacorba.art.artimpl.ORBSingleton",
"is2.properties=C:\artix_40\artix\4.0\demos\security\full_security\cxx\security_service\is2.properties.FILE",
"java.endorsed.dirs=C:\artix_40\artix\4.0\lib\endorsed"];

```

**Example 42:** Configuration of the Artix Security Service with IIOP/TLS

```

13     plugins:local_log_stream:filename =
        "C:\artix_40\artix\4.0\demos\security\full_security\cxx\security_service\isf.log";
14
        plugins:security:iiop_tls:port = "55020";
        plugins:security:iiop_tls:host = "localhost";
15
        policies:security_server:client_certificate_constraints
        = ["CN=*"];
16
        policies:external_token_issuer:client_certificate_constraints
        = [];
        };
    };
};

```

The preceding configuration can be explained as follows:

1. Most of the settings appearing in the `secure_artix` scope are entirely generic and never need to be edited.
2. By default, the trusted CA list points at a demonstration CA certificate. Before deploying the Artix security service, you must replace this demonstration CA list by a list of CA certificates that are genuinely trustworthy.

**WARNING:** The default trusted CA list is provided for demonstration purposes only. It is *not* secure, because every installation of Artix uses the same demonstration certificates. You must replace the CA certificate list when you deploy the Artix security service to a live system.

3. The `SECURITY_CLASSPATH` substitution variable specifies the location of the JAR file containing the implementation of the Artix security service. If you move the Artix JAR files to a non-standard location, you would have to update this file location.
4. The `IT_SecurityService` initial reference setting provides the endpoint details for connecting to the security service through the IIOP/TLS protocol. You should ensure that this setting is available in the scope of any Artix application that needs to connect to the security service.

The initial reference is specified as a corbaloc URL, in the following format:

```
corbaloc:it_iiopts:1.2@SecurityHost:SecurityPort/IT_Security
Service
```

Where *SecurityHost* and *SecurityPort* are the host and port for the security service.

5. Setting the password retrieval mechanism to obtain the private key password from a parent process is a technicality, which is required because the security service implementation forks a new process.
6. The principal sponsor settings are used to set the security service's own X.509 certificate. The security service uses this certificate during SSL/TLS handshakes to identify itself to other programs.

Before deploying the security service to a live system, you *must* replace the demonstration certificate with a secure custom certificate. For details of how to configure the principal sponsor, see [“Deploying Own Certificate for IIOP/TLS” on page 223](#).

**WARNING:** The security service's default own certificate is provided for demonstration purposes only. It is *not* secure, because every installation of Artix uses the same demonstration certificates. You must replace the own certificate when you deploy the Artix security service to a live system.

7. The following lines set the minimum requirements for the target secure invocation policy and the client secure invocation policy. The security service implicitly augments these security policies by requiring the `EstablishTrustInClient` association option for the target secure invocation policy. In other words, the security service *always* expects a client to present an X.509 certificate, irrespective of what appears in the configuration.
8. The `orb_plugins` list loads plug-ins to support the local log stream and the IIOP/TLS transport protocol.
9. The following lines configure the Artix generic server.  
The core of the Artix security service is implemented as a pure Java program. To make the security service accessible through the IIOP/TLS protocol, the Java code is hosted inside an Artix generic server.

10. The `plugins:java_server:class` setting specifies the entry point for the Java implementation of the security service. Currently, there are two possible entry points:
  - ◆ `com.ionacorba.security.services.SecurityServer`—this entry point is suitable for a security service that supports the IIOP/TLS transport protocol.
  - ◆ `com.ionajbus.security.services.SecurityServer`—this entry point is suitable for a security service that supports other Artix protocols, such as HTTPS. See [“Security Service Accessible through HTTPS” on page 282](#) for more details.
11. To enable an error log for the security service, uncomment this line.
12. This line sets the system properties for the Java implementation of the security service. In particular, the `is2.properties` property specifies the location of a properties file, which contains further property settings for the Artix security service.

Sample property files for the LDAP and KERBEROS security adapters are available at the following locations:

```
ArtixInstallDir/cxx_java/etc/is2.properties.LDAP
ArtixInstallDir/cxx_java/etc/is2.properties.KERBEROS
```

You need to customize these property files before using them in an application—see [“Configuring the LDAP Adapter” on page 295](#) and [“Configuring the Kerberos Adapter” on page 301](#).

13. The `plugins:local_log_stream:filename` specifies the location of the security service’s log file.
14. These two variables, `plugins:security:iiop_tls:port` and `plugins:security:iiop_tls:host`, specify the host and IP port where the security service listens for incoming connections. Therefore, if you want to change the security service’s listening address, you should edit these settings.
15. The security service requires that any clients attempting to open a connection must present an X.509 certificate to identify themselves. In addition, the security service supports a primitive form of access



control: client certificates will be rejected unless they conform to the constraints specified in

```
policies:security_server:client_certificate_constraints.
```

For details of how to specify certificate constraints, see [“Applying Constraints to Certificates”](#) on page 605.

**Note:** The

```
policies:security_server:client_certificate_constraints
```

setting must be present in the security service’s configuration scope, otherwise the security service will not start.

16. The security service supports a special kind of access, where a client can obtain security tokens without providing a password, based on a username alone. This type of access is needed to support interoperability with the mainframe platform. Normally, however, this feature should be disabled to avoid opening a security hole. To disable the token issuer, set the token issuer’s certificate constraints to be an empty list (as shown here). This causes the token issuer to reject all clients, effectively disabling this feature.

**Note:** The

```
policies:external_token_issuer:client_certificate_constraints
```

setting must be present in the security service’s configuration scope, otherwise the security service will not start.

---

## Security Service Accessible through HTTPS

---

### Overview

This section describes how to configure a security service that is made accessible through the HTTPS protocol. A key difference between the HTTPS-based security service and the IIOP/TLS-based security service is that the HTTPS-based variant uses an *Artix enabled* security service. The HTTPS-based variant also requires you to configure clients differently (that is, clients of the security service).

---

### Location of the demonstrations

Demonstrations that show how to configure and run a HTTPS-based security service are provided for both the Java runtime and the C++ runtime.

#### Java runtime

The demonstration code is located in the following directory:

```
ArtixInstallDir/java/samples/security/full_security
```

#### C++ runtime

The demonstration code is located in the following directory:

```
ArtixInstallDir/cxx_java/samples/security/authorization
```

---

### Artix-enabled security service

In versions of Artix prior to 4.0, the Artix security service is available *only* as a pure CORBA service. The architecture for this security service is based on a pure Java core (the core implementation of the security service) which is loaded into an Artix generic server. The generic server provides an OMG IDL wrapper interface, which enables the core service to be accessed through the IIOP/TLS protocol.

From Artix 4.0 onwards, a more flexible type of architecture is provided that makes the security service accessible through *any* Artix transport—that is, the security service is *Artix enabled*. Using this approach, the security service is deployed as a regular Artix service with its own WSDL contract. Just as with any other Artix service, you can select the transport and modify the endpoint attributes by editing the security service's WSDL contract.

---

### Configuring security service clients—Java runtime

For details of how to configure a client of the HTTPS-based security service in the Java runtime, see [“Server-to-Security Server Connection” on page 33](#).

## Configuring security service clients—C++ runtime

If you configure the security service to be Artix enabled, you must also configure the clients of the security service appropriately (in this context, *client* means any program that communicates with the security service—for example, the client could be an Artix server).

To configure an Artix program to communicate with the Artix enabled security service, make the following modifications to the program's configuration:

- *Load the Artix security plug-in*—this is a basic prerequisite for communication with the Artix security service. See [“The Artix Security Plug-In” on page 380](#).
- *Enable Artix proxies in the security plug-in*—set the `policies:asp:use_artix_proxies` configuration variable to `true`.
- *Specify the location of the security service WSDL contract*—set the `bus:initial_contract:url:isf_service` configuration variable to the location of the contract.

**Note:** This is not the only way of specifying the location of a WSDL contract. See the Finding Contracts and References chapter of the *Configuring and Deploying Artix Solutions* guide for more details.

For example, the following configuration sample, `your_artix_server`, highlights the settings that need to be modified in order to access an Artix enabled security service:

```
# Artix Configuration File
your_artix_server
{
    orb_plugins = [..., "artix_security", ...];
    ...
    policies:asp:use_artix_proxies = "true";
    bus:initial_contract:url:isf_service =
    "../etc/isf_service.wsdl";
    ...
};
```

A sample copy of the security service WSDL contract, `isf_service.wsdl`, is provided in the following directory:

`ArtixInstallDir/cxx_java/samples/security/full_security/etc`

### Instantiation of an Artix Bus in the security service

In order to expose the security service as an Artix service, you need to configure the generic server to create an Artix Bus in which the Artix enabled security service can run.

To configure the generic server to instantiate an Artix Bus, perform the following steps:

1. In the `security_service` configuration scope, edit the `plugins:java_server:class` setting and set it equal to `com.iona.jbus.security.services.SecurityServer`.
2. Add a `bus` sub-scope to the `security_service` configuration scope. The `bus` sub-scope is used to configure the Artix enabled security service.

In outline, the modified configuration would look as follows:

```
# Artix Configuration File
security_service
{
    # Security Service Configuration Settings
    ...
    plugins:java_server:class =
    "com.iona.jbus.security.services.SecurityServer";
    ...
    bus
    {
        # HTTPS-Based Security Service Configuration Settings
        ...
    };
};
```

### Customising the security service configuration

To configure the HTTPS-based security service, see the following topics:

- [Setting the HTTPS-based security service's host and port.](#)
- [Location of the security service WSDL contract.](#)
- [Replacing X.509 certificates.](#)
- [Setting client certificate constraints.](#)
- [Minimum level of security.](#)
- [Dependency on secure WSDL publishing service.](#)
- [Relocating files.](#)
- [Sample configuration.](#)

### Setting the HTTPS-based security service's host and port

The HTTPS-based security service's address details are specified in the security service's WSDL contract. If you want to change the security service's address, edit the relevant `location` attribute in the security service endpoint.

[Example 43](#) shows a security service endpoint with a `location` attribute equal to `https://localhost:59075/services/security/ServiceManager`.

#### Example 43: Address Details in the Security Service WSDL Contract

```
<definitions name="isf_service"
  targetNamespace="http://schemas.iona.com/idl/isf_service.idl"
  xmlns="http://schemas.xmlsoap.org/wsdl/"
  xmlns:addressing="http://schemas.iona.com/references"
  xmlns:http="http://schemas.xmlsoap.org/wsdl/http/"

  xmlns:http-conf="http://schemas.iona.com/transport/http/conf
  igation"
  xmlns:soap="http://schemas.xmlsoap.org/wsdl/soap/"
  xmlns:tns="http://schemas.iona.com/idl/isf_service.idl"
  xmlns:xsd="http://www.w3.org/2001/XMLSchema"

  xmlns:xsd1="http://schemas.iona.com/idl/types/isf_service.idl"
  >
  ...
  <service name="IT_ISF.ServiceManagerSOAPService">
    <port binding="tns:IT_ISF.ServiceManagerSOAPBinding"
      name="IT_ISF.ServiceManagerSOAPPort">
      <http:address location =
"https://localhost:59075/services/security/ServiceManager"
      />
    </port>
  </service>
</definitions>
```

### Location of the security service WSDL contract

The location of the security service WSDL contract is specified by the value of the `bus:initial_contract:url:isf_service` variable in the `bus` sub-scope of the security service's configuration scope.

A sample copy of the security service WSDL contract, `isf_service.wsdl`, is provided in the following directories:

```
ArtixInstallDir/java/samples/security/authorization/etc
ArtixInstallDir/cxx_java/samples/security/full_security/etc
```

---

## Replacing X.509 certificates

The security service is provided with demonstration X.509 certificates by default. Whilst this is convenient for running demonstrations and tests, it is fundamentally insecure, because Artix provides identical demonstration certificates for every installation.

Before deploying the security service in a live system, therefore, you *must* replace the default X.509 certificates with your own custom-generated certificates. Specifically, for the security service you must replace the following certificates:

- *Trusted CA list*—this is a list of trusted Certification Authority (CA) certificates, which is used to vet certificates presented by clients. Only certificates signed by one of the CAs on the trusted list will be allowed to connect to the security service.

To update the trusted CA list, edit the

`plugins:at_http:server:trusted_root_certificates` variable in the `bus` sub-scope of the the security service's configuration scope. For more details, see [“Specifying Trusted CA Certificates for HTTPS—C++ Runtime” on page 209](#).

- *Security service's own certificate*—the security service uses its own X.509 certificate to identify itself to peers during SSL/TLS handshakes.

To replace the security service's own certificate, edit the

`plugins:at_http:server:server_certificate` and the `plugins:at_http:server:server_private_key_password` settings in the `bus` sub-scope of the security service's configuration scope. For more details, see [“Deploying Own Certificate for HTTPS—C++ Runtime” on page 219](#).

---

## Setting client certificate constraints

To provide a basic level of access control, the security service enables you to set client certificate constraints, which prevents clients from opening a connection to the security service unless they present an certificate that matches the specified constraints.

To specify the HTTPS-based security service's client certificate constraints, assign the constraints to the `policies:certificate_constraints_policy` configuration variable in the `bus` configuration sub-scope (for details of how to specify constraints, see [“Applying Constraints to Certificates” on page 605](#)).

**Note:** The HTTPS-based security service sets certificate constraints using a different variable, `policies:certificate_constraints_policy`, from the one used by the IIOP/TLS-based security service, `policies:security_server:client_certificate_constraints`.

---

### Minimum level of security

In the case of the HTTPS-based security service, the minimum security requirements for SSL/TLS communications are specified explicitly by the effective target secure invocation policy (which can be specified using the `policies:target_secure_invocation_policy:requires` variable).

Because it is an important security requirement for clients of the security service to present an X.509 certificate, you should take care that the target secure invocation policy in the `bus` configuration sub-scope always includes the `EstablishTrustInClient` association option.

---

### Dependency on secure WSDL publishing service

The HTTPS-based security service requires that the secure WSDL publishing service is loaded and enabled. The WSDL publishing service enables clients of the security service to download WSDL contracts containing particular security service interfaces at runtime.

For more details about the secure WSDL publishing service, see [“Publishing WSDL Securely—C++ Runtime” on page 419](#).

---

### Relocating files

The security service depends on several directories and files, which might need to be relocated when it comes to deployment time. Some directories and files that might be relocated are, as follows:

- *Artix install directory*—if you manually move the core files in the Artix installation, this would affect the location of certain library directories that the security service depends on. The following configuration settings would be affected:
  - ◆ `SECURITY_CLASSPATH`—a substitution variable that specifies the location of the JAR file containing the security service code.

- ◆ `plugins:java_server:system_properties`—amongst this list of properties, the `java.endorsed.dirs` property would be affected.
- *iS2 properties file*—this is an important file that provides additional security service configuration through Java properties. You can alter the location of this file by editing the `is2.properties` property in the list of properties specified by `plugins:java_server:system_properties`.
- *Security log file*—if you have enabled local logging for the security service, you can specify the location of the security log file by editing the `plugins:local_log_stream:filename` configuration variable.
- *iSF service file*—you can change the location of the WSDL contract file for the HTTPS-based security service by editing the `bus:initial_contract:url:isf_service` configuration variable.

## Sample configuration

[Example 44](#) shows a sample configuration for a security service that supports connections over the HTTPS transport protocol. In this example, the security service's configuration scope (which would be passed to the `-BUSname` parameter of the command that launches the security service) is `secure_artix.your_application.security_service`.

### Example 44: Configuration of the Artix Security Service with HTTPS

```

1 include "../../../../../etc/domains/artix.cfg";

secure_artix
{
    # Generic security settings
    ...
    your_application
    {
        ...
        security_service
        {
            ...
2         generic_server_plugin = "java_server";
           plugins:java_server:shlib_name = "it_java_server";
3         plugins:java_server:class =
"com.iona.jbus.security.services.SecurityServer";
           plugins:java_server:classpath = "%{SECURITY_CLASSPATH}";
           plugins:java_server:jni_verbose = "false";

```



**Example 44:** Configuration of the Artix Security Service with HTTPS

```

4     plugins:java_server:X_options = ["rs"];
      #event_log:filters = ["IT_SECURITY=WARN+ERROR+FATAL",
"IT_JAVA_SERVER="];
      plugins:security:direct_persistence = "true";

5     plugins:java_server:system_properties =
["org.omg.CORBA.ORBClass=com.iona.corba.art.artimpl.ORBImpl",
"org.omg.CORBA.ORBSingletonClass=com.iona.corba.art.artimpl.O
RBSingleton",
"is2.properties=%{INSTALL_DIR}/%{PRODUCT_NAME}/%{PRODUCT_VERS
ION}/demos/security/full_security/etc/is2.properties.FILE",
"java.endorsed.dirs=%{INSTALL_DIR}/%{PRODUCT_NAME}/%{PRODUCT_
VERSION}/lib/endorsed"];

6     plugins:local_log_stream:filename =
"%{INSTALL_DIR}/%{PRODUCT_NAME}/%{PRODUCT_VERSION}/demos/secu
rity/full_security/etc/isf.log";
      ...
      bus
      {
7         orb_plugins = ["local_log_stream", "java",
"wsdl_publish"];
8         java_plugins= ["isf"];
plugins:isf:classname="com.iona.jbus.security.services.ISFBusPlu
ginFactory";

9         bus:initial_contract:url:isf_service =
"%{INSTALL_DIR}/%{PRODUCT_NAME}/%{PRODUCT_VERSION}/demos/secu
rity/full_security/etc/isf_service.wsdl";

10        plugins:wsdl_publish:enable_secure_wsdl_publish="true";

11        plugins:at_http:server:use_secure_sockets="true";
12        plugins:at_http:server:trusted_root_certificates =
"%{ROOT_TRUSTED_CA_LIST_POLICY_1}";
13        plugins:at_http:server:server_certificate =
"%{PRIVATE_CERT_1}";
      plugins:at_http:server:server_private_key_password =
"%{PRIVATE_CERT_PASSWORD_1}";
14        policies:target_secure_invocation_policy:requires =
["Confidentiality", "Integrity", "DetectMisordering",
"DetectReplay", "EstablishTrustInClient"];
15        policies:certificate_constraints_policy =
["%{CERT_CONSTRAINT_1}"];
      };

```

**Example 44:** Configuration of the Artix Security Service with HTTPS

```

    };
};
};

```

The preceding configuration can be described as follows:

1. The included `artix.cfg` configuration file contains some generic configuration and settings to initialize the security substitution variables.

**Note:** Substitution variables provide a simple way of defining constants in an Artix configuration file. If you define a substitution variable, `VARIABLE_NAME`, you can substitute its value into a configuration setting using the syntax `%{VARIABLE_NAME}`.

2. The following lines configure the Artix generic server.  
The core of the Artix security service is implemented as a pure Java program, which gets loaded into the Artix generic server.
3. The `plugins:java_server:class` setting specifies the entry point for the Java implementation of the security service. Currently, there are two possible entry points:
  - ◆ `com.iona.jbus.security.services.SecurityServer`—this entry point is suitable for running a HTTPS-based security service. The detailed configuration of the HTTPS transport appears inside the `bus` configuration sub-scope.
  - ◆ `com.iona.corba.security.services.SecurityServer`—this entry point is suitable for running an IIOP/TLS-based security service. See [“Security Service Accessible through IIOP/TLS” on page 273](#) for details.
4. To enable an error log for the security service, uncomment this line.
5. This line sets the system properties for the Java implementation of the security service. In particular, the `is2.properties` property specifies the location of a properties file, which contains further property settings for the Artix security service.
6. The `plugins:local_log_stream:filename` specifies the location of the security service's log file.

7. The `orb_plugins` list in the bus scope must include the following plug-ins:
  - ♦ `java_plugin`—enables the Artix Java plug-in mechanism, which can then be loaded using the `java_plugins` list.
  - ♦ `wSDL_publish_plugin`—loads the WSDL publishing service, which enables clients of the security service to download WSDL contracts. In order to access some of the security service's interfaces, the client must download the relevant WSDL contracts through the publishing service.
8. The `java_plugins` list lets you load Artix Java plug-ins (see the *JAX-RPC Programmer's Guide* for more details) and in this case a single plug-in, `isf`, is loaded. The `isf` plug-in is responsible for exposing the security service core as an Artix service.  
The `plugins:isf:classname` variable specifies the entry point for the implementation of the `isf` plug-in.
9. This setting specifies the location of the security service's WSDL contract. You will generally need to edit this WSDL contract, to specify the security service's host and port.
10. This setting enables HTTPS-related security features for the WSDL publishing service. For more details about securing the WSDL publishing service, see [“Enabling SSL/TLS for WSDL Publish Plug-In” on page 428](#).
11. This setting ensures that the security service and the WSDL publishing service accept incoming connections only over HTTPS, instead of insecure HTTP, and implicitly causes the `https` plug-in to load.
12. If the client presents a certificate to the security service, Artix checks to make sure that the client certificate is signed by one of the CAs in the trusted CA list specified here.
13. This line specifies the X.509 certificate that the security server presents to incoming HTTPS connections during an SSL/TLS handshake.
14. The specified target secure invocation policy includes the `EstablishTrustInClient` association option, which ensures that the security service accepts connections *only* from clients that present an X.509 certificate.

15. The HTTPS-based security service supports a primitive form of access control, whereby client certificates are rejected unless they conform to the constraints specified in

`policies:certificate_constraints_policy`.

For details of how to specify certificate constraints, see [“Applying Constraints to Certificates”](#) on page 605.

**Note:** The `policies:certificate_constraints_policy` setting is fundamentally important for securing the security service. This is the only mechanism (apart from checking the certificate’s signature) that the security service can use to restrict access to itself.

---

# Configuring the File Adapter

---

## Overview

The iSF file adapter enables you to store information about users, roles, and realms in a flat file, a *security information file*. The file adapter is easy to set up and configure, but is appropriate mainly for demonstration purposes and small deployments. This section describes how to set up and configure the iSF file adapter.

**Note:** The file adapter is a simple adapter that does *not* scale well for large enterprise applications. IONA supports the use of the file adapter in a production environment, but the number of users is limited to 200.

---

## File locations

The following files configure the iSF file adapter:

- `is2.properties` file—sample `isf.properties` files for the FILE, LDAP, and Kerberos adapters are available at the following locations:

```
ArtixInstallDir/cxx_java/samples/security/full_security/etc
/is2.properties.FILE
ArtixInstallDir/cxx_java/etc/is2.properties.LDAP
ArtixInstallDir/cxx_java/etc/is2.properties.KERBEROS
```

See “[iSF Properties File](#)” on [page 699](#) for details of how to customize the default iS2 properties file location.

- Security information file—this file’s location is specified by the `com.iona.isp.adapter.file.param.filename` property in the `is2.properties` file.

**File adapter properties**

[Example 45](#) shows the properties to set for a file adapter.

**Example 45: Sample File Adapter Properties**

```

1  com.iona.isp.adapters=file

#####
##
## Demo File Adapter Properties
##
#####
2  com.iona.isp.adapter.file.class=com.iona.security.is2adapter.fil
   e.FileAuthAdapter
3  com.iona.isp.adapter.file.param.filename=ArtixInstallDir/cxx_jav
   a/samples/security/full_security/etc/is2_user_password_file.t
   xt

#####
## General Artix security service Properties
#####
4  # ... Generic properties not shown here ...

```

The necessary properties for a file adapter are described as follows:

1. Set `com.iona.isp.adapters=file` to instruct the Artix security service to load the file adapter.
2. The `com.iona.isp.adapter.file.class` property specifies the class that implements the iSF file adapter.
3. The `com.iona.isp.adapter.file.param.filename` property specifies the location of the security information file, which contains information about users and roles.
4. (*Optionally*) You might also want to edit the general Artix security service properties.

See [“Additional Security Configuration” on page 330](#) for details.

---

# Configuring the LDAP Adapter

---

## Overview

The IONA security platform integrates with the Lightweight Directory Access Protocol (LDAP) enterprise security infrastructure by using an LDAP adapter. The LDAP adapter is configured in an `is2.properties` file. This section discusses the following topics:

- [Prerequisites](#)
- [File location](#).
- [Minimal LDAP configuration](#).
- [Basic LDAP properties](#).
- [LDAP.param properties](#).
- [LDAP server replicas](#).
- [Logging on to an LDAP server](#).

---

## Prerequisites

Before configuring the LDAP adapter, you must have an LDAP security system installed and running on your system. LDAP is *not* a standard part of Artix, but you can use the Artix security service's LDAP adapter with any LDAP v.3 compatible system.

---

## File location

The following file configures the LDAP adapter:

- `is2.properties` file—the default location of the iS2 properties file is as follows:

```
ArtixInstallDir/cxx_java/etc/is2.properties.LDAP
```

See [“iSF Properties File” on page 699](#) for details of how to customize the default iS2 properties file location.

**Minimal LDAP configuration**

[Example 46](#) shows the minimum set of iS2 properties that can be used to configure an LDAP adapter.

**Example 46:** *A Sample LDAP Adapter Configuration File*

```

1  com.ionas2.adapter.LDAP
   #####
   ##
   ## LDAP Adapter Properties
   ##
   #####
2  com.ionas2.adapter.LDAP.class=com.ionas2.adapter.LdapAdapter

3  com.ionas2.adapter.LDAP.param.host.1=10.81.1.400
   com.ionas2.adapter.LDAP.param.port.1=389

4  com.ionas2.adapter.LDAP.param.UserNameAttr=uid
   com.ionas2.adapter.LDAP.param.UserBasedDN=dc=ionas2,dc=com
   com.ionas2.adapter.LDAP.param.UserObjectClass=organizationalPerson
   com.ionas2.adapter.LDAP.param.UserSearchScope=SUB

5  com.ionas2.adapter.LDAP.param.UserRoleDNAttr=nsroledn
   com.ionas2.adapter.LDAP.param.RoleNameAttr=cn

6  com.ionas2.adapter.LDAP.param.GroupNameAttr=cn
   com.ionas2.adapter.LDAP.param.GroupObjectClass=groupofuniqueNames
   com.ionas2.adapter.LDAP.param.GroupSearchScope=SUB
   com.ionas2.adapter.LDAP.param.GroupBaseDN=dc=ionas2,dc=com
   com.ionas2.adapter.LDAP.param.MemberDNAttr=uniqueMember

7  com.ionas2.adapter.LDAP.param.version=3

```

The necessary properties for an LDAP adapter are described as follows:

1. Set `com.ionas2.adapter.LDAP` to instruct the IONA Security Platform to load the LDAP adapter.
2. The `com.ionas2.adapter.file.class` property specifies the class that implements the LDAP adapter.



3. For each LDAP server replica, you must specify the host and port where the LDAP server can be contacted. In this example, the host and port parameters for the primary LDAP server, `host.1` and `port.1`, are specified.
4. These properties specify how the LDAP adapter finds a user name within the LDAP directory schema. The properties are interpreted as follows:

<code>UserNameAttr</code>	The attribute type whose corresponding value uniquely identifies the user.
<code>UserBaseDN</code>	The base DN of the tree in the LDAP directory that stores user object class instances.
<code>UserObjectClass</code>	The attribute type for the object class that stores users.
<code>UserSearchScope</code>	The user search scope specifies the search depth relative to the user base DN in the LDAP directory tree. Possible values are: <code>BASE</code> , <code>ONE</code> , or <code>SUB</code> .

See [“iSF Properties File” on page 699](#) for more details.

5. The following properties specify how the adapter extracts a user’s role from the LDAP directory schema:

<code>UserRoleDNAttr</code>	The attribute type that stores a user’s role DN.
<code>RoleNameAttr</code>	The attribute type that the LDAP server uses to store the role name.

6. These properties specify how the LDAP adapter finds a group name within the LDAP directory schema. The properties are interpreted as follows:

<code>GroupNameAttr</code>	The attribute type whose corresponding attribute value gives the name of the user group.
<code>GroupBaseDN</code>	The base DN of the tree in the LDAP directory that stores user groups.
<code>GroupObjectClass</code>	The object class that applies to user group entries in the LDAP directory structure.

GroupSearchScope	The group search scope specifies the search depth relative to the group base DN in the LDAP directory tree. Possible values are: BASE, ONE, OR SUB.
MemberDNAttr	The attribute type that is used to retrieve LDAP group members.

See [“iSF Properties File” on page 699](#) for more details.

7. The LDAP version number can be either 2 or 3, corresponding to LDAP v.2 or LDAP v.3 respectively.

### Basic LDAP properties

The following properties must always be set as part of the LDAP adapter configuration:

```
com.iona.isp.adapters=LDAP
com.iona.isp.adapter.LDAP.class=com.iona.security.is2adapter.ldap.LdapAdapter
```

In addition to these basic properties, you must also set a number of LDAP parameters, which are prefixed by `com.iona.isp.adapter.LDAP.param`.

**LDAP.param properties**

Table 9 shows all of the LDAP adapter properties from the `com.ionas.adapter.LDAP.param` scope. Required properties are shown in bold:

**Table 9:** *LDAP Properties in the com.ionas.adapter.LDAP.param Scope*

LDAP Server Properties	LDAP User/Role Configuration Properties
<b>host</b> .<Index> <b>port</b> .<Index> SSLEnabled.<Index> SSLCACertDir.<Index> SSLClientCertFile.<Index> SSLClientCertPassword.<Index> PrincipalUserDN.<Index> PrincipalUserPassword.<Index>	<b>UserNameAttr</b> <b>UserBaseDN</b> <b>UserObjectClass</b> <b>UserSearchScope</b> UserSearchFilter <b>UserRoleDNAttr</b> <b>RoleNameAttr</b> UserCertAttrName
LDAP Group/Member Configuration Properties	Other LDAP Properties
<b>GroupNameAttr</b> <b>GroupObjectClass</b> <b>GroupSearchScope</b> <b>GroupBaseDN</b> <b>MemberDNAttr</b> MemberFilter	MaxConnectionPoolSize <b>version</b> UseGroupAsRole RetrieveAuthInfo CacheSize CacheTimeToLive

**LDAP server replicas**

The LDAP adapter is capable of failing over to one or more backup replicas of the LDAP server. Hence, properties such as `host.<Index>` and `port.<Index>` include a replica index as part of the parameter name.

For example, `host.1` and `port.1` refer to the host and port of the primary LDAP server, while `host.2` and `port.2` would refer to the host and port of an LDAP backup server.

---

**Logging on to an LDAP server**

The following properties can be used to configure login parameters for the *<Index>* LDAP server replica:

PrincipalUserDN. *<Index>*  
PrincipalUserPassword. *<Index>*

The properties need only be set if the LDAP server is configured to require username/password authentication.

---

**Secure connection to an LDAP server**

The following properties can be used to configure SSL/TLS security for the connection between the Artix security service and the *<Index>* LDAP server replica:

SSLEnabled. *<Index>*  
SSLCA CertDir. *<Index>*  
SSLClientCertFile. *<Index>*  
SSLClientCertPassword. *<Index>*

The properties need only be set if the LDAP server requires SSL/TLS mutual authentication.

---

**iS2 properties reference**

For more details about the Artix security service properties, see [“iSF Properties File” on page 699](#).

---

# Configuring the Kerberos Adapter

---

**Overview**

The Kerberos adapter enables you to use the Kerberos Authentication Service. By configuring the Kerberos adapter, you ensure that any authentication requests within the Artix Security Framework are delegated to Kerberos. This section describes how to set up and configure the Kerberos adapter.

---

**In this section**

This section contains the following subsections:

<a href="#">Overview of Kerberos Configuration</a>	<a href="#">page 302</a>
<a href="#">Configuring the KDC Connection</a>	<a href="#">page 305</a>
<a href="#">Configuring the Active Directory Connection</a>	<a href="#">page 308</a>
<a href="#">Sample Kerberos Configuration</a>	<a href="#">page 311</a>

---

## Overview of Kerberos Configuration

---

### Kerberos adapter

The Kerberos adapter integrates Kerberos into the Artix security framework by treating the Artix security service as a Kerberos server. The Artix system of role-based access control can also optionally be integrated with an LDAP directory service (for example, Active Directory) that stores the user and role information.

---

### Kerberos Distribution Center (KDC)

The Kerberos Distribution Centre (KDC) server is responsible for managing authentication in a Kerberos system. When a client authenticates with the KDC server, the client receives a ticket that allows it to talk to the Artix security service. The client then sends the ticket to an Artix server (through a WS-Security SOAP header) and the server authenticates the ticket by sending it to the Artix security service, which forwards the ticket to the KDC server.

---

### JAAS login module

The Kerberos adapter is required to log into the KDC server before it can start verifying tickets on behalf of servers.

To perform the login step, the Kerberos adapter uses the Java Authentication and Authorization Service (JAAS). The JAAS API is a general purpose wrapper that enables Java programs to perform authentication and authorization in a technology-neutral way. Specific security technologies are supported by loading the relevant plug-in modules—see <http://java.sun.com/products/jaas/> for details.

To perform a Kerberos login, JAAS loads the Kerberos login module and obtains login credentials by reading the `jaas.conf` configuration file. See “JAAS login properties” on page 306 for more details.

---

### LDAP directory

The LDAP directory stores user and role information. The Kerberos adapter can optionally access the directory to obtain role information, which can then be used to perform authorization in the context of the Artix security framework.

LDAP directory is a database whose entries are organized in a hierarchical scheme based on the X.500 standard. For details of the system for naming entries in an LDAP directory, see “ASN.1 and Distinguished Names” on page 731.

---

### Active Directory service

Active Directory is the Microsoft implementation of Kerberos, which is integrated into Windows 2000 and other Windows operating systems. Because Active Directory includes a KDC server and an LDAP directory, you can integrate the Kerberos adapter with Active Directory.

For more details about Active Directory, see the [Microsoft Active Directory Web pages](#).

---

### Kerberos realm

A *Kerberos realm* is an administrative domain with its own Kerberos database that stores data on users and services belonging to that domain. Conventionally, a Kerberos realm is spelt all uppercase—for example, IONA.COM.

---

### Kerberos principal

A *Kerberos principal* identifies a user or service within a particular Kerberos domain. The following naming conventions are used for Kerberos principals:

- *Client principal*—follows the convention *UserName@KerberosRealm*. For example:

```
Fred.Flintstone@IONA.COM
```

- *Server principal*—follows the convention *ServiceName/HostName@KerberosRealm*. For example, the service, `WebServer`, running on host, `web01.iona.com`, in realm, `IONA.COM`, would have the following principal:

```
WebServer/web01.iona.com@IONA.COM
```

Formally, `WebServer` is the *primary* and `web01.iona.com` is the *instance* part of the principal. This two-part name acknowledges the fact that a single service could be replicated on different hosts. The Kerberos naming convention enables each replica to have a unique principal.

**Kerberos keyTab file**

A *Kerberos keyTab* file (short for key table file) stores the password associated with a server. It is important to protect this file by setting file permissions to restrict ordinary users from reading from or writing to the file.

**File location**

The Kerberos adapter is configured by an `is2.properties` file. A sample properties file for configuring Kerberos is provided at the following location:

```
ArtixInstallDir/cxx_java/etc/is2.properties.KERBEROS
```

To define properties for the Kerberos adapter, make a copy of this file and customize it for your particular deployment. To specify the location of your properties file, edit the Artix configuration file, setting the `is2.properties` property in the `plugins:java_server:system_properties` list to the location of the Kerberos adapter properties file, *KerberosPropertiesFile*, as shown in [Example 47](#).

**Example 47: Specifying the Location of the Kerberos Properties File**

```
# Artix Configuration File
secure_artix
{
  your_application
  {
    security_service
    {
      ...
      plugins:java_server:system_properties =
["org.omg.CORBA.ORBClass=com.ion.corba.art.artimpl.ORBImpl",
"org.omg.CORBA.ORBSingletonClass=com.ion.corba.art.artimpl.ORBSingleton",
"is2.properties=KerberosPropertiesFile",
"java.endorsed.dirs=C:\artix_40/artix/4.2/lib/endorsed"];
      ...
    };
  };
};
```



---

## Configuring the KDC Connection

---

### Overview

This subsection explains how to configure the Kerberos adapter to connect to the Kerberos Distribution Center (KDC) server. The following topics are described in this subsection:

- [Enabling the Kerberos adapter.](#)
- [KDC connection properties.](#)
- [JAAS login properties.](#)
- [Kerberos logging support.](#)
- [Other KDC configuration options.](#)

---

### Enabling the Kerberos adapter

The first thing you need to do is to instruct the Artix Security Service to load the Kerberos adapter. The following two lines in the `is2.properties` file specify the Kerberos adapter:

```
# is2.properties File
com.ionasecurity.is2.adapter.krb5.class=com.ionasecurity.is2.adapter.krb5.IS2KerberosAdapter
```

Where the `com.ionasecurity.is2.adapter.krb5` setting tells the security service to use the Kerberos adapter, `krb5`, and the `com.ionasecurity.is2.adapter.krb5.class` setting specifies the class that implements the Kerberos adapter.

---

### KDC connection properties

The following properties in the `com.ionasecurity.is2.adapter.krb5.param.scope` specify the connection details for the KDC server:

```
java.security.krb5.realm
java.security.krb5.kdc
```

Where `realm` is the Kerberos realm name and `kdc` is the host name or IP address of the KDC host. This is the minimum amount of information required for connecting to a KDC server. If you need to specify further connection details, however, you can use a `krb5.conf` file—see [“com.ionasecurity.is2.adapter.krb5.param.java.security.krb5.conf” on page 704](#) for details.

## JAAS login properties

In addition to specifying the KDC connection properties, you also need to specify the JAAS login properties, which enable the Kerberos adapter to log on to the KDC server. Specify the location of the `jaas.conf` file by setting the following property in the `com.ionasp.adapter.krb5.param` SCOPE:

```
java.security.auth.login.config
```

The `jaas.conf` file has a standard format defined by the JAAS standard. [Example 48](#) shows a sample `jaas.conf` file that demonstrates how to configure the JAAS Kerberos login module.

### Example 48: Sample `jaas.conf` File for the Kerberos Login Module

```
/* Login Configuration for JAAS */  
  
com.sun.security.jgss.initiate {  
    com.sun.security.auth.module.Krb5LoginModule required;  
};  
  
com.sun.security.jgss.accept {  
    com.sun.security.auth.module.Krb5LoginModule required  
    storeKey=true principal="ServerPrincipalName@REALM"  
    useKeyTab = true keyTab="krb5.keytab" ;  
};
```

The `com.sun.security.jgss.accept` scope defines the server-side login behavior. There are two essential properties that you need to specify:

- `principal`—Kerberos identity of the Artix Security Server. See [“Kerberos principal” on page 303](#) for more details.
- `keyTab`—the location of a file that contains the password for the principal. This is the usual method for storing a server-side password in a Kerberos system. See [“Kerberos keyTab file” on page 304](#) for more details.

## Kerberos logging support

You can set two additional properties to check whether a valid Kerberos KDC is running when the Artix security service starts up. [Example 49](#) shows how to configure the relevant properties:

### Example 49: Configuration to Enable Kerberos Logging Support

```
# is2.properties File
com.iona.isp.adapter.krb5.param.check.kdc.running=true
com.iona.isp.adapter.krb5.param.check.kdc.principal=DummyPrincipal
```

The *DummyPrincipal* is a principal that is used for connecting to the KDC server to check whether it is running. If the KDC server is not running, the Artix security service writes a warning to its log.

## Other KDC configuration options

The following property in the `com.iona.isp.adapter.krb5.param` scope must *always* be set to `false`:

```
javax.security.auth.useSubjectCredsOnly
```

Essentially, this is an implementation detail of the Kerberos adapter. If the property is `true`, it signals to the Java security API that the Kerberos credentials must be stored in a `javax.security.auth.Subject` object. If the property is `false`, it signals that the Kerberos credentials can be stored in an implementation-dependent manner (required for the Kerberos adapter).

---

## Configuring the Active Directory Connection

---

### Overview

This subsection explains how to configure the Kerberos adapter to connect to the Active Directory LDAP server. Many of the properties described here are analogous to properties that configure the LDAP adapter (see [“Configuring the LDAP Adapter” on page 295](#)). The following topics are described in this subsection:

- [LDAP server replicas.](#)
- [LDAP host and port.](#)
- [Logging on to an LDAP server.](#)
- [Secure connection to an LDAP server.](#)
- [Connection timeout.](#)
- [Specifying the LDAP version.](#)
- [Enabling retrieval of group information.](#)
- [Configuring the user schema.](#)
- [Configuring the group schema.](#)
- [Setting the connection pool size.](#)

---

### LDAP server replicas

The LDAP adapter is capable of failing over to one or more backup replicas of the LDAP server. Hence, properties such as `host.<Index>` and `port.<Index>` include a replica index as part of the parameter name.

---

### LDAP host and port

To specify the host and IP port of the LDAP adapter, set the following properties in the `com.ionas.isp.adapter.krb5.param` scope:

```
host.<Index>  
port.<Index>
```

Where `<Index>` refers to a particular failover replica. For example, `host.1` and `port.1` refer to the host and port of the primary LDAP server, while `host.2` and `port.2` would refer to the host and port of an LDAP backup server.

---

**Logging on to an LDAP server**

The following properties in the `com.ionasp.adapter.krb5.param` scope can be used to configure login parameters for the *<Index>* LDAP server replica:

```
PrincipalUserDN.<Index>  
PrincipalUserPassword.<Index>
```

The properties need only be set if the LDAP server is configured to require username/password authentication.

---

**Secure connection to an LDAP server**

The following properties in the `com.ionasp.adapter.krb5.param` scope can be used to configure SSL/TLS security for the connection between the Artix security service and the *<Index>* LDAP server replica:

```
SSLEnabled.<Index>  
SSLCA CertDir.<Index>  
SSLClientCertFile.<Index>  
SSLClientCertPassword.<Index>
```

The properties need only be set if the LDAP server requires SSL/TLS mutual authentication.

---

**Connection timeout**

The following property in the `com.ionasp.adapter.krb5.param` scope can be used to configure a connection timeout for the *<Index>* LDAP server replica:

```
ConnectTimeout.<Index>
```

---

**Specifying the LDAP version**

The following property in the `com.ionasp.adapter.krb5.param` scope is used to specify the version of the LDAP server:

```
version
```

The LDAP version can be either 2 or 3.

---

**Enabling retrieval of group information**

To enable retrieval of group information from the LDAP server, set the following property in the `com.ionasp.adapter.krb5.param` scope to `true`:

```
RetrieveAuthInfo
```

---

**Configuring the user schema**

The following properties in the `com.ionasp.adapter.krb5.param` SCOPE are used to configure details of the user schema in the LDAP repository:

```
UserNameAttr
UserBaseDN
UserObjectClass
UserSearchFilter
UserRoleDNAttr
RoleNameAttr
UserCertAttrName
```

---

**Configuring the group schema**

The following properties in the `com.ionasp.adapter.krb5.param` SCOPE are used to configure details of the group schema in the LDAP repository:

```
GroupNameAttr
GroupObjectClass
GroupSearchScope
GroupBaseDN
MemberDNAttr
```

---

**Setting the connection pool size**

The following properties in the `com.ionasp.adapter.krb5.param` SCOPE can be used to set the LDAP connection pool size:

```
MaxConnectionPoolSize
MinConnectionPoolSize
```

## Sample Kerberos Configuration

### Kerberos is2.properties file

[Example 50](#) shows a sample `is2.properties` file that could be used to configure the Kerberos adapter.

#### Example 50: *Sample Kerberos is2.properties File*

```
# is2.properties File
com.iona.isp.adapters=krb5

#####
##
## Kerberos Adapter Properties
##
#####
com.iona.isp.adapter.krb5.class=com.iona.security.is2adapter.krb
  5.IS2KerberosAdapter
com.iona.isp.adapter.krb5.param.java.security.krb5.realm=YOUR_RE
  ALM
com.iona.isp.adapter.krb5.param.java.security.krb5.kdc=YOUR_KDC_
  SERVER
com.iona.isp.adapter.krb5.param.java.security.auth.login.config=
  jaas.conf
com.iona.isp.adapter.krb5.param.javax.security.auth.useSubjectCr
  edsOnly=false
#com.iona.isp.adapter.krb5.param.sun.security.krb5.debug=true

#To retrieve group info from active directory, change this to
  true
com.iona.isp.adapter.krb5.param.RetrieveAuthInfo=false

com.iona.isp.adapter.krb5.param.host.1=YOUR_ACTIVE_DIRECTORY_SER
  VER
com.iona.isp.adapter.krb5.param.port.1=389
#com.iona.isp.adapter.krb5.param.SSLEnabled.1=no
#com.iona.isp.adapter.krb5.param.SSLCACertDir.1=
#com.iona.isp.adapter.krb5.param.SSLClientCertFile.1=
#com.iona.isp.adapter.krb5.param.SSLClientCertPassword.1=
com.iona.isp.adapter.krb5.param.PrincipalUserDN.1=YOUR_PRINCIPAL
  _USER_DN
com.iona.isp.adapter.krb5.param.PrincipalUserPassword.1=YOUR_PRI
  NCIPAL_PASSWORD
com.iona.isp.adapter.krb5.param.ConnectTimeout.1=15
```

**Example 50:** *Sample Kerberos is2.properties File*

```

com.iona.isp.adapter.krb5.param.UserNameAttr=CN
com.iona.isp.adapter.krb5.param.UserBaseDN=dc=boston,dc=amer,dc=
iona,dc=com
com.iona.isp.adapter.krb5.param.version=3
com.iona.isp.adapter.krb5.param.UserObjectClass=Person
com.iona.isp.adapter.krb5.param.GroupObjectClass=group
com.iona.isp.adapter.krb5.param.GroupSearchScope=SUB
com.iona.isp.adapter.krb5.param.GroupBaseDN=dc=boston,dc=amer,dc
=iona,dc=com
com.iona.isp.adapter.krb5.param.GroupNameAttr=CN
com.iona.isp.adapter.krb5.param.MemberDNAttr=memberOf
#com.iona.isp.adapter.krb5.param.UseGroupAsRole=yes
com.iona.isp.adapter.krb5.param.MaxConnectionPoolSize=1
com.iona.isp.adapter.krb5.param.MinConnectionPoolSize=1

#com.iona.isp.adapter.krb5.param.UserRoleDNAttr=nsroledn
#com.iona.isp.adapter.krb5.param.RoleNameAttr=CN
#com.iona.isp.adapter.krb5.param.UserSearchFilter=
#com.iona.isp.adapter.krb5.param.UserCertAttrName=userCertificat
e

#####
##
## Single Sign On Session Info
##
#####
is2.sso.session.timeout=600
is2.sso.session.idle.timeout=60
is2.sso.cache.size=200

#####
##
## Log4j configuration
##
#####
#log4j.configuration=log4j.properties

```



---

# Clustering and Federation

---

## Overview

Clustering and federation are two distinct, but related, features of the Artix security service. Briefly, these features can be described as follows:

- *Federation (C++ runtime and Java runtime)*—enables SSO tokens to be recognized across multiple security domains. Each security domain is served by a distinct security service instance and each security service is integrated with a different database back-end.
- *Clustering (C++ runtime)*—involves running several instances of the Artix security service to provide what is effectively a single service. By running multiple security service instances as a *cluster*, Artix enables you to support fault tolerance features. Typically, in this case all of the security services in a cluster are integrated with a single authentication database back-end.

## In this section

This section contains the following subsections:

<a href="#">Federating the Artix Security Service</a>	<a href="#">page 314</a>
<a href="#">Failover—C++ Runtime</a>	<a href="#">page 319</a>
<a href="#">Client Load Balancing—C++ Runtime</a>	<a href="#">page 327</a>

---

## Federating the Artix Security Service

---

### Overview

Federation is meant to be used in deployment scenarios where there is more than one instance of an Artix security service. By configuring the Artix security service instances as a federation, the security services can talk to each other and access each other's session caches. Federation frequently becomes necessary when single sign-on (SSO) is used, because an SSO token can be verified only by the security service instance that originally generated it.

---

### Federation is not clustering

Federation is not the same thing as clustering. In a federated system, user data is not replicated across different security service instances and there are no fault tolerance features provided.

---

### Example federation scenario

Consider a simple federation scenario consisting of two security domains, each with their own Artix security service instances, as follows:

- *LDAP security domain*—consists of an Artix security service (with `is2.current.server.id` property equal to 1) configured to store user data in an LDAP database. The domain includes any Artix applications that use this Artix security service (ID=1) to verify credentials.  
In this domain, a login server is deployed which enables clients to use single sign-on.
- *Kerberos security domain*—consists of an Artix security service (with `is2.current.server.id` property equal to 2) configured to store user data in a Kerberos database. The domain includes any Artix applications that use this Artix security service (ID=2) to verify credentials.

The two Artix security service instances are federated, using the configuration described later in this section. With federation enabled, it is possible for single sign-on clients to make invocations that cross security domain boundaries.

**Federation scenario**

Figure 30 shows a typical scenario that illustrates how iSF federation might be used in the context of an Artix system.

**Figure 30:** An iSF Federation Scenario

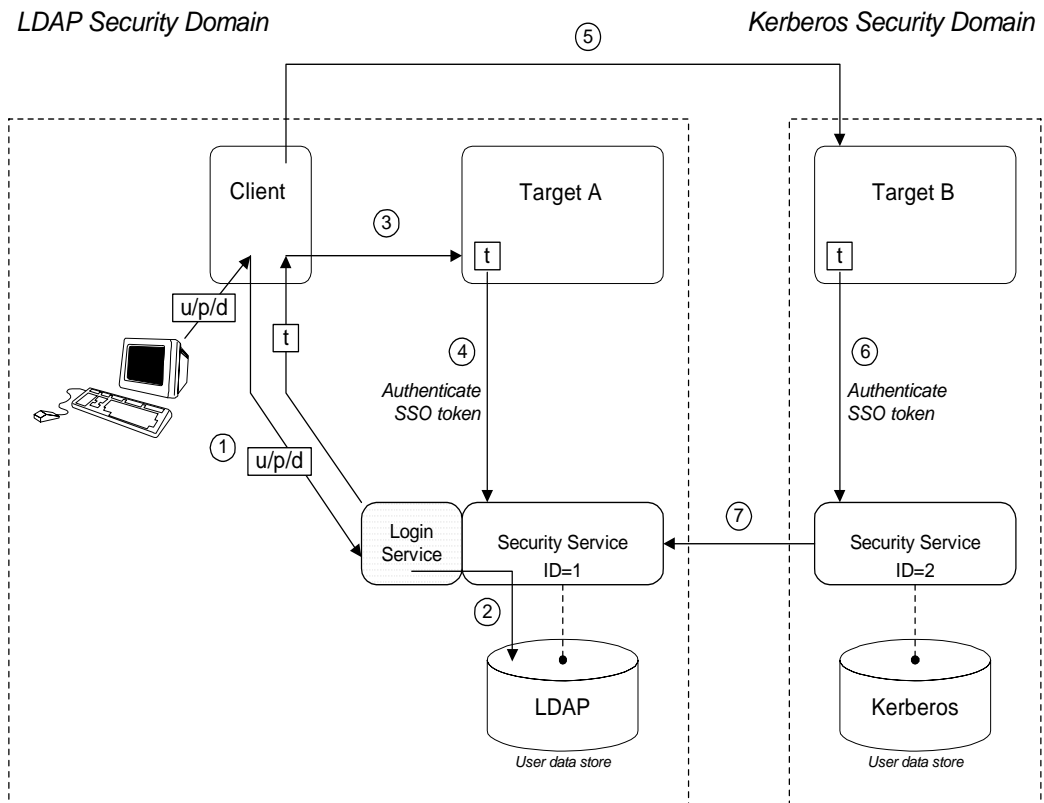

**Federation scenario steps**

The federation scenario in [Figure 30 on page 315](#) can be described as follows:

Stage	Description
1	With single sign-on (SSO) enabled, the client calls out to the login service, passing in the client's GSSUP credentials, $u/p/d$ , in order to obtain an SSO token, $\tau$ .
2	The login service delegates authentication to the Artix security server (ID=1), which retrieves the user's account data from the LDAP backend.
3	The client invokes an operation on the <i>Target A</i> , belonging to the LDAP security domain. The SSO token, $\tau$ , is included in the message.
4	<i>Target A</i> passes the SSO token to the Artix security server (ID=1) to be authenticated. If authentication is successful, the operation is allowed to proceed.
5	Subsequently, the client invokes an operation on the <i>Target B</i> , belonging to the Kerberos security domain. The SSO token, $\tau$ , obtained in step 1 is included in the message.
6	<i>Target B</i> passes the SSO token to the second Artix security server (ID=2) to be authenticated.
7	The second Artix security server examines the SSO token. Because the SSO token is tagged with the first Artix security server's ID (ID=1), verification of the token is delegated to the first Artix security server. The second Artix security server opens an IIOP/TLS connection to the first Artix security service to verify the token.

**Configuring the is2.properties files**

Each instance of the Artix security service should have its own `is2.properties` file. Within each `is2.properties` file, you should set the following:

- `is2.current.server.id`—a unique ID for this Artix security service instance,
- `is2.cluster.properties.filename`—a shared cluster file.
- `is2.sso.remote.token.cached`—a boolean property enables caching of remote token credentials in a federated system.

With caching enabled, the call from one federated security service to another (step 7 of [Figure 30 on page 315](#)) is only necessary to authenticate a token for the first time. For subsequent authentications, the security service (with ID=2) can obtain the token's security data from its own token cache.

For example, the first Artix security server instance from [Figure 30 on page 315](#) could be configured as follows:

```
# iS2 Properties File, for Server ID=1
...
#####
## iSF federation related properties
#####
is2.current.server.id=1
is2.cluster.properties.filename=C:/is2_config/cluster.properties
is2.sso.remote.token.cached=true
...
```

And the second Artix security server instance from [Figure 30 on page 315](#) could be configured as follows:

```
# iS2 Properties File, for Server ID=2
...
#####
## iSF federation related properties
#####
is2.current.server.id=2
is2.cluster.properties.filename=C:/is2_config/cluster.properties
is2.sso.remote.token.cached=true
...
```

**Configuring the cluster properties file**

All the Artix security server instances within a federation should share a cluster properties file. For example, the following extract from the `cluster.properties` file shows how to configure the pair of embedded Artix security servers shown in [Figure 30 on page 315](#).

```
# Advertise the locations of the security services in the cluster.
com.iona.security.common.securityInstanceURL.1=corbaloc:it_iops:1.2@security_ldap1:5001/IT_SecurityService
com.iona.security.common.securityInstanceURL.2=corbaloc:it_iops:1.2@security_ldap2:5002/IT_SecurityService
```

This assumes that the first security service (ID=1) runs on host `security_ldap1` and IP port 5001; the second security service (ID=2) runs on host `security_ldap2` and IP port 5002. To discover the appropriate host and port settings for the security services, check the `plugins:security:iiop_tls` settings in the relevant configuration scope in the relevant Artix configuration file for each federated security service.

The `securityInstanceURL.ServerID` variable advertises the location of a security service in the cluster. Normally, the most convenient way to set these values is to use the `corbaloc` URL format.

---

## Failover—C++ Runtime

---

### Overview

To support *high availability* of the Artix security service, Artix implements the following features:

- *Failover*—the security service is contacted using an IOR that contains the address of *every* security service in a cluster. Hence, if one of the services in the cluster crashes, or otherwise becomes unavailable, an application can automatically try one of the alternative addresses listed in the IOR.

This subsection describes how to configure failover.

**Failover scenario**

**Example 31** shows a scenario for a highly available Artix security service that consists of a cluster of three security services. The security services run on separate hosts, `security01`, `security02`, and `security03` respectively, and all of the services rely on the same third-party LDAP database to store their user data.

**Figure 31:** Failover Scenario for a Cluster of Three Security Services

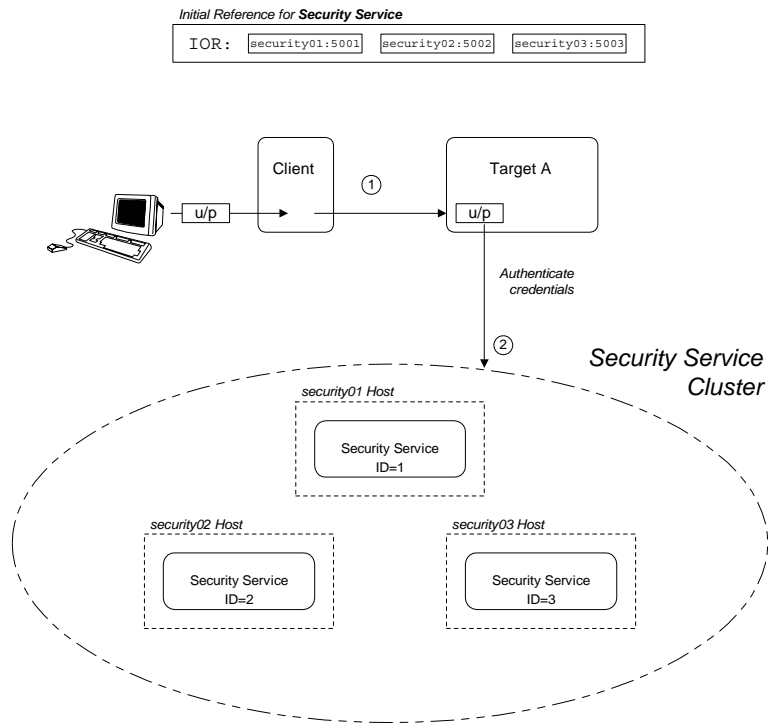

In this scenario, it is assumed that both the client and the target application are configured to perform *random load balancing* over the security services in the cluster (see “[Client Load Balancing—C++ Runtime](#)” on page 327 for details). Each of the security services in the cluster are configured for failover.



**Failover scenario steps**

The interaction of the client and target with the security service cluster shown in [Example 31 on page 320](#) can be described as follows:

Stage	Description
1	The client invokes an operation on the target, sending the username and password (u/p) credentials supplied by the user.
2	The target server checks the u/p credentials received from the client by sending an invocation to the security service cluster. If the target server already has an existing connection with a service in the cluster, it re-uses that connection. Otherwise, the target randomly picks an address from the list of addresses in the <code>IT_SecurityService</code> IOR.

**Configuring the failover cluster**

To configure a cluster of security services that support failover, you need to edit a variety of configuration files, as follows:

- [Configuring the `is2.properties` file.](#)
- [Configuring the cluster properties file.](#)
- [Artix configuration for the first security service.](#)
- [Artix configuration for the second and third security services.](#)

**Configuring the `is2.properties` file**

Each instance of the Artix security service should have its own `is2.properties` file. Within each `is2.properties` file, you should set the following:

- `is2.current.server.id`—a unique ID for this Artix security service instance,
- `is2.cluster.properties.filename`—a shared cluster file.

For example, the first Artix security server instance from [Figure 31 on page 320](#) could be configured as follows:

```
# is2 Properties File, for Server ID=1
...
#####
## iSF federation related properties
#####
is2.current.server.id=1
is2.cluster.properties.filename=C:/is2_config/cluster.properties
...
```

The second and third Artix security services from [Figure 31 on page 320](#) should be configured similarly, except that the `is2.current.server.id` property should be set to 2 and 3 respectively.

### Configuring the cluster properties file

For the three-service cluster shown in [Figure 31 on page 320](#), you could configure the `cluster.properties` file as follows:

```
# Advertise the locations of the security services in the cluster.
com.iona.security.common.securityInstanceURL.1=corbaloc:it_iops:1.2@security01:5001/IT_Security
Service
com.iona.security.common.securityInstanceURL.2=corbaloc:it_iops:1.2@security02:5002/IT_Security
Service
com.iona.security.common.securityInstanceURL.3=corbaloc:it_iops:1.2@security03:5003/IT_Security
Service
```

This file defines the following settings:

- `securityInstanceURL.ServerID`—advertises the location of a security service in the cluster. Normally, the most convenient way to set these values is to use the `corbaloc` URL format.

## Artix configuration for the first security service

**Example 51** shows the details of the Artix configuration for the first Artix security service in the cluster. To configure this security service to support failover, you must ensure that the security service's IOR contains a list addresses for all of the services in the cluster.

### Example 51: Artix Security Service Configuration for Failover

```

# Artix Configuration File
1 initial_references:IT_SecurityService:reference =
  "corbaloc:it_iops:1.2@security01:5001,it_iops:1.2@security0
  2:5002,it_iops:1.2@security03:5003/IT_SecurityService";

artix_services {
  ...
2  principal_sponsor:use_principal_sponsor = "true";
  principal_sponsor:auth_method_id = "pkcs12_file";
  principal_sponsor:auth_method_data = ["filename=PKCS12File",
  "password_file=CertPasswordFile"];

  policies:client_secure_invocation_policy:requires =
  ["Confidentiality", "EstablishTrustInTarget",
  "DetectMisordering", "DetectReplay", "Integrity"];

  policies:client_secure_invocation_policy:supports =
  ["Confidentiality", "EstablishTrustInClient",
  "EstablishTrustInTarget", "DetectMisordering",
  "DetectReplay", "Integrity"];

  security {
    ...
3    plugins:security:iiop_tls:addr_list = ["security01:5001",
  "+security02:5002", "+security03:5003"];
4    plugins:security:iiop_tls:host = "security01";
    plugins:security:iiop_tls:port = "5001";

5    plugins:java_server:system_properties =
  ["org.omg.CORBA.ORBClass=com.ion.corba.art.artimpl.ORBImpl",
  "org.omg.CORBA.ORBSingletonClass=com.ion.corba.art.artimpl.O
  RBSingleton", "is2.properties=SecurityPropertiesDir/security01
  .is2.properties", "java.endorsed.dirs=ArtixInstallDir/cxx_java
  /lib/endorsed"];
    policies:iiop_tls:target_secure_invocation_policy:requires
  = ["Integrity", "Confidentiality", "DetectReplay",
  "DetectMisordering", "EstablishTrustInClient"];
  
```

**Example 51:** *Artix Security Service Configuration for Failover*

```

        policies:iiop_tls:target_secure_invocation_policy:supports
= ["Integrity", "Confidentiality", "DetectReplay",
  "DetectMisordering", "EstablishTrustInTarget",
  "EstablishTrustInClient"];
        ...
    };
};

```

The preceding Artix configuration can be explained as follows:

1. The `IT_SecurityService` initial reference is read by Artix applications to locate the cluster of Artix security services. The initial reference is provided in the form of a `corbaloc` URL, which contains the addresses of all of the security services in the cluster. The `corbaloc` URL for the security service cluster has the following general form:

```
corbaloc:ListOfAddresses/IT_SecurityService
```

Where `ListOfAddresses` is a comma-separated list of protocol/address combinations. For each security service in the cluster, you need to make an entry in the comma-separated address list, as follows:

```
it_iiopts:1.2@Hostname:Port
```

Where `Hostname` is the host where the security service is running and `Port` is the IP port where the security service listens for connections.

2. The Artix security service picks up most of its SSL/TLS security settings from the `artix_services` scope. In particular, the default configuration of the security service uses the X.509 certificate specified by the `principal_sponsor` settings in this scope.
3. The `plugins:security:iiop_tls:addr_list` variable lists the addresses of all of the security services in the cluster.

The first entry, *not* prefixed by a `+` sign, specifies the address of the current security service instance. The remaining entries, prefixed by a `+` sign, specify the addresses of the other services in the cluster.

The `+` sign indicates that an entry affects only the contents of the generated IOR; it does not affect the security service's listening port.

4. The `plugins:security:iiop_tls:host` and `plugins:security:iiop_tls:port` settings specify the listening port for this security service instance.
5. Edit the `is2.properties` entry in the `plugins:java_server:system_properties` list to specify the location of the properties file used by this security service instance (see [“Configuring the `is2.properties` files” on page 317](#)). In this example, the properties file is called `security01.is2.properties`.

### Artix configuration for the second and third security services

The Artix configurations for the second and third security services in the cluster are similar to the configuration for the first one, except that the address details and the location of the `is2.properties` file must be modified appropriately.

For example, the second security service’s configuration would be modified as highlighted in the following example:

```
# Artix Configuration File
artix_services
{
  ...
  security_02 {
    ...
    plugins:security:iiop_tls:addr_list = ["security02:5002",
"+security03:5003", "+security01:5001"];
    plugins:security:iiop_tls:host = "security02";
    plugins:security:iiop_tls:port = "5002";

    plugins:java_server:system_properties =
["org.omg.CORBA.ORBClass=com.ion.corba.art.artimpl.ORBImpl",
"org.omg.CORBA.ORBSingletonClass=com.ion.corba.art.artimpl.ORBSingleton",
"is2.properties=SecurityPropertiesDir/security02.is2.properties",
"java.endorsed.dirs=ArtixInstallDir/cxx_java/lib/endorsed"];
    ...
  };
};
```

Where the name of the configuration scope for the second security service is `artix_services.security_02`. The `plugins:security:iiop_tls:addr_list`, `plugins:security:iiop_tls:host`, and `plugins:security:iiop_tls:port`

configuration variables are modified so that the listening host and port are configured as `security02` and `5002` respectively. The `is2.properties` property is modified to point at the second security service's property file, `security02.is2.properties`.

---

## Client Load Balancing—C++ Runtime

---

### Overview

When you use a clustered security service, it is important to configure all of the secure applications in the system (clients and servers) to perform *client load balancing* (in this context, *client* means a client of the Artix security service and thus includes ordinary Artix servers as well). This ensures that the client load is evenly spread over all of the security services in the cluster. Client load balancing is disabled by default.

### Configuration for load balancing

[Example 52](#) shows an outline of the configuration for a client of a security service cluster. Such clients must be configured to use random load balancing to ensure that the load is spread evenly over the servers in the cluster. The settings highlighted in bold should be added to the application's configuration scope.

#### **Example 52:** *Configuration for Client of a Security Service Cluster*

```
# Artix Configuration File
...
load_balanced_app {
    ...
    initial_references:IT_SecurityService:reference =
"corbaloc:it_iops:1.2@security01:5001,it_iops:1.2@security0
2:5002,it_iops:1.2@security03:5003/IT_SecurityService";
    ...
    plugins:asp:enable_security_service_load_balancing = "true";
    policies:iiop_tls:load_balancing_mechanism = "random";
    policies:asp:load_balancing_policy = "per-server";
};
```

### Security service corbaloc URL

The `IT_SecurityService` initial reference is specified as a corbaloc URL. The corbaloc URL includes the addresses for all of the security services in the cluster—see [“Artix configuration for the first security service” on page 323](#) for details of how to construct this corbaloc URL.

---

**Client load balancing mechanism**

The client load balancing mechanism is selected by setting the `policies:iiop_tls:load_balancing_mechanism` variable. Two mechanisms are supported, as follows:

- `random`—choose one of the addresses embedded in the IOR at random (this is the default).

**Note:** This is the only mechanism suitable for use in a deployed system.

- `sequential`—choose the first address embedded in the IOR, moving on to the next address in the list only if the previous address could not be reached.

In general, this mechanism is *not* recommended for deployed systems, because it usually results in all of the client applications connecting to the first cluster member. This mechanism can sometimes be useful for running tests (because the order in which addresses are chosen is deterministic).

---

**Client load balancing policy**

The client load balancing policy is selected by setting the `policies:asp:load_balancing_policy` variable. Two policies are supported, as follows:

- `per-server`—(*the default*) after selecting a particular security service from the cluster, the client remains connected to that security service instance.
- `per-request`—for each new request, the Artix security plug-in selects and connects to a new security service node (in accordance with the algorithm specified by `policies:iiop_tls:load_balancing_mechanism`).

**Note:** The process of re-establishing a secure connection with every new request imposes a significant performance overhead. Therefore, the `per-request` policy value is *not* recommended for most deployments.



---

**Note on the use of a corbaloc URL for the initial reference**

Specifying the security service IOR as a corbaloc URL has a subtle impact on the semantics of connection establishment, as detailed here.

Internally, Artix converts the corbaloc URL into a multi-profile IOR, where each profile contains a single IOR component with the address details for one security service. This contrasts with the structure of an IOR created directly by a security service, which consists of a single profile containing multiple IOR components. These IORs are treated slightly differently by Artix.

When an Artix program attempts to establish a connection to the security service using a corbaloc URL, the connection establishment is a two-step process:

1. Initially, Artix attempts to send a message to the *first* address appearing in the corbaloc URL. If that connection attempt fails, Artix moves on to the next address in the corbaloc URL, trying each address in sequence until a connection attempt succeeds.

**Note:** In this initial step, Artix always starts by attempting to contact the *first* address in the corbaloc URL. That is, Artix does not load-balance over multiple profiles in an IOR.

2. In reply to the message sent in step 1, the contacted security service sends back a *multi-component IOR*, containing the addresses of all the security services in the cluster (this exploits a feature of the GIOP protocol that allows CORBA servers to redirect incoming connections). When the Artix program receives the multi-component IOR, it makes a renewed attempt to contact a security service using the IOR it has just received.

Because Artix supports load balancing over the addresses in a multi-component IOR, the Artix security plug-in can now randomly pick one of the IOR components (assuming that the `random` load balancing mechanism is selected) and connect to the address contained therein.

---

# Additional Security Configuration

## Overview

---

This section describes how to configure optional features of the Artix security server, such as single sign-on and the authorization manager. These features can be combined with any iSF adapter type.

---

## In this section

This section contains the following subsections:

<a href="#">Configuring Single Sign-On Properties</a>	<a href="#">page 331</a>
<a href="#">Configuring the Log4J Logging</a>	<a href="#">page 333</a>

---

## Configuring Single Sign-On Properties

---

### Overview

The IONA security framework provides an optional *single sign-on* (SSO) feature. If you want to use SSO with your applications, you must configure the Artix security service as described in this section. SSO offers the following advantages:

- User credentials can easily be propagated between applications in the form of an SSO token.
- Performance is optimized, because the authentication step only needs to be performed once within a distributed system.
- Because the user's session is tracked centrally by the Artix security service, it is possible to impose timeouts on the user sessions and these timeouts are effective throughout the distributed system.

### SSO tokens

The Artix security service generates an SSO token in response to an authentication operation. The SSO token is a compact key that the Artix security service uses to access a user's session details, which are stored in a cache.

### SSO properties

[Example 53](#) shows the iS2 properties needed for SSO:

#### Example 53: *Single Sign-On Properties*

```
# iS2 Properties File
...
#####
## Single Sign On Session Info
#####
1 is2.sso.enabled=yes
2 is2.sso.session.timeout=6000
3 is2.sso.session.idle.timeout=300
4 is2.sso.cache.size=10000
```

The SSO properties are described as follows:

1. Setting this property to `yes` enables single sign-on.
2. The SSO session timeout sets the lifesaving of SSO tokens, in units of seconds. Once the specified time interval elapses, the token expires.

3. The SSO session idle timeout sets the maximum length of time for which an SSO session can remain idle, in units of seconds. If the Artix security service registers no activity against a particular session for this amount of time, the session and its token expire.
4. The size of the SSO cache, in units of number of sessions.

---

## Configuring the Log4J Logging

---

### Overview

log4j is a third-party toolkit from the Jakarta project, <http://jakarta.apache.org/log4j>, that provides a flexible and efficient system for capturing logging messages from an application. Because the Artix security service's logging is based on log4j, it is possible to configure the output of iSF logging using a standard log4j properties file.

---

### log4j documentation

For complete log4j documentation, see the following Web page:  
<http://jakarta.apache.org/log4j/docs/documentation.html>

---

### Enabling log4j logging

To enable log4j logging, specify the location of the log4j properties file in the `is2.properties` file as follows:

```
# iS2 Properties File, for Server ID=1
...
#####
## log4j Logging
#####
log4j.configuration=C:/is2_config/log4j.properties
...
```

---

### Configuring the log4j properties file

The following example shows how to configure the log4j properties to perform basic logging. In this example, the lowest level of logging is switched on (`DEBUG`) and the output is sent to the console screen.

```
# log4j Properties File
log4j.rootCategory=DEBUG, A1

# A1 is set to be a ConsoleAppender.
log4j.appender.A1=org.apache.log4j.ConsoleAppender

# A1 uses PatternLayout.
log4j.appender.A1.layout=org.apache.log4j.PatternLayout
log4j.appender.A1.layout.ConversionPattern=%-4r [%t] %-5p %c %x
- %m%n
```

### Redirecting log4j to an Artix local log stream

You can optionally redirect the log4j log stream to the Artix local log stream. To enable this feature, set `plugins:security:log4j_to_local_log_stream` to `true` in the Artix configuration file.

For example, you can configure the Artix security service to send log4j logging to the local log stream, as follows:

```
# Artix Configuration File
security_service
{
  orb_plugins = ["local_log_stream", "iiop_profile", "giop",
               "iiop_tls"];
  plugins:security:log4j_to_local_log_stream = "true";

  # Log all log4j messages at level WARN and above
  event_log:filters = ["IT_SECURITY=WARN+ERROR+FATAL"];
  ...
};
```

You must ensure that the `local_log_stream` plug-in is present in the `orb_plugins` list and the log4j logging level can be set using the Artix event log filters mechanism. The `event_log:filters` setting in the preceding example is equivalent to setting `log4j.rootCategory=WARN` in the log4j properties file.

# Managing Users, Roles and Domains

*The Artix security service provides a variety of adapters that enable you to integrate the Artix Security Framework with third-party enterprise security products. This allows you to manage users and roles using a third-party enterprise security product.*

---

**In this chapter**

This chapter discusses the following topics:

<a href="#">Introduction to Domains and Realms</a>	<a href="#">page 336</a>
<a href="#">Managing a File Security Domain</a>	<a href="#">page 344</a>
<a href="#">Managing an LDAP Security Domain</a>	<a href="#">page 349</a>

---

# Introduction to Domains and Realms

## Overview

---

This section introduces the concepts of an Artix security domain and an Artix authorization realm, which are fundamental to the administration of the Artix Security Framework. Within an Artix security domain, you can create user accounts and within an Artix authorization realm you can assign roles to users.

## In this section

---

This section contains the following subsections:

<a href="#">Artix security domains</a>	<a href="#">page 337</a>
<a href="#">Artix Authorization Realms</a>	<a href="#">page 339</a>



---

## Artix security domains

---

### Overview

This subsection introduces the concept of an Artix security domain.

---

### Domain architecture

Figure 32 shows the architecture of an Artix security domain. The Artix security domain is identified with an enterprise security service that plugs into the Artix security service through an iSF adapter. User data needed for authentication, such as username and password, are stored within the enterprise security service. The Artix security service provides a central access point to enable authentication within the Artix security domain.

**Figure 32:** *Architecture of an Artix security domain*

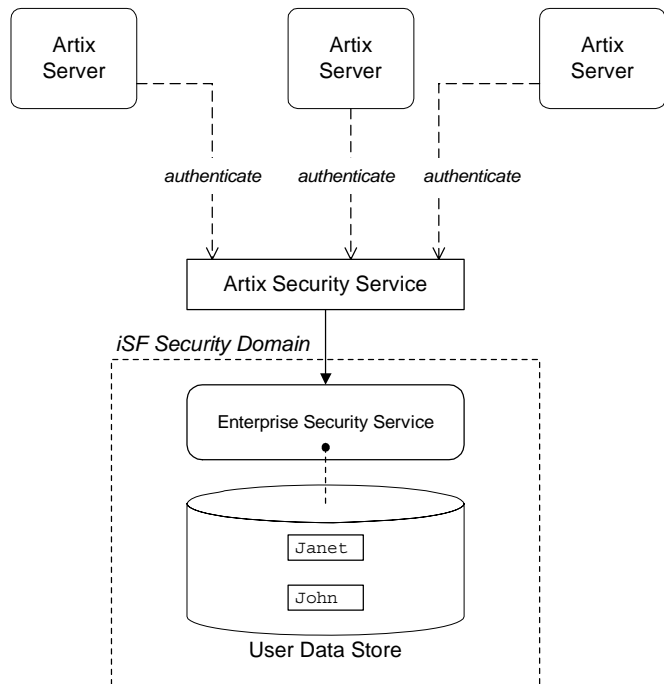

---

**Artix security domain**

An *Artix security domain* is a particular security system, or namespace within a security system, designated to authenticate a user.

Here are some specific examples of Artix security domains:

- LDAP security domain—authentication provided by an LDAP security backend, accessed through the Artix security service.

---

**Creating an Artix security domain**

Effectively, you create an Artix security domain by configuring the Artix security service to link to an enterprise security service through an iSF adapter (such as an LDAP adapter). The enterprise security service is the implementation of the Artix security domain.

---

**Creating a user account**

User account data is stored in a third-party enterprise security service. Hence, you should use the standard tools from the third-party enterprise security product to create a user account.

For a simple example, see [“Managing a File Security Domain” on page 344](#).

---

## Artix Authorization Realms

---

### Overview

This subsection introduces the concept of an Artix authorization realm and role-based access control, explaining how users, roles, realms, and servers are interrelated.

---

### Artix authorization realm

An *Artix authorization realm* is a collection of secured resources that share a common interpretation of role names. An authenticated user can have different roles in different realms. When using a resource in realm  $\mathbb{R}$ , only the user's roles in realm  $\mathbb{R}$  are applied to authorization decisions.

---

### Role-based access control

The Artix Security Framework supports a *role-based access control* (RBAC) authorization scheme. Under RBAC, authorization is a two step process, as follows:

1. User-to-role mapping—every user is associated with a set of roles in each realm (for example, `guest`, `administrator`, and so on, in a realm, `Engineering`). A user can belong to many different realms, having a different set of roles in each realm.

The user-to-role assignments are managed centrally by the Artix security service, which returns the set of realms and roles assigned to a user when required.

2. Role-to-permission mapping (or action-role mapping)—in the RBAC model, permissions are granted to *roles*, rather than directly to users. The role-to-permission mapping is performed locally by a server, using data stored in local access control list (ACL) files. For example, Artix servers in the Artix security framework use an XML action-role mapping file to control access to WSDL port types and operations.

## Servers and realms

From a server's perspective, an Artix authorization realm is a way of grouping servers with similar authorization requirements. [Figure 33](#) shows two Artix authorization realms, `Engineering` and `Finance`, each containing a collection of server applications.

**Figure 33:** *Server View of Artix authorization realms*

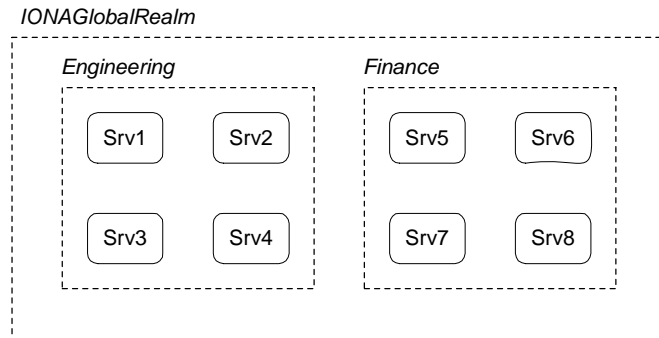

## Adding a server to a realm—Java runtime

To add an Artix server to a realm, where the server is implemented using the Java runtime, identify the relevant authorization element in your XML configuration file and update its `authorizationRealm` attribute.

For example, if the authorization element is `security:WSSUsernameTokenAuthServerConfig`, you can set the Artix authorization realm to `Engineering` as follows:

```

<jaxws:endpoint name="{PortNamespace}PortName"
  createdFromAPI="true">
  <jaxws:features>
    <security:WSSUsernameTokenAuthServerConfig
      aclURL="file:ACLFileLocation"
      aclServerName="ServerName"
      authorizationRealm="Engineering"
    />
  </jaxws:features>
</jaxws:endpoint>
  
```

### Adding a server to a realm—C++ runtime

To add an Artix server to a realm, where the server is implemented using the C++ runtime, add or modify the `plugins:asp:authorization_realm` configuration variable within the server's configuration scope (in your Artix configuration file).

For example, if your server's configuration is defined in the `my_server_scope` scope, you can set the Artix authorization realm to `Engineering` as follows:

```
# Artix configuration file
...
my_server_scope {
    plugins:asp:authorization_realm = "Engineering";
    ...
};
```

### Roles and realms

From the perspective of role-based authorization, an Artix authorization realm acts as a namespace for roles. For example, [Figure 34](#) shows two Artix authorization realms, `Engineering` and `Finance`, each associated with a set of roles.

**Figure 34:** *Role View of Artix authorization realms*

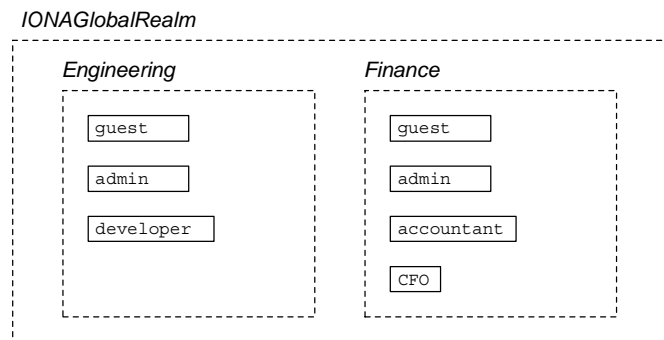

### Creating realms and roles

Realms and roles are usually administered from within the enterprise security system that is plugged into the Artix security service through an adapter. Not every enterprise security system supports realms and roles, however.

For example, in the case of a security file connected to a file adapter (a demonstration adapter provided by IONA), a realm or role is implicitly created whenever it is listed amongst a user's realms or roles.

### Assigning realms and roles to users

The assignment of realms and roles to users is administered from within the enterprise security system that is plugged into the Artix security service. For example, [Figure 35](#) shows how two users, Janet and John, are assigned roles within the `Engineering` and `Finance` realms.

- Janet works in the engineering department as a developer, but occasionally logs on to the `Finance` realm with guest permissions.
- John works as an accountant in finance, but also has guest permissions with the `Engineering` realm.

**Figure 35:** *Assignment of Realms and Roles to Users Janet and John*

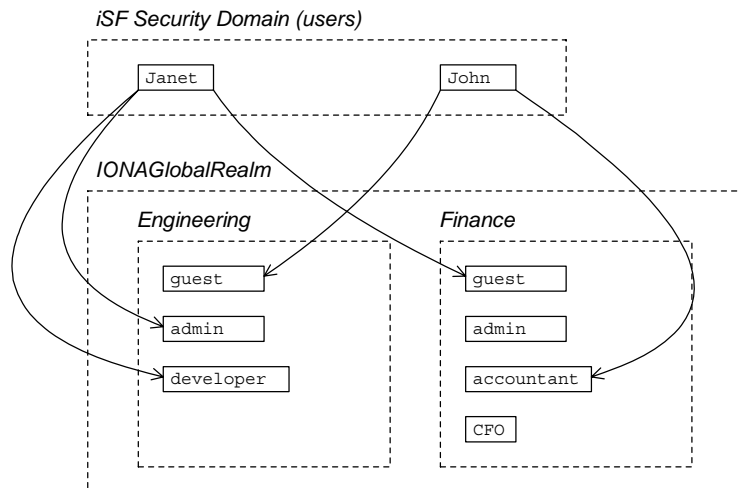

## Special realms and roles

---

The following special realms and roles are supported by the Artix Security Framework:

- `IONAGlobalRealm` realm—a special realm that encompasses every Artix authorization realm. Roles defined within the `IONAGlobalRealm` are valid within every Artix authorization realm.
- `UnauthenticatedUserRole`—a special role that can be used to specify actions accessible to an unauthenticated user (in an action-role mapping file). An unauthenticated user is a remote user without credentials (that is, where the client is not configured to send GSSUP credentials).

Actions mapped to the `UnauthenticatedUserRole` role are also accessible to authenticated users.

The `UnauthenticatedUserRole` can be used *only* in action-role mapping files.

---

# Managing a File Security Domain

---

## Overview

The file security domain is active if the Artix security service has been configured to use the iSF file adapter (see [“Configuring the File Adapter” on page 293](#)). The main purpose of the iSF file adapter is to provide a lightweight security domain for demonstration purposes and small deployments. A large deployed system, however, should use one of the other adapters (LDAP or custom) instead.

**Note:** The file adapter is a simple adapter that does *not* scale well for large enterprise applications. IONA supports the use of the file adapter in a production environment, but the number of users is limited to 200.

## Location of file

The location of the security information file is specified by the `com.iona.isp.adapter.file.param.filename` property in the Artix security service's `is2.properties` file.

## Example

[Example 54](#) is an extract from a sample security information file that shows you how to define users, realms, and roles in a file security domain.

### Example 54: Sample Security Information File for an iSF File Domain

```

1 <?xml version="1.0" encoding="utf-8" ?>
2 <ns:securityInfo xmlns:ns="urn:www-xmlbus-com:simple-security">
3   <users>
4     <user name="IONAAdmin" password="admin"
      description="Default IONA admin user">
      <realm name="IONA" description="All IONA applications"/>
    </user>
    <user name="admin" password="admin" description="Old admin
      user; will not have the same default privileges as
      IONAAdmin.">
      <realm name="Corporate">
        <role name="Administrator"/>
      </realm>
    </user>
    <user name="alice" password="dost1234">

```



**Example 54:** *Sample Security Information File for an iSF File Domain*

```

5  <realm name="Financials"
      description="Financial Department">
      <role name="Manager" description="Department Manager" />
      <role name="Clerk"/>
    </realm>
  </user>
  <user name="bob" password="dost1234">
    <realm name="Financials">
      <role name="Clerk"/>
    </realm>
  </user>
</users>
</ns:securityInfo>

```

1. The `<ns:securityInfo>` tag can contain a nested `<users>` tag.
2. The `<users>` tag contains a sequence of `<user>` tags.
3. Each `<user>` tag defines a single user. The `<user>` tag's `name` and `password` attributes specify the user's username and password. Instead of specifying the password in plaintext, you also have the option of specifying a password hash using the `password_hash` attribute—see [“Password hashing” on page 347](#) for details.

Within the scope of the `<user>` tag, you can list the realms and roles with which the user is associated.

4. When a `<realm>` tag appears within the scope of a `<user>` tag, it implicitly defines a realm and specifies that the user belongs to this realm. A `<realm>` must have a `name` and can optionally have a `description` attribute.
5. A realm can optionally be associated with one or more roles by including `role` elements within the `<realm>` scope.

### Certificate-based authentication for the file adapter

When performing certificate-based authentication for the CORBA binding, the file adapter compares the certificate to be authenticated with a cached copy of the user's certificate.

To configure the file adapter to support X.509 certificate-based authentication for the CORBA binding, perform the following steps:

1. Cache a copy of each user's certificate, *CertFile.pem*, in a location that is accessible to the file adapter. The certificate must be in PEM format.
2. Specify which one of the fields from the certificate's subject DN should contain the user's name (user ID) by setting the `com.ionas.isp.adapter.file.param.userIDInCert` property in the Artix security server's `is2.properties` file.

For example, to use the Common Name (CN) from the certificate's subject DN as the user name, add the following setting to the `is2.properties` file:

```
# Artix Security Server Properties File
com.ionas.isp.adapter.file.param.userIDInCert=CN
```

3. In the security information file, make the following type of entry for each user with a certificate:

#### Example 55: File Adapter Entry for Certificate-Based Authentication

```
...
<user name="FieldFromSubjectDN" certificate="CertFile.pem"
  description="User certificate">
  <realm name="RealmName">
    ...
  </realm>
</user>
```

The user name, *FieldFromSubjectDN*, is derived from the user's certificate by extracting the relevant field from the subject DN of the X.509 certificate (for DN terminology, see [“ASN.1 and Distinguished Names” on page 731](#)). The field to extract from the subject DN is specified as described in the preceding step.

The `certificate` attribute specifies the location of this user's X.509 certificate, `CertFile.pem`.

## Password hashing

Storing passwords in plaintext format in the security information file is not ideal, from a security perspective. In particular, it is likely that several different users would need to update the security information file. Hence, using operating system permissions to block read/write access to this file is not a practical solution.

The problem of plaintext passwords can be solved using *password hashing*. Instead of storing passwords in plaintext, you can generate a secure hash key based on the original password. In the security information file, replace the `password` attribute with the `password_hash` attribute to store the password hash—for example:

```
<ns:securityInfo xmlns:ns="urn:www-xmlbus-com:simple-security">
  ...
  <user name="alice" password_hash="HashKey">
    ...
  </user>
  ...
</ns:securityInfo>
```

Where `HashKey` is generated from the original password using the Artix `it_pw_hash` utility.

## it\_pw\_hash utility

The Artix `it_pw_hash` utility is a command-line utility for converting plaintext passwords to password hashes. The hashing algorithm used is SHA-1. There are three different ways of using the utility, as follows:

- *Convert all passwords to hashes*—to convert all of the passwords in a security information file to password hashes (replacing every `password` attribute by a corresponding `password_hash` attribute), enter the following at a command prompt:

```
it_pw_hash -update_all -password_file SecurityFile
[-out_file NewSecurityFile] [-v]
```

Where `SecurityFile` is the path to the security information file containing password data in plaintext. By default, the original `SecurityFile` is overwritten with a version that uses `password_hash`

attributes. However, you can optionally use the `-out_file` flag to specify an alternative file for the output, in which case the original file is left unchanged. The optional `-v` flag switches on verbose logging.

- *Convert a single password to a hash*—to convert a single password in a security information file to a password hash (replacing the user's `password` attribute by a corresponding `password_hash` attribute), enter the following at a command prompt:

```
it_pw_hash -update_password -user Username -password_file  
SecurityFile [-out_file NewSecurityFile] [-v]
```

Where `Username` specifies the name of the user (matching the `name` attribute in one of the `user` elements) whose password is to be changed into hash format.

- *Reset a password hash*—to reset the password hash value for a single user, enter the following at a command prompt:

```
it_pw_hash -set_password -user Username -password_file  
SecurityFile [-out_file NewSecurityFile] [-v]
```

In this case, the command prompts you to enter a new password for the user and generates a corresponding password hash, which is then assigned to the `password_hash` attribute.

---

# Managing an LDAP Security Domain

---

## Overview

The Lightweight Directory Access Protocol (LDAP) can serve as the basis of a database that stores users, groups, and roles. There are many implementations of LDAP and the Artix security service's LDAP adapter can integrate with any LDAP v.3 implementation.

*Please consult documentation from your third-party LDAP implementation for detailed instructions on how to administer users and roles within LDAP.*

---

## Configuring the LDAP adapter

A prerequisite for using LDAP within the Artix Security Framework is that the Artix security service be configured to use the LDAP adapter.

See [“Configuring the LDAP Adapter” on page 295](#).

---

## Certificate-based authentication for the LDAP adapter

When performing certificate-based authentication, the LDAP adapter compares the certificate to be authenticated with a cached copy of the user's certificate.

To configure the LDAP adapter to support X.509 certificate-based authentication, perform the following steps:

1. Cache a copy of each user's certificate, `CertFile.pem`, in a location that is accessible to the LDAP adapter. The certificate must be in PEM format.
2. The user's name, `CNfromSubjectDN`, is derived from the certificate by taking the Common Name (CN) from the subject DN of the X.509 certificate (for DN terminology, see [“ASN.1 and Distinguished Names” on page 731](#)).
3. Make (or modify) an entry in your LDAP database with the username, `CNfromSubjectDN`, and specify the location of the cached certificate.



# Managing Access Control Lists

*The Artix Security Framework defines access control lists (ACLs) for mapping roles to resources.*

---

**In this chapter**

This chapter discusses the following topics:

<a href="#">Overview of Artix ACL Files</a>	<a href="#">page 352</a>
<a href="#">ACL File Format</a>	<a href="#">page 353</a>
<a href="#">Generating ACL Files</a>	<a href="#">page 357</a>
<a href="#">Deploying ACL Files</a>	<a href="#">page 360</a>

# Overview of Artix ACL Files

## Action-role mapping file

The action-role mapping file is an XML file that specifies which user roles have permission to perform specific actions on the server (that is, invoking specific WSDL operations).

## Deployment scenarios

Artix supports the following deployment scenario for ACL files:

- [Local ACL file](#).

## Local ACL file

In the local ACL file scenario, the action-role mapping file is stored on the same host as the server application (see [Figure 36](#)). The application obtains the action-role mapping data by reading the local ACL file.

**Figure 36:** *Locally Deployed Action-Role Mapping ACL File*

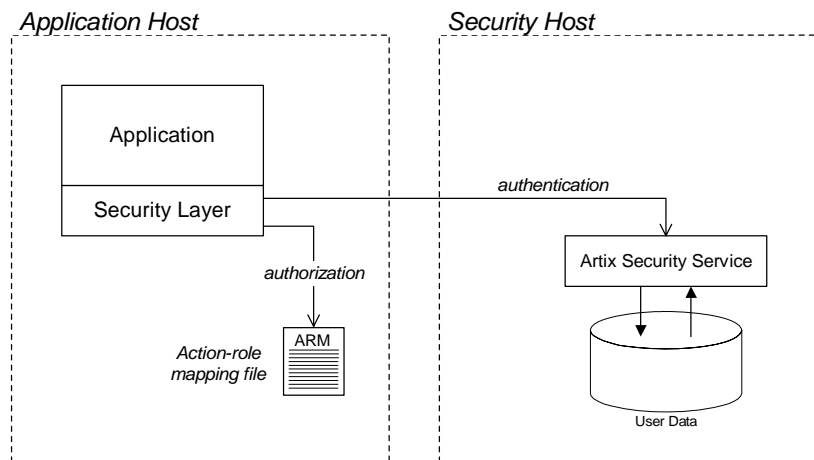

In this case, the location of the ACL file is specified by a setting in the application's `artix.cfg` file.



---

# ACL File Format

## Overview

This subsection explains how to configure the action-role mapping ACL file for Artix applications. Using an action-role mapping file, you can specify that access to WSDL operations is restricted to specific roles.

## Example WSDL

For example, consider how to set the operation permissions for the WSDL port type shown in [Example 56](#).

### Example 56: Sample WSDL for the ACL Example

```
<definitions name="HelloWorldService"
  targetNamespace="http://xmlbus.com/HelloWorld" ... >
  ...
  <portType name="HelloWorldPortType">
    <operation name="greetMe">
      <input message="tns:greetMe" name="greetMe"/>
      <output message="tns:greetMeResponse"
        name="greetMeResponse"/>
    </operation>
    <operation name="sayHi">
      <input message="tns:sayHi" name="sayHi"/>
      <output message="tns:sayHiResponse"
        name="sayHiResponse"/>
    </operation>
  </portType>
  ...
</definitions>
```

**ACL file preamble**

Although the XML format of the Java runtime ACL file is essentially the same as the format of the C++ runtime ACL file, there is a slight difference in the preamble. This is because the Java runtime ACL file is validated against an *XML schema*, whereas the C++ runtime ACL file is validated against a *Document Type Definition (DTD)*.

**Java runtime ACL file preamble**

A Java runtime ACL file—which validates against an XML schema—has the following preamble:

```
<secure-system
  xmlns="http://schemas.iona.com/security/acl"
  xmlns:xsi="http://www.w3.org/2001/XMLSchema-instance"
  xsi:schemaLocation="..." >
  ...
</secure-system>
```

**C++ runtime ACL file preamble**

A C++ runtime ACL file—which validates against a DTD—has the following preamble:

```
<?xml version="1.0" encoding="UTF-8"?>
<!DOCTYPE secure-system SYSTEM "actionrolemapping.dtd">
<secure-system>
  ...
</secure-system>
```

**Example action-role mapping**

[Example 57](#) shows how you might configure an action-role mapping file for the `HelloWorldPortType` port type given in the preceding [Example 56 on page 353](#), where the preamble is suitable for a C++ runtime application.

**Example 57: Artix Action-Role Mapping Example**

```

1 <?xml version="1.0" encoding="UTF-8"?>
2 <!DOCTYPE secure-system SYSTEM "actionrolemapping.dtd">
3 <secure-system>
4   <action-role-mapping>
5     <server-name>secure_artix.demos.hello_world</server-name>
     <interface>
       <name>http://xmlbus.com/HelloWorld:HelloWorldPortType</name>
       <action-role>
```

**Example 57:** *Artix Action-Role Mapping Example*

```

6      <action-name>sayHi</action-name>
      <role-name>IONAUserRole</role-name>
    </action-role>
    <action-role>
      <action-name>greetMe</action-name>
      <role-name>IONAUserRole</role-name>
    </action-role>
  </interface>
</action-role-mapping>
</secure-system>

```

The preceding action-role mapping example can be explained as follows:

1. The preamble in this example is suitable for a C++ runtime application—see [“ACL file preamble” on page 354](#).
2. The `<action-role-mapping>` tag contains all of the permissions that apply to a particular server application.
3. The `<server-name>` tag is used to identify the current `action-role-mapping` element (you can have more than one `action-role-mapping` element in an ACL file). The value of the *server name* depends on which Artix runtime you are using, as follows:
  - ◆ *Java runtime*—the server name is selected to match the value of the `aclServerName` attribute in the relevant authorization element in the server’s XML configuration file (for example, see [“Server domain configuration and access control” on page 44](#)).
  - ◆ *C++ runtime*—the server name specifies the BUS name that is used by the server in question. The value of this tag must match the BUS name exactly. The BUS name is usually passed to an Artix server as the value of the `-BUSname` command-line parameter.

**Note:** The BUS name also determines which configuration scopes are read by the server.

4. The `<interface>` tag contains all of the access permissions for one particular WSDL port type.

5. The `<name>` tag identifies a WSDL port type in the format `NamespaceURI:PortTypeName`. That is, the `PortTypeName` comes from a tag, `<portType name="PortTypeName">`, defined in the `NamespaceURI` namespace.

For example, in [Example 56 on page 353](#) the `<definitions>` tag specifies the `NamespaceURI` as `http://xmlbus.com>HelloWorld` and the `PortTypeName` is `HelloWorldPortType`. Hence, the port type name is identified as:

```
<name>http://xmlbus.com/HelloWorld>HelloWorldPortType</name>
```

6. The `sayHi` action name corresponds to the `sayHi` WSDL operation name in the `HelloWorldPortType` port type (from the `<operation name="sayHi">` tag).

## Wildcard character

Artix supports a wildcard mechanism for the `server-name`, `interface name`, and `action-name` elements in an ACL file. The wildcard character, `*`, can be used to match any number of contiguous characters in a server name, interface name, or action name. For example, the access control list shown in [Example 58](#) assigns the `IONAUserRole` role to every action in every interface in every Bus instance.

### Example 58: Wildcard Mechanism in an Access Control List

```
<?xml version="1.0" encoding="UTF-8"?>
<!DOCTYPE secure-system SYSTEM "actionrolemapping.dtd">
<secure-system>
  <action-role-mapping>
    <server-name>*</server-name>
    <interface>
      <name>*</name>
      <action-role>
        <action-name>*</action-name>
        <role-name>IONAUserRole</role-name>
      </action-role>
    </interface>
  </action-role-mapping>
</secure-system>
```

## Action-role mapping DTD

The syntax of the action-role mapping file is defined by the action-role mapping DTD. See [“Action-Role Mapping DTD” on page 737](#) for details.

---

# Generating ACL Files

## Overview

Artix provides a command-line tool, `artix wsdl2acl`, that enables you to generate the prototype of an ACL file directly from a WSDL contract. You can use the `wsdl2acl` subcommand to assign a default role to all of the operations in WSDL contract. Alternatively, if you require more fine-grained control over the role assignments, you can define a *role-properties file*, which assigns roles to individual operations.

## WSDL-to-ACL utility

The `artix wsdl2acl` command-line utility has the following syntax:

```
artix wsdl2acl { -s server-name } WSDL-URL
[-i interface-name] [-r default-role-name]
[-d output-directory] [-o output-file]
[-props role-props-file] [-v] [-?]
```

### Required arguments:

<code>-s server-name</code>	The server's configuration scope from the Artix domain configuration file (the same value as specified to the <code>-BUSname</code> argument when the Artix server is started from the command line).  For example, the <code>basic/hello_world_soap_http</code> demonstration uses the <code>demos.hello_world_soap_http</code> server name.
<code>WSDL-URL</code>	URL location of the WSDL file from which an ACL is generated.

### Optional arguments:

<code>-i interface-name</code>	Generates output for a specific WSDL port type, <code>interface-name</code> . If this option is omitted, output is generated for all of the port types in the WSDL file.
<code>-r default-role-name</code>	Specify the role name that will be assigned to all operations by default. Default is <code>IONAUserRole</code> .  The default role-name is not used for operations listed in a role-properties file (see <code>-props</code> ).

<code>-d output-directory</code>	Specify an output directory for the generated ACL file.
<code>-o output-file</code>	Specify the name of the generated ACL file. Default is <code>WSDLFileRoot-acl.xml</code> , where <code>WSDLFileRoot</code> is the root name of the WSDL file.
<code>-props role-props-file</code>	Specifies a file containing a list of <i>role-properties</i> , where a role-property associates an operation name with a list of roles. Each line of the role-properties file has the following format:  <code>OperationName = Role1, Role2, ...</code>
<code>-v</code>	Display version information for the utility.
<code>-?</code>	Display usage summary for the <code>wsdl2acl</code> subcommand.

**Example of generating an ACL file**

As example of how to generate an ACL file from WSDL, consider the `hello_world.wsdl` WSDL file for the `basic/hello_world_soap_http` demonstration, which is located in the following directory:

```
ArtixInstallDir/cxx_java/samples/basic/hello_world_soap_http/etc
```

The HelloWorld WSDL contract defines a single port type, `Greeter`, and two operations: `greetMe` and `sayHi`. The server name (that is, configuration scope) used by the HelloWorld server is `demo.hello_world_soap_http`.

**Sample role-properties file**

For the HelloWorld WSDL contract, you can define a role-properties file, `role_properties.txt`, that assigns the `FooUser` role to the `greetMe` operation and the `FooUser` and `BarUser` roles to the `sayHi` operation, as follows:

```
greetMe = FooUser
sayHi = FooUser, BarUser
```

**Sample generation command**

To generate an ACL file from the HelloWorld WSDL contract, using the `role_properties.txt` role-properties file, enter the following at a command-line prompt:

```
artix wsdl2acl -s demo.hello_world_soap_http hello_world.wsdl
  -props role_properties.txt
```

**Sample ACL output**

The preceding `artix wsdl2acl` command generates an ACL file, `hello_world-acl.xml`, whose contents are shown in [Example 59](#).

**Example 59:** *ACL File Generated from HelloWorld WSDL Contract*

```
<?xml version="1.0" encoding="UTF-8"?>
<!DOCTYPE secure-system SYSTEM "actionrolemapping.dtd">
<secure-system>
  <action-role-mapping>
    <server-name>demos.hello_world_soap_http</server-name>
    <interface>
      <name>http://www.iona.com/hello_world_soap_http:Greeter</name>
      <action-role>
        <action-name>greetMe</action-name>
        <role-name>FooUser</role-name>
      </action-role>
      <action-role>
        <action-name>sayHi</action-name>
        <role-name>FooUser</role-name>
        <role-name>BarUser</role-name>
      </action-role>
    </interface>
  </action-role-mapping>
</secure-system>
```

---

# Deploying ACL Files

---

## Configuring a local ACL file

To configure an application to load action-role mapping data from a local file, do the following:

1. Save the ACL file together with the Artix action-role mapping DTD file in a convenient location. You can copy the DTD file, `actionrolemapping.dtd`, from the `ArtixInstallDir/cxx_java/samples/security/full_security/etc` directory.
2. *Java runtime*—edit the application's XML configuration file. In the relevant authorization element, update the `aclURL` attribute with the ACL file location and update the `aclServerName` attribute with the server name of the `action-role-mapping` element you want to apply.

For example, if the authorization element is

`security:WSSUsernameTokenAuthServerConfig`, you can update the configuration as follows:

```
<jaxws:endpoint name="{PortNamespace}PortName"
                createdFromAPI="true">
  <jaxws:features>
    <security:WSSUsernameTokenAuthServerConfig
      aclURL="file:ACLFileLocation"
      aclServerName="ServerName"
      authorizationRealm="SelectedRealm"
    />
  </jaxws:features>
</jaxws:endpoint>
```



3. *C++ runtime*—edit the Artix configuration file, initializing the `plugins:is2_authorization:action_role_mapping` configuration variable with the ACL file location.

For example, an program can be initialized to load a local ACL file, `security_admin/action_role_mapping.xml`, using the following configuration:

```
# Artix Configuration File
...
orb_plugins = ["xmlfile_log_stream", "iiop_profile", "giop",
              "iiop_tls", "soap", "http", "artix_security"];

my_server_scope {
    plugins:is2_authorization:action_role_mapping =
        "file:///security_admin/action_role_mapping.xml";
    ...
};
```



# Configuring Servers to Support Authentication— Java Runtime

*This chapter describes how to integrate an Artix server (Java runtime) with the Artix security service, thereby enabling authentication and authorization on the server's endpoints.*

## In this chapter

---

This chapter discusses the following topics:

<a href="#">Connecting to the Artix Security Service</a>	<a href="#">page 364</a>
<a href="#">Selecting Credentials to Authenticate</a>	<a href="#">page 369</a>

# Connecting to the Artix Security Service

## Overview

The first step in integrating an Artix server with the security service is to configure a secure connection between the Artix server and the security service. [Figure 37](#) shows an overview of the server's connection to the security service.

**Figure 37:** Overview of Connecting to the Security Service

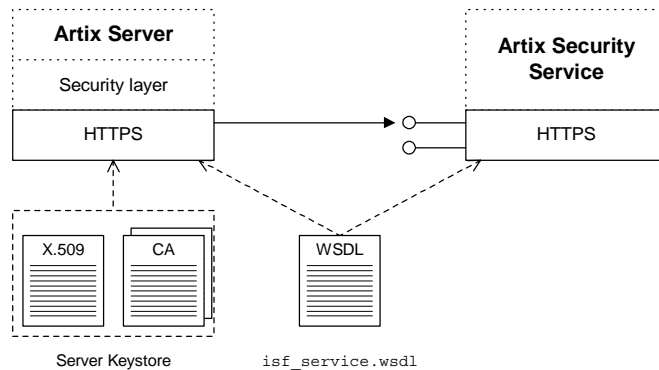

The server communicates with the security service using the SOAP binding and the HTTPS protocol. Connections to the security service are automatically opened by a security handler in the Artix server. The security service itself must be configured to use SOAP/HTTPS, as described in [“Security Service Accessible through HTTPS”](#) on page 282.

## Security service WSDL contract

The interface between the Artix server and the Artix security service is defined by a WSDL contract. A copy of the security service's WSDL contract is provided with the security service demonstrations—for example, the `isf_service.wsdl` file in the `ArtixInstallDir/java/samples/security/authorization/etc` directory.

### Customizing the security service host and IP port

The only part of the security service WSDL contract that you should attempt to modify is the WSDL port for the `IT_ISF.ServiceManagerSOAPService` service. For example, you usually would need to modify the host and IP port specified by the `location` attribute in the `http:address` element of the security service port, as highlighted in [Example 60](#).

#### Example 60: Artix Security Service WSDL Contract

```
<definitions name="isf_service"
  targetNamespace="http://schemas.iona.com/idl/isf_service.idl"
  xmlns="http://schemas.xmlsoap.org/wsdl/"
  xmlns:http="http://schemas.xmlsoap.org/wsdl/http/"
  xmlns:soap="http://schemas.xmlsoap.org/wsdl/soap/"
  xmlns:tns="http://schemas.iona.com/idl/isf_service.idl"
  ... >
  ...
  <service name="IT_ISF.ServiceManagerSOAPService">
    <port binding="tns:IT_ISF.ServiceManagerSOAPBinding"
      name="IT_ISF.ServiceManagerSOAPPort">
      <http:address
        location="https://localhost:59075/services/security/ServiceMa
nager"/>
    </port>
  </service>
</definitions>
```

### Specifying the location of the security service contract

In order for the Artix server to connect to the security service, you must specify the location of the security service contract in the Artix server's XML configuration, as shown in [Example 61](#).

#### Example 61: Specifying the Security Service Contract Location

```
<beans
  xmlns:security="http://schemas.iona.com/soa/security-config"
  ... >
  ...
  <security:IsfClientConfig
    id="it.soa.security"
    IsfServiceWsdLoc="SecurityServiceContractURL"
  />
  ...
</beans>
```

Where *SecurityServiceContractURL* is a URL that points at the security service's WSDL contract—for example, `file:///C:/contracts/secure/isf_service.wsdl`. The `id` attribute is required in order to identify the element internally and must be set as shown.

### Securing the HTTPS connections to the security service

The Artix server's connections to the security service must be secured using the HTTPS protocol, in order to protect the Artix server from eavesdropping and malicious tampering. In the server's XML configuration file, secure the connections to two distinct endpoints in the security service, as shown in [Example 62](#).

#### Example 62: Securing HTTPS Connections to the Security Service

```
<beans
  xmlns:security="http://schemas.iona.com/soa/security-config"
  ... >
  ...
  <!-- Secure HTTP/S communications into ISF Server -->
  <http:conduit
    name="{http://schemas.iona.com/idl/isf_service.idl}IT_ISF.ServiceManagerSOAPPort.http-conduit">
    <http:tlsClientParameters>
      <sec:keyManagers ...>
      <sec:trustManagers ...>
      <sec:cipherSuitesFilter ...>
    </http:tlsClientParameters>
  </http:conduit>
  <http:conduit
    name="{http://schemas.iona.com/idl/isfx_authn_service.idl}IT_ISFX.AuthenticationServicesSOAPPort.http-conduit">
    <http:tlsClientParameters>
      <sec:keyManagers ...>
      <sec:trustManagers ...>
      <sec:cipherSuitesFilter ...>
    </http:tlsClientParameters>
  </http:conduit>
  ...
</beans>
```

The following security service endpoints must be secured by HTTPS:

- {http://schemas.ionas.com/idl/isf\_service.idl}IT\_ISF.ServiceManagerSOAPPoort
- {http://schemas.ionas.com/idl/isfx\_authn\_service.idl}IT\_ISFX.AuthenticationServiceSOAPPoort

Apply *client-side* HTTPS security to these endpoints according to the usual pattern for the Java runtime—see [“Configuring HTTPS and IOP/TLS Authentication” on page 195](#) and [“Configuring HTTPS Cipher Suites—Java Runtime” on page 233](#).

### Example configuration

**Example 63** shows an example of the XML configuration required for connecting to the security service, where the security service WSDL contract is contained in the file, `etc/isf_service.wsdl`.

#### **Example 63:** XML Configuration for Connecting to the Security Service

```
<beans xmlns="http://www.springframework.org/schema/beans"
  xmlns:xsi="http://www.w3.org/2001/XMLSchema-instance"
  xmlns:http="http://cxf.apache.org/transports/http/configuration"
  xmlns:httpj="http://cxf.apache.org/transports/http-jetty/configuration"
  xmlns:jaxws="http://cxf.apache.org/jaxws"
  xmlns:sec="http://cxf.apache.org/configuration/security"
  xmlns:security="http://schemas.ionas.com/soa/security-config"
  xsi:schemaLocation="...">

  <!-- ISF Client config -->
  <security:IsfClientConfig
    id="it.soa.security"
    IsfServiceWsdloc="file:etc/isf_service.wsdl"
  />

  <!-- Secure HTTP/S communications into ISF Server -->
  <http:conduit
    name="{http://schemas.ionas.com/idl/isf_service.idl}IT_ISF.ServiceManagerSOAPPoort.http-conduit"
  >
    <http:tlsClientParameters>
      <sec:keyManagers keyPassword="password">
        <sec:keyStore type="jks" password="password" resource="keys/isf-client.jks"/>
      </sec:keyManagers>
      <sec:trustManagers>
        <sec:keyStore type="jks" password="password" file="keys/isf-client.jks"/>
      </sec:trustManagers>
      <sec:cipherSuitesFilter>
```

**Example 63:** XML Configuration for Connecting to the Security Service

```

        <sec:include>.*_WITH_3DES_.*</sec:include>
        <sec:include>.*_WITH_DES_.*</sec:include>
        <sec:exclude>.*_WITH_NULL_.*</sec:exclude>
        <sec:exclude>.*_DH_anon_.*</sec:exclude>
    </sec:cipherSuitesFilter>
</http:tlsClientParameters>
</http:conduit>
<http:conduit
name="{http://schemas.ionapro.com/idl/isfx_authn_service.idl}IT_ISFX.AuthenticationServiceSOAPPo
rt.http-conduit">
    <http:tlsClientParameters>
        <sec:keyManagers keyPassword="password">
            <sec:keyStore type="jks" password="password" resource="keys/isf-client.jks"/>
        </sec:keyManagers>
        <sec:trustManagers>
            <sec:keyStore type="jks" password="password" file="keys/isf-client.jks"/>
        </sec:trustManagers>
        <sec:cipherSuitesFilter>
            <sec:include>.*_WITH_3DES_.*</sec:include>
            <sec:include>.*_WITH_DES_.*</sec:include>
            <sec:exclude>.*_WITH_NULL_.*</sec:exclude>
            <sec:exclude>.*_DH_anon_.*</sec:exclude>
        </sec:cipherSuitesFilter>
    </http:tlsClientParameters>
</http:conduit>

<!-- -->
<!-- Select the Credentials to Authenticate -->
<!-- -->
...
<!-- -->
<!-- Configure Security for the Server's Own Endpoints -->
<!-- -->
...
</beans>

```

To complete the Artix server configuration, you also need to specify which credentials are to be authenticated, as described in [“Selecting Credentials to Authenticate” on page 369](#).



# Selecting Credentials to Authenticate

## Overview

Figure 38 shows an overview of the set-up required to configure authentication and authorization in an Artix server. To enable authentication, configure the server's security layer to select a particular credential type. In addition, if you want the server to perform authorization checks, you should associate an access control list file, `acl.xml`, with the security layer, as shown in Figure 38.

**Figure 38:** *Configuring Authentication and Authorization in an Artix Server*

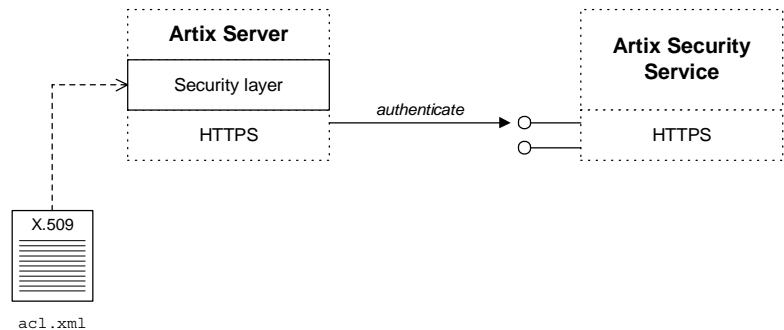

## ACL file

Because authentication and authorization usually go hand in hand, you would normally specify an *access control list* (ACL) file at the same time that you configure authentication. Example 64 shows an example of a simple ACL file that is used in the authorization demonstration located in `ArtixInstallDir/java/samples/security/authorization`.

**Example 64:** *Sample ACL File*

```
<secure-system
  xmlns="http://schemas.iona.com/security/acl"
  xmlns:xsi="http://www.w3.org/2001/XMLSchema-instance"
  xsi:schemaLocation="..." >
  <action-role-mapping>
    <server-name>artix.java.security.sample</server-name>
    <interface>
```

**Example 64:** *Sample ACL File*

```

<name>{http://apache.org/hello_world_soap_http}Greeter</name>
  <action-role>
    <action-name>sayHi</action-name>
    <role-name>guest</role-name>
  </action-role>
  <action-role>
    <action-name>greetMe</action-name>
    <role-name>president</role-name>
  </action-role>
</interface>
</action-role-mapping>
</secure-system>

```

The access control rules in [Example 64](#) associate WSDL operations (specified as `action-name` elements) with specific role names. Only users that have the specified roles will be allowed to invoke the relevant operations. For more details about ACL files, see [“Managing Access Control Lists” on page 351](#).

**ACL server name**

It is important to note here that you can, in principle, define multiple sets of rules in an ACL file, where each set of rules is enclosed in an `action-role-mapping` element. In order to select a specific rule set, use the identifier that appears in the `server-name` element.

**Enabling authentication and authorization**

There are a variety of different elements you can insert into an Artix server’s XML configuration in order to enable authentication and authorization. In general, you must use a different element type, depending on what type of credential you want to authenticate.

[Example 65](#) shows the general outline of an authentication element—represented by the placeholder, `CredentialAuthElement`—in a server’s XML configuration file. The attributes shown in [Example 65](#) are defined in the authentication elements’ base type and are thus common to all authentication elements.

**Example 65:** *Credential Authentication Element in a Server*

```

<beans xmlns="http://www.springframework.org/schema/beans"
  xmlns:jaxws="http://cxf.apache.org/jaxws"
  xmlns:security="http://schemas.ionac.com/soa/security-config"

```

**Example 65:** *Credential Authentication Element in a Server*

```

... >
...
1  <jaxws:endpoint name="{Namespace}TargetPort"
    createdFromAPI="true" >
    <jaxws:features>
2      <security:CredentialAuthElement
3          aclURL="ACLFile"
4          aclServerName="ServerName"
5          authorizationRealm="RealmName"
6          enableAuthorization="Boolean"
        />
    </jaxws:features>
</jaxws:endpoint>
...
</beans>

```

The preceding XML configuration can be described as follows:

1. The authentication feature is attached to the endpoint (WSDL port) specified by the `name` attribute of the `jaxws:endpoint` element, where the endpoint name is specified in QName format.

**Note:** You must specify the authentication feature *separately* for each endpoint that you want to protect with authentication and authorization.

2. For the possible credential elements, `security:CredentialAuthElement`, see the list of available credential types, “[Credential types available for authentication](#)” on page 373.
3. The `aclURL` attribute specifies the location of an ACL file—for example, `file:etc/acl.xml`.
4. The `aclServerName` attribute selects a particular rule set from the ACL file by specifying its server name—see “[ACL server name](#)” on page 370.
5. The `authorizationRealm` attribute specifies the authorization realm to which this server belongs—see “[Managing Users, Roles and Domains](#)” on page 335 for details.

6. By default, authorization is enabled whenever authentication is. If you would like to enable authentication *without* authorization, however, you can set the `enableAuthorization` attribute to `false`. In this case, there is no need to set the `aclURL`, `aclServerName`, or `authorizationRealm` attributes.

---

### credentialEndorser attribute

The authentication elements described here also support the `credentialEndorser` attribute (this attribute is not defined in the base type, however). The purpose of the credential endorser setting is to enable you to impose extra conditions on the credentials, before accepting them for authentication. In particular, a credential endorser enables you to check that credentials have been endorsed (that is, vouched for) by another set of trusted credentials—see [“Endorsements” on page 575](#) for more details.

To use the endorsement feature, the `credentialEndorser` attribute must be set equal to the name of the Java class that implements a *credential endorser*. Normally, it is not necessary to set this attribute, because the security schema automatically assigns a default credential endorser for each credential type. If you want to override the default, however, you can select one of the following standard endorser classes:

- `com.ionacxf.security.rt.NoOpCredentialEndorser`  
Establishes no endorsements between previously established credentials and the credential that is in the process of being created. Use this endorser if you wish to place no constraints on received credential information.
- `com.ionacxf.security.rt.RequireTLSCredentialEndorser`  
Checks for the availability of TLS credentials (which signifies that the incoming request has travelled across a secure TLS connection). If such TLS credentials exist, they are placed on the the list of credential endorsements for the credential that is in the process of being created. If there are no such TLS credentials available, the request is rejected with a `Fault` exception.
- `com.ionacxf.security.rt.RequireTLSClientAuthCredentialEndorser`  
Checks for the availability of TLS credentials containing a client certificate, indicating that the client application has authenticated itself over TLS to the server. If such TLS credentials exist, they are placed on the the list of credential endorsements for the credential in the

process of creation. If there are no such TLS credentials available, the request is rejected with a `Fault` exception.

---

**Custom endorsers**

You can optionally implement your own custom endorsers. For details, see [“Endorsements” on page 575](#).

---

**Credential types available for authentication**

The following credentials types can be presented for authentication:

- [TLS X.509 certificate](#).
- [HTTP Basic Authentication](#).
- [WSS username token](#).
- [WSS binary security token](#).
- [WSS X.509 certificate](#).

---

**TLS X.509 certificate**

To enable authentication of X.509 certificates received through the TLS protocol, use the `security:TLSAuthServerConfig` element as the authentication element. A typical example of a `TLSAuthServerConfig` element is shown in [Example 66](#).

**Example 66:** *TLSAuthServerConfig Element*

```
<security:TLSAuthServerConfig
  aclURL="ACLFile"
  aclServerName="ServerName"
  authorizationRealm="RealmName"
/>
```

The `TLSAuthServerConfig` element inherits all of the attributes shown in [Example 65 on page 370](#) and also supports the `credentialEndorser` attribute (default setting is `NoOpCredentialEndorser`).

## HTTP Basic Authentication

To enable authentication of username and password credentials received through the HTTP Basic Authentication protocol, use the `security:HTTPBasicServerConfig` element as the authentication element. A typical example of a `HTTPBasicServerConfig` element is shown in [Example 67](#).

### Example 67: `HTTPBasicServerConfig` Element

```
<security:HTTPBasicServerConfig
  aclURL="ACLFile"
  aclServerName="ServerName"
  authorizationRealm="RealmName"
/>
```

The `HTTPBasicServerConfig` element inherits all of the attributes shown in [Example 65 on page 370](#) and also supports the `credentialEndorser` attribute (default setting is `RequireTLSCredentialEndorser`).

## WSS username token

To enable authentication of username and password credentials received through the SOAP protocol (in a WSS UsernameToken header), use the `security:WSSUsernameTokenAuthServerConfig` element as the authentication element. A typical example of a `WSSUsernameTokenAuthServerConfig` element is shown in [Example 68](#).

### Example 68: `WSSUsernameTokenAuthServerConfig` Element

```
<security:WSSUsernameTokenAuthServerConfig
  aclURL="ACLFile"
  aclServerName="ServerName"
  authorizationRealm="RealmName"
/>
```

The `WSSUsernameTokenAuthServerConfig` element inherits all of the attributes shown in [Example 65 on page 370](#) and also supports the `credentialEndorser` attribute (default setting is `RequireTLSCredentialEndorser`).

## WSS binary security token

To enable authentication of binary token credentials received through the SOAP protocol (in a WSS BinarySecurityToken header), use the `security:WSSBinarySecurityTokenAuthServerConfig` element as the authentication element. The following kinds of credential are transmitted as binary security tokens in Artix:

- IONA SSO token.
- Kerberos token.

A typical example of a `WSSBinarySecurityTokenAuthServerConfig` element is shown in [Example 69](#).

### Example 69: *WSSBinarySecurityTokenAuthServerConfig* Element

```
<security:WSSBinarySecurityTokenAuthServerConfig
  aclURL="ACLFile"
  aclServerName="ServerName"
  authorizationRealm="RealmName"
/>
```

The `WSSBinarySecurityTokenAuthServerConfig` element inherits all of the attributes shown in [Example 65 on page 370](#) and also supports the `credentialEndorser` attribute (default setting is `RequireTLSClientAuthCredentialEndorser`).

**WSS X.509 certificate**

To enable authentication of X.509 certificates received through the SOAP protocol (in a WSS X.509 certificate header), use the `security:WSSX509CertificateAuthServerConfig` element as the authentication element. A typical example of a `WSSX509CertificateAuthServerConfig` element is shown in [Example 70](#).

**Example 70:** *WSSX509CertificateAuthServerConfig Element*

```
<security:WSSX509CertificateAuthServerConfig
  aclURL="ACLFile"
  aclServerName="ServerName"
  authorizationRealm="RealmName"
/>
```

The `WSSX509CertificateAuthServerConfig` element inherits all of the attributes shown in [Example 65 on page 370](#) and also supports the `credentialEndorser` attribute (default setting is `NoOpCredentialEndorser`).

**Note:** Currently, it is only possible to send an X.509 certificate in a WSS SOAP header, if the certificate is used to sign or encrypt portions of the SOAP message (configurable using the *WSS partial message protection* feature).

**Example configuration**

The sample XML configuration in [Example 71](#) shows how to enable WSS username and password authentication and authorization for the endpoint with QName, `{http://apache.org/hello_world_soap_http}SoapPort`. The authentication feature is associated with the ACL file, `etc/acl.xml`.

**Example 71:** *Enabling WSS UsernameToken Authentication*

```
<beans xmlns="http://www.springframework.org/schema/beans"
  xmlns:jaxws="http://cxf.apache.org/jaxws"
  xmlns:security="http://schemas.iona.com/soa/security-config"
  ... >
  ...
  <jaxws:endpoint name="{http://apache.org/hello_world_soap_http}SoapPort"
    createdFromAPI="true">
    <jaxws:features>
      <security:WSSUsernameTokenAuthServerConfig
        aclURL="file:etc/acl.xml"
        aclServerName="artix.java.security.sample"
```



**Example 71:** *Enabling WSS UsernameToken Authentication*

```
        authorizationRealm="corporate"  
    />  
    </jaxws:features>  
    </jaxws:endpoint>  
    ...  
</beans>
```



# Configuring the Artix Security Plug-In—C++ Runtime

*Artix allows you to configure a number of security features directly from the Artix contract describing your system.*

## In this chapter

This chapter discusses the following topics:

<a href="#">The Artix Security Plug-In</a>	<a href="#">page 380</a>
<a href="#">Configuring an Artix Configuration File</a>	<a href="#">page 381</a>
<a href="#">Configuring a WSDL Contract</a>	<a href="#">page 383</a>

---

# The Artix Security Plug-In

---

## Overview

This section describes how to initialize the Artix security plug-in, which is responsible for performing authentication and authorization for non-CORBA bindings (CORBA bindings use the `gsp` plug-in) and is also responsible for inserting and extracting credentials to and from SOAP 1.2 message headers.

The Artix security plug-in implements only a part of Artix security. Specifically, it is *not* responsible for transmitting credentials, nor does it implement any cryptographic algorithms.

---

## Load the `artix_security` plug-in

To load the Artix security plug-in, you must include `artix_security` in the `orb_plugins` list in your application's configuration scope.

Edit your application's configuration scope in the Artix configuration file so that it includes the following configuration settings:

```
# Artix Configuration File
orb_plugins = ["xmlfile_log_stream", "iiop_profile", "giop",
              "iiop_tls", "soap", "at_http", "artix_security", "https"];

plugins:artix_security:shlib_name = "it_security_plugin";
binding:artix:server_request_interceptor_list =
    "principal_context+security";
binding:artix:client_request_interceptor_list =
    "security+principal_context";
```

The `orb_plugins` list for your application might differ from the one shown here, but it should include the `artix_security` entry.

---

## Enable the `artix_security` plug-in

The `artix_security` plug-in is enabled by default, once it is loaded into your application. You might like to check, however, that the plug-in is not accidentally disabled, as follows:

- If the `policies:asp:enable_security` variable is present in your application's configuration (or an enclosing configuration scope), it should be set to `true`.
- If the `enableSecurity` attribute appears in `<bus-security:security>` in your WSDL contract, it should be set to `true`.

# Configuring an Artix Configuration File

## Overview

You can tailor the behavior of the Artix security plug-in by setting configuration variables in the Artix configuration file, `artix.cfg`, as described here. The settings in the configuration file are applied, by default, to all the services and ports in your WSDL contract.

## Prerequisites

Before configuring the Artix security plug-in, you must ensure that the plug-in is loaded into your application. See [“Load the artix\\_security plug-in” on page 380](#).

## Artix security plug-in configuration variables

The complete set of Artix security plug-in variables, which are all optional, are listed and described in [Table 10](#). These settings are applied by default to all services and ports in the WSDL contract.

**Table 10:** *The Artix Security Plug-In Configuration Variables*

Configuration Variable	Description
<code>policies:asp:enable_security</code>	A boolean variable that enables the <code>artix_security</code> plug-in. When <code>true</code> , the plug-in is enabled; when <code>false</code> , the plug-in is disabled. Default is <code>true</code> . <b>Note:</b> You can override this setting in the WSDL contract. See <a href="#">“Configuring a WSDL Contract” on page 383</a> .
<code>plugins:is2_authorization:action_role_mapping</code>	A variable that specifies the action-role mapping file URL.
<code>policies:asp:enable_authorization</code>	A boolean variable that specifies whether Artix should enable authorization using the Artix Security Framework. Default is <code>false</code> .
<code>plugins:asp:authentication_cache_size</code>	The maximum number of credentials stored in the authentication cache. If exceeded, the oldest credential in the cache is removed. A value of -1 (the default) means unlimited size. A value of 0 means disable the cache.

**Table 10:** *The Artix Security Plug-In Configuration Variables*

Configuration Variable	Description
<code>plugins:asp:authentication_cache_timeout</code>	<p>The time (in seconds) after which a credential is considered stale. Stale credentials are removed from the cache and the server must re-authenticate with the Artix security service on the next call from that user.</p> <p>A value of -1 means an infinite time-out. A value of 0 means disable the cache. The value must lie within the range -1 to <math>2^{31}-1</math>.</p> <p>Default is 600 seconds.</p>
<code>plugins:asp:security_level</code>	<p>This variable specifies the level from which security credentials are picked up. For a detailed description of the allowed values, see <a href="#">plugins:asp:security_level</a>.</p>
<code>plugins:asp:authorization_realm</code>	<p>This variable specifies the Artix authorization realm to which an Artix server belongs. The value of this variable determines which of a user's roles are considered when making an access control decision.</p>
<code>plugins:asp:default_password</code>	<p>This variable specifies the password to use on the server side when the <code>securityType</code> attribute is set to either <code>PRINCIPAL</code> or <code>CERT_SUBJECT</code>.</p>
<code>plugins:asp:enable_security_service_load_balancing</code>	<p>This boolean variable enables load balancing over a cluster of Artix security services. For details of how to enable security service clustering, see <a href="#">“Clustering and Federation” on page 313</a>.</p>
<code>plugins:asp:enable_security_service_cert_authentication</code>	<p>This boolean variable enables authentication based on the client certificate extracted from the TLS security layer. For details of how to enable this kind of authentication, see <a href="#">“X.509 Certificate-Based Authentication—C++ Runtime” on page 123</a>.</p>

# Configuring a WSDL Contract

## Overview

Occasionally you will need finer grained control of your system's security than is provided through the standard Artix and security configuration. Artix provides the ability to control security on a per-port basis by describing the service's security settings in the Artix contract that describes it. This is done by using the `<bus-security:security>` extension in the `port` element describing the service's address and transport details.

## Namespace

The XML namespace defining `<bus-security:security>` is `http://schemas.iona.com/bus`. You need to add the following line to the `definitions` element of any contracts that use the `bus-security:security` element:

```
xmlns:bus-security="http://schemas.iona.com/bus/security"
```

## `<bus-security:security>` attributes

The complete set of `<bus-security:security>` attributes, which are all optional, are listed [Table 11](#). Each attribute maps to an equivalent configuration variable, as shown in the table. The attributes specified in the WSDL contract override settings specified in the Artix configuration file.

**Table 11:** `<bus-security:security>` Attributes

<code>&lt;bus-security:security&gt;</code> Attribute	Equivalent Configuration Variable
<code>enableSecurity</code>	<code>policies:asp:enable_security</code>
<code>is2AuthorizationActionRoleMapping</code>	<code>plugins:is2_authorization:action_role_mapping</code>
<code>enableAuthorization</code>	<code>policies:asp:enable_authorization</code>
<code>authenticationCacheSize</code>	<code>plugins:asp:authentication_cache_size</code>
<code>authenticationCacheTimeout</code>	<code>plugins:asp:authentication_cache_timeout</code>
<code>securityType</code>	<code>plugins:asp:security_type</code> ( <i>Obsolete</i> )
<code>securityLevel</code>	<code>plugins:asp:security_level</code>
<code>authorizationRealm</code>	<code>plugins:asp:authorization_realm</code>

**Table 11:** `<bus-security:security>` Attributes

<code>&lt;bus-security:security&gt;</code> Attribute	Equivalent Configuration Variable
defaultPassword	<code>plugins:asp:default_password</code>

**Enabling security for a service**

[Example 72](#) shows how to enable security for the service `personalInfoService`.

**Example 72:** *Enabling Security in an Artix Contract*

```
<definitions ...
  xmlns:bus-security="http://schemas.iona.com/bus/security"
  ...>
...
<service name="personalInfoService">
  <port name="personalInfoServicePort" binding="tns:infoSOAPBinding">
    <soap:address location="http://localhost:8080"/>
    <bus-security:security enableSecurity="true"
      is2AuthorizationActionRoleMapping="file://c:/iona/artix/2.0/bin/action_role.xml"
      enableAuthorization="true"
      securityLevel="REQUEST_LEVEL"
      authenticationCacheSize="5"
      authenticationCacheTimeout="10" />
  </port>
</service>
</definitions>
```

The `bus-security:security` element in [Example 72](#) configures `personalInfoService` to use WS Security compliant username/password authentication.



**Disabling security for a service**

[Example 73](#) shows how to selectively disable security for the service `widgetService`.

**Example 73:** *Disabling Security in an Artix Contract*

```
<definitions ....
  xmlns:bus-security="http://schemas.iona.com/bus/security"
  ...>
...
<service name="widgetService">
  <port name="widgetServicePort" binding="tns:widgetSOAPBinding">
    <soap:address location="http://localhost:8080"/>
    <bus-security:security enableSecurity="false" />
  </port>
</service>
</definitions>
```



# Part IV

## Artix Security Features

---

### In this part

This part contains the following chapters:

<a href="#">Single Sign-On</a>	<a href="#">page 389</a>
<a href="#">Publishing WSDL Securely—C++ Runtime</a>	<a href="#">page 419</a>
<a href="#">Partial Message Protection—C++ Runtime</a>	<a href="#">page 433</a>
<a href="#">Principal Propagation—C++ Runtime</a>	<a href="#">page 485</a>
<a href="#">Bridging between SOAP and CORBA—C++ Runtime</a>	<a href="#">page 499</a>



# Single Sign-On

*Single sign-on (SSO) is an Artix security framework feature which is used to minimize the exposure of usernames and passwords to snooping. After initially signing on, a client communicates with other applications by passing an SSO token in place of the original username and password.*

**Note:** The SSO feature is unavailable in some editions of Artix. Please check the conditions of your Artix license to see whether your installation supports SSO.

## In this chapter

This chapter discusses the following topics:

<a href="#">SSO and the Login Service</a>	<a href="#">page 390</a>
<a href="#">Username/Password-Based SSO for SOAP Bindings—Java Runtime</a>	<a href="#">page 393</a>
<a href="#">Username/Password-Based SSO for SOAP Bindings—C++ Runtime</a>	<a href="#">page 407</a>

---

# SSO and the Login Service

---

## Overview

There are two different implementations of the login service, depending on the type of bindings you use in your application:

- [SOAP binding](#).
- 

## SOAP binding

For SOAP bindings, SSO is implemented by the following elements of the Artix security framework:

- *Artix login service*—a central service that authenticates username/password combinations and returns SSO tokens. Clients connect to this service using the HTTP/S protocol.
  - *login\_client plug-in*—the `login_client` plug-in, which is loaded by SOAP clients, is responsible for contacting the Artix login service to obtain an SSO token.
  - *artix\_security plug-in*—on the server side, the `artix_security` plug-in is responsible for parsing the received SSO credentials and authenticating the SSO token with the Artix security service.
- 

## Advantages of SSO

SSO greatly increases the security of an Artix security framework system, offering the following advantages:

- Password visibility is restricted to the login service.
- Clients use SSO tokens to communicate with servers.
- Clients can be configured to use SSO with no code changes.
- SSO tokens are configured to expire after a specified length of time.
- When an SSO token expires, the Artix client automatically requests a new token from the login service. No additional user code is required.

**Login service**

Figure 39 shows an overview of a login service. The client Bus automatically requests an SSO token by sending a username and a password to the login service. If the username and password are successfully authenticated, the login service returns an SSO token.

**Figure 39:** Client Requesting an SSO Token from the Login Service

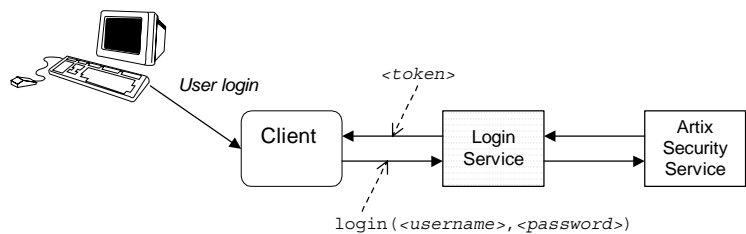
**SSO token**

The SSO token is a compact key that the Artix security service uses to access a user's session details, which are stored in a cache.

**SSO token expiry**

The Artix security service is configured to impose the following kinds of timeout on an SSO token:

- *SSO session timeout*—this timeout places an absolute limit on the lifetime of an SSO token. When the timeout is exceeded, the token expires.
- *SSO session idle timeout*—this timeout places a limit on the amount of time that elapses between authentication requests involving the SSO token. If the central Artix security service receives no authentication requests in this time, the token expires.

For more details, see [“Configuring Single Sign-On Properties” on page 331](#).

**Automatic token refresh**

In theory, the expiry of SSO tokens could prove a nuisance to client applications, because servers will raise a security exception whenever an SSO token expires. In practice, however, when SSO is enabled, the relevant plug-in (`login_service` for SOAP and `gsp` for CORBA) catches the exception

on the client side and contacts the login service again to refresh the SSO token automatically. The plug-in then automatically retries the failed operation invocation.



---

# Username/Password-Based SSO for SOAP Bindings—Java Runtime

---

## Overview

When using SOAP bindings in the Java runtime, usernames and passwords can be transmitted using one of the following mechanisms:

- WSS UsernameToken.
- HTTP Basic Authentication.

This section describes how to configure a client so that it transmits an SSO token in place of a username and a password.

---

## Username/password authentication without SSO

Figure 40 gives an overview of ordinary username/password-based authentication without SSO. In this case, the username, `<username>`, and password, `<password>`, are passed directly to the target server, which then contacts the Artix security service to authenticate the username/password combination.

**Figure 40:** Overview of Username/Password Authentication without SSO

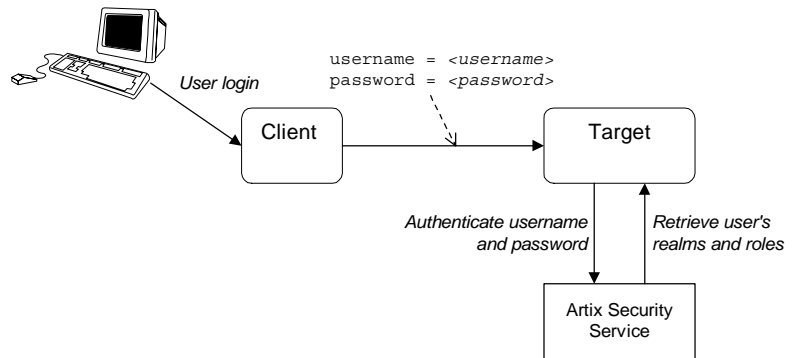

## Username/password authentication with SSO

Figure 41 gives an overview of username/password-based authentication when SSO is enabled.

**Figure 41:** Overview of Username/Password Authentication with SSO

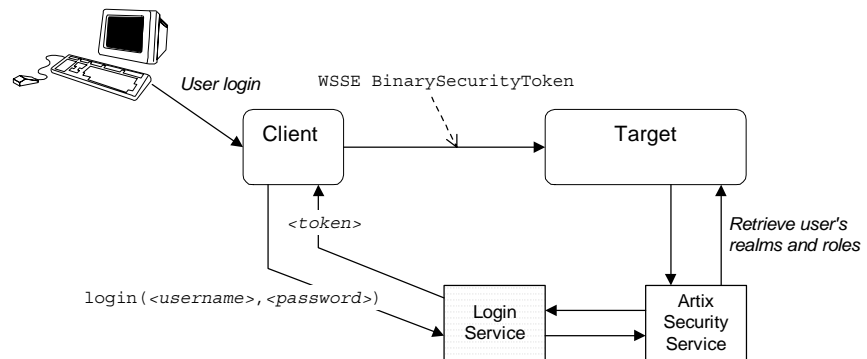

Prior to contacting the target server for the first time, the client Bus sends the username, `<username>`, and password, `<password>`, to the login server, getting an SSO token, `<token>`, in return. The client Bus then includes a WSS BinarySecurityToken in a SOAP header (with a proprietary `valueType`, `http://schemas.ionas.com/security/IONASSToken`) in the next request to the target server. The target server's Bus contacts the Artix security service to validate the SSO token passed in the WSS Binary SecurityToken.

## Client configuration

Example 74 shows the XML configuration for an SSO SOAP client that employs username/password authentication.

**Example 74:** Client Configuration for Username/Password-based SSO

```

<beans
  xmlns="http://www.springframework.org/schema/beans"
  xmlns:http="http://cxf.apache.org/transports/http/configuration"
  xmlns:jaxws="http://cxf.apache.org/jaxws"
  xmlns:sec="http://cxf.apache.org/configuration/security"
  xmlns:security="http://schemas.ionas.com/soa/security-config"
  xmlns:xsi="http://www.w3.org/2001/XMLSchema-instance"
  xsi:schemaLocation="...">
  
```

**Example 74:** *Client Configuration for Username/Password-based SSO*

```

1  <jaxws:client
    name="{http://apache.org/hello_world_soap_http}SoapPort"
    createdFromAPI="true">
2  <jaxws:features>
    <security:LoginClientConfig
        loginServiceWsdlURL="file:etc/login_service.wsdl"
    />
    </jaxws:features>
</jaxws:client>
...
3  <http:conduit
name="{http://ws.iona.com/login_service}LoginServicePort.http
-conduit">
4  <http:tlsClientParameters>
    <sec:keyManagers keyPassword="password">
        <sec:keyStore type="jks"
            resource="keys/isf-client.jks"
            password="password"/>
    </sec:keyManagers>
    <sec:trustManagers>
        <sec:keyStore type="jks"
            password="password"
            file="keys/isf-client.jks"/>
    </sec:trustManagers>
    </http:tlsClientParameters>
</http:conduit>
</beans>

```

The preceding Artix configuration can be described as follows:

1. Enable the single sign-on feature for the endpoint that the client wants to connect to, `{http://apache.org/hello_world_soap_http}SoapPort`. In general, you need to enable the single sign-on feature for *each* of the remote endpoints individually.
2. Include the `security:LoginClientConfig` element to enable the single sign-on feature for the current endpoint. The `loginServiceWsdlURL` attribute specifies the location of the login service's WSDL contract, which provides the address of the login service port—see [“Login service WSDL configuration” on page 406](#).

3. It is also necessary to supply TLS settings for the login service port, `{http://ws.iona.com/login_service}LoginServicePort`, so that the client can establish a secure HTTPS connection to the login service.
4. The `http:tlsClientParameters` element provides the typical configuration settings that you need for a HTTPS connection. For more details about these settings, see [“Configuring HTTPS and IIOP/TLS Authentication” on page 195](#). Though not shown here, it is also *strongly* advisable to restrict the available set of cipher suites with a cipher suite filter—see [“Configuring HTTPS Cipher Suites—Java Runtime” on page 233](#).

**WARNING:** It is essential to customize an application’s own X.509 certificates and trusted CA certificates in order to configure a truly secure TLS system. It is also essential to customize the set of available cipher suites (some default cipher suites provide very weak security).

## Target configuration

[Example 75](#) shows the XML configuration for an SSO SOAP target server that accepts connections from clients that authenticate themselves using username/password authentication.

### Example 75: Target Configuration for Username/Password-based SSO

```
<beans xmlns="http://www.springframework.org/schema/beans"
  xmlns:xsi="http://www.w3.org/2001/XMLSchema-instance"
  xmlns:http="http://cxf.apache.org/transports/http/configuration"
  xmlns:httpj="http://cxf.apache.org/transports/http-jetty/configuration"
  xmlns:jaxws="http://cxf.apache.org/jaxws"
  xmlns:sec="http://cxf.apache.org/configuration/security"
  xmlns:security="http://schemas.iona.com/soa/security-config"
  xsi:schemaLocation="...">
1  <jaxws:endpoint
    name="{http://apache.org/hello_world_soap_http}SoapPort"
    createdFromAPI="true">
2    <jaxws:features>
      <security:WSSBinarySecurityTokenAuthServerConfig
        aclURL="file:etc/acl.xml"
        aclServerName="artix.java.security.sample"
        authorizationRealm="corporate"
      />
    />
```

**Example 75:** Target Configuration for Username/Password-based SSO

```

    </jaxws:features>
  </jaxws:endpoint>
3  <security:IsfClientConfig
    id="it.soa.security"
    IsfServiceWsdLoc="file:etc/isf_service.wsdl"
  />
4  <http:conduit
    name="{http://schemas.iona.com/idl/isf_service.idl}IT_ISF.ServiceManagerSOAPPort.http-conduit">
5    <http:tlsClientParameters>
      <sec:keyManagers keyPassword="password">
        <sec:keyStore type="jks"
          password="password"
          resource="keys/isf-client.jks"/>
      </sec:keyManagers>
      <sec:trustManagers>
        <sec:keyStore type="jks"
          password="password"
          file="keys/isf-client.jks"/>
      </sec:trustManagers>
    </http:tlsClientParameters>
  </http:conduit>
6  <http:conduit
    name="{http://schemas.iona.com/idl/isfx_authn_service.idl}IT_ISFX.AuthenticationServiceSOAPPort.http-conduit">
    <http:tlsClientParameters>
      <sec:keyManagers keyPassword="password">
        <sec:keyStore type="jks"
          password="password"
          resource="keys/isf-client.jks"/>
      </sec:keyManagers>
      <sec:trustManagers>
        <sec:keyStore type="jks"
          password="password"
          file="keys/isf-client.jks"/>
      </sec:trustManagers>
    </http:tlsClientParameters>
  </http:conduit>
  ...
</beans>

```

The preceding Artix configuration can be described as follows:

1. Enable WSS binary security token authentication for the endpoint, `{http://apache.org/hello_world_soap_http}SoapPort`. In general, you need to enable authentication for *each* of the server endpoints individually.
2. The `security:WSSBinarySecurityTokenAuthServerConfig` element configures the server to perform authentication and authorization based on the received WSS binary security token. The following attributes must be set:
  - ◆ `aclURL`—specifies the location of the access control list (ACL) file.
  - ◆ `aclServerName`—specifies which of the `action-role-mapping` elements in the action role mapping file should apply to the incoming requests (must match the `server-name` element in one of the `action-role-mapping` elements).
  - ◆ `authorizationRealm`—specifies the name of the authorization realm for this endpoint. See [“Introduction to Domains and Realms” on page 336](#).
3. The `security:IsfClientConfig` element is used to configure the handler that opens a connection to the Artix security service. The `IsfServiceWsdLoc` attribute specifies the location of the WSDL contract for the Artix security service.
4. The following client settings are applied to the *service manager* port on the Artix security service, which has the QName, `{http://schemas.iona.com/idl/isf_service.idl}IT_ISF.ServiceManagerSOAPPort`. The service manager service is responsible for bootstrapping connections to the other WSDL services hosted by the Artix security service.
5. The `http:tlsClientParameters` element provides the typical configuration settings that you need for a HTTPS connection. For more details about these settings, see [“Configuring HTTPS and IIOP/TLS Authentication” on page 195](#).

6. You also need to configure a secure HTTPS connection to the SOAP authentication port on the Artix security service, which has the QName,
- ```
{http://schemas.iona.com/idl/isfx_authn_service.idl}IT_ISFX.AuthenticationServiceSOAPPort.
```

**WARNING:** It is essential to customize an application's own X.509 certificates and trusted CA certificates in order to configure a truly secure TLS system. It is also essential to customize the set of available cipher suites (some default cipher suites provide very weak security).

### Artix login service configuration

[Example 76](#) shows the domain configuration for an Artix login service that is integrated with the Artix security service (that is, both services run in the same process).

#### Example 76: Artix Login Service Configuration

```
include "../../../../../cxx_java/etc/domains/artix.cfg";

security_service
{
    #
    # HOST and PORT settings
    #
    1 ISF_HOSTNAME = "localhost";
    ISF_IIOPTLS_PORT = "55020";
    #
    # ORB plugins for CORBA services
    #
    orb_plugins = ["local_log_stream", "iiop_profile", "giop",
"iiop_tls"];
    #
    # Event logging
    #
    event_log:filters = ["IT_SECURITY=WARN+ERROR+FATAL",
"IT_JAVA_SERVER=*"];
    plugins:local_log_stream:filename = "isf.log";
    #
    # Configuration of the Java plugin to the
    # IONA Generic Server container
    #
    2 generic_server_plugin = "java_server";
    plugins:java_server:shlib_name = "it_java_server";
```

**Example 76:** *Artix Login Service Configuration*

```

3     plugins:java_server:class =
      "com.ionajbus.security.services.SecurityServer";
      plugins:java_server:classpath =
        "../../../../../cxx_java/lib/artix/security_service/5.0/security_service-rt.jar";
4     plugins:java_server:system_properties =
      ["org.omg.CORBA.ORBClass=com.ionajbus.corba.art.artimpl.ORBImpl",
      "org.omg.CORBA.ORBSingletonClass=com.ionajbus.corba.art.artimpl.ORBSingleton", "is2.properties=is2.properties",
      "java.endorsed.dirs=../../../../cxx_java/lib/endorsed"];
      plugins:java_server:jni_verbose = "false";
      plugins:java_server:X_options = ["rs"];
      #
      # Host and port settings for CORBA services
      #
5     initial_references:IT_SecurityService:reference =
      "corbaloc:iiops:1.2@localhost:%{ISF_IIOP_TLS_PORT},it_iiops:1.2@localhost:%{ISF_IIOP_TLS_PORT}/IT_SecurityService";
      policies:iiop:server_address_mode_policy:local_hostname =
        "%{ISF_HOSTNAME}";
6     plugins:security:iiop_tls:addr_list =
      ["%{ISF_HOSTNAME}:%{ISF_IIOP_TLS_PORT}"];
      plugins:security:direct_persistence = "true";
      #
      # TLS settings for CORBA services
      #
7     principal_sponsor:use_principal_sponsor = "true";
      principal_sponsor:auth_method_id = "pkcs12_file";
      principal_sponsor:auth_method_data =
      ["filename=./keys/isf-server.p12",
      "password=administratorpass"];
      policies:trusted_ca_list_policy = "../keys/isf-trustdb.pem";

8     policies:client_secure_invocation_policy:requires =
      ["Confidentiality"];
      policies:client_secure_invocation_policy:supports =
      ["Confidentiality", "EstablishTrustInTarget",
      "EstablishTrustInClient", "DetectMisordering",
      "DetectReplay", "Integrity"];
      policies:target_secure_invocation_policy:requires =
      ["Confidentiality"];
      policies:target_secure_invocation_policy:supports =
      ["Confidentiality", "EstablishTrustInTarget",
      "EstablishTrustInClient", "DetectMisordering",
      "DetectReplay", "Integrity"];

```



**Example 76:** *Artix Login Service Configuration*

```

#
# Additional certificate constraints on inbound CORBA
# requests
#
9 policies:security_server:client_certificate_constraints=["CN=*"]
;
10 policies:external_token_issuer:client_certificate_constraints=[]
;
#
# Artix Bus configuration
#
11 bus
{
#
# Bus plugins for Artix services
#
12 orb_plugins = ["local_log_stream", "java",
"wsdl_publish", "iiop_profile", "giop", "iiop_tls",
"artix_security", "login_service"];
13 java_plugins= ["isf"];
14 bus:initial_contract:url:isf_service =
"isf_service.wsdl";
#
# Login Service configuration
#
15 binding:artix:server_request_interceptor_list=
"security";
16 bus:initial_contract:url:login_service =
"login_service.wsdl";
17 policies:asp:enable_authorization="false";
18 policies:asp:enable_security="false";
#
# TLS settings for Artix services
#
19 plugins:at_http:server:use_secure_sockets="true";
plugins:at_http:server:server_certificate =
"../keys/isf-server.p12";
plugins:at_http:server:server_private_key_password =
"administratorpass";
plugins:at_http:server:trusted_root_certificates =
"../keys/isf-trustdb.pem";
policies:target_secure_invocation_policy:requires =
["Confidentiality", "Integrity", "DetectMisordering",
"DetectReplay", "EstablishTrustInClient"];
#

```

**Example 76:** *Artix Login Service Configuration*

20

```

# Additional certificate constraints on inbound
# Artix requests
#
policies:certificate_constraints_policy = ["CN=*"];
};
};

```

The preceding Artix configuration can be described as follows:

1. For convenience, the `ISF_HOSTNAME` and `ISF_IIOPTLS_PORT` substitution variables enable you to alter the IP address of the Artix security service by editing just these two lines.
2. The core of the Artix security service is implemented as a pure Java program. To make the security service accessible through the IIOP/TLS protocol, the Java code is hosted inside an Artix generic server.
3. The `plugins:java_server:class` setting specifies the entry point for the Java implementation of the security service. The implementation defined by `com.iona.jbus.security.services.SecurityServer` effectively acts as a *double container*. That is, it hosts two different kinds of service:
  - ◆ *CORBA-based security service*—the generic server wraps the security service in a CORBA wrapper layer, effectively making the security service accessible through the IIOP/TLS protocol. The configuration settings for this service are taken from the current configuration scope.
  - ◆ *Any Artix-based service*—the generic server instantiates an Artix Bus, which can be used to host *any* Artix-based service. The configuration settings for the Artix-based services are taken from the `bus` sub-scope of the current configuration scope.
4. This line sets the system properties for the Java implementation of the security service. In particular, the `is2.properties` property specifies the location of a properties file, which contains further property settings for the Artix security service.

5. The `IT_SecurityService` initial reference setting provides the endpoint details for connecting to the security service through the IOP/TLS protocol. You should ensure that this setting is available in the scope of any CORBA application that needs to connect to the security service. If you want to change the address of the Artix security service, you can simply edit the `ISF_HOSTNAME` and `ISF_IOP_TLS_PORT` substitution variables (see [1](#)).
6. The `plugins:security:iop_tls:addr_list` setting is used to specify the IP address where the Artix security service listens for IOP/TLS requests. If you want to change the address of the Artix security service, you can simply edit the `ISF_HOSTNAME` and `ISF_IOP_TLS_PORT` substitution variables (see [1](#)).
7. The following `principal_sponsor` configuration settings are used to specify the Artix security service's own X.509 certificate. The `policies:trusted_ca_list_policy` setting is used to specify a list of trusted CA certificates. These settings are required in order to support the IOP/TLS protocol—see [“Configuring HTTPS and IOP/TLS Authentication” on page 195](#) for more details.
8. The secure invocation policies specified in the following lines require both incoming and outgoing IOP/TLS connections to be secure. For more details about SSL/TLS secure invocation policies, see [“Configuring Secure Associations” on page 241](#).
9. The security service requires that any clients attempting to open a connection must present an X.509 certificate to identify themselves. In addition, the security service supports a primitive form of access control: client certificates will be rejected unless they conform to the constraints specified in `policies:security_server:client_certificate_constraints`.

For details of how to specify certificate constraints, see [“Applying Constraints to Certificates” on page 605](#).

**Note:** The

`policies:security_server:client_certificate_constraints` setting must be present in the security service’s configuration scope, otherwise the security service will not start.

10. The security service supports a special kind of access, where a client can obtain security tokens without providing a password, based on a username alone. This type of access is needed to support interoperability with the mainframe platform. Normally, however, this feature should be disabled to avoid opening a security hole. To disable the token issuer, set the token issuer’s certificate constraints to be an empty list (as shown here). This causes the token issuer to reject all clients, effectively disabling this feature.

**Note:** The

`policies:external_token_issuer:client_certificate_constraints` setting must be present in the security service’s configuration scope, otherwise the security service will not start.

11. This line defines the start of the special `bus` sub-scope, which is used to configure Artix-based services that run inside the generic server’s Bus instance.
12. The `orb_plugins` list must include the `java` plug-in, the `wSDL_publish` plug-in, the `artix_security` plug-in, and the `login_service` plug-in.
13. The `java_plugins` list lets you load Artix Java plug-ins (see the *JAX-RPC Programmer’s Guide* for more details) and in this case a single plug-in, `isf`, is loaded. The `isf` plug-in is responsible for exposing the security service core as an Artix service. The `plugins:isf:classname` variable specifies the entry point for the implementation of the `isf` plug-in.
14. The `bus:initial_contract:url:isf_service` variable specifies the location of the Artix security service WSDL contract. You must edit this setting, if you store this contract at a different location.

15. The `security` interceptor must appear in the Artix server interceptor list to enable the `artix_security` plug-in functionality.
16. The `bus:initial_contract:url:login_service` variable specifies the location of the Artix login service WSDL contract. You must edit this setting, if you store this contract at a different location.
17. You must disable authorization in the login service. It is *not* appropriate for the login service to perform authorization checks on incoming requests (the login service does perform authentication, however).
18. This setting completely disables the security features of the `artix_security` plug-in, `artix_security`, in the `bus` configuration scope (in particular, disabling the authentication feature).

The Artix security service (SOAP/HTTPS accessible) and the Artix login services have conflicting requirements for this setting: the security service requires the `artix_security` plug-in to be disabled, whereas the login service requires it to be enabled. This conflict is resolved by re-enabling authentication in the login service's WSDL port (see [“Login service WSDL configuration” on page 406](#)).
19. The TLS settings in the `Bus` scope are the standard sort of settings you need for a service that uses the secure HTTPS protocol. These settings apply equally to the Artix security service (when accessed through the SOAP/HTTPS protocol) and to the Artix login service.

For more details about these settings, see [“Configuring HTTPS and IIOP/TLS Authentication” on page 195](#).
20. The HTTPS-based security service supports a primitive form of access control, whereby client certificates are rejected unless they conform to the constraints specified in `policies:certificate_constraints_policy`.

For details of how to specify certificate constraints, see [“Applying Constraints to Certificates” on page 605](#).

**Login service WSDL configuration** Example 77 shows an extract from the login service WSDL contract (in the directory, `java/samples/security/sso/etc`) showing details of the WSDL port settings.

**Example 77:** *Login Service WSDL Configuration*

```
<definitions ... >
...
  <service name="LoginService">
    <port binding="tns:LoginServiceBinding"
          name="LoginServicePort">
      <soap:address
        location="https://localhost:49675"/>
      <bus-security:security enableSecurity="true"/>
    </port>
  </service>
</definitions>
```

Note the following points about the WSDL port settings:

- The login service listens on a fixed host and port, `https://localhost:49675`. You will probably need to edit this setting before deploying the login service in a real system. However, you should *not* choose dynamic IP port allocation (for example, using `https://HostName:0`), because clients would not be able to discover the value of the dynamically allocated port.
- The `bus-security:security` element sets `enableSecurity` to `true`, which has the effect of enabling the authentication feature of the Artix security plug-in (for this WSDL port only). This attribute setting overrides the `policies:asp:enable_security` setting in the `security_server.bus` scope of the Artix configuration file, `security_service.cfg`.

# Username/Password-Based SSO for SOAP Bindings—C++ Runtime

## Overview

When using SOAP bindings in the C++ runtime, usernames and passwords can be transmitted using one of the following mechanisms:

- WSS UsernameToken.
- HTTP Basic Authentication.
- CORBA Principal (username only).

This section describes how to configure a client so that it transmits an SSO token in place of a username and a password.

## Username/password authentication without SSO

Figure 42 gives an overview of ordinary username/password-based authentication without SSO. In this case, the username, `<username>`, and password, `<password>`, are passed directly to the target server, which then contacts the Artix security service to authenticate the username/password combination.

**Figure 42:** Overview of Username/Password Authentication without SSO

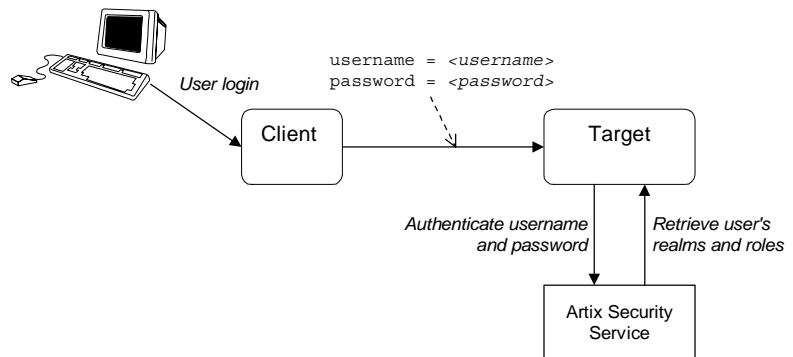

## Username/password authentication with SSO

Figure 43 gives an overview of username/password-based authentication when SSO is enabled.

**Figure 43:** Overview of Username/Password Authentication with SSO

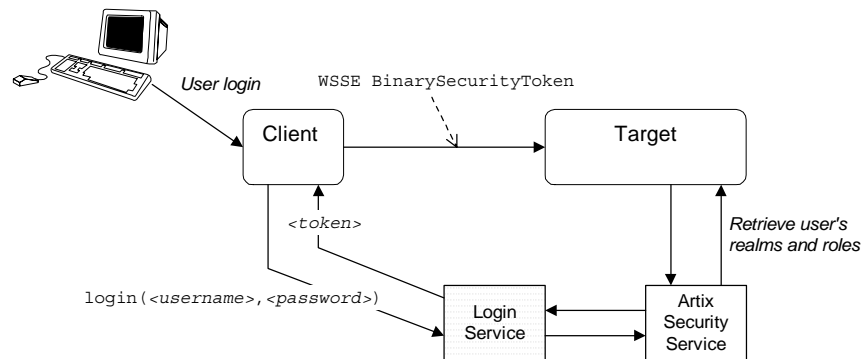

Prior to contacting the target server for the first time, the client Bus sends the username, `<username>`, and password, `<password>`, to the login server, getting an SSO token, `<token>`, in return. The client Bus then includes an IONA-proprietary SOAP header (extension of WSS BinarySecurityToken) in the next request to the target server. The target server's Bus contacts the Artix security service to validate the SSO token passed in the WSS Binary SecurityToken.

## Client configuration

Example 78 shows a typical domain configuration for an SSO SOAP client that employs username/password authentication.

**Example 78:** SOAP Client Configuration for Username/Password-Based SSO

```

# Artix Configuration File
...
1 bus:initial_contract:url:login_service="../../wsdl/login_service
  .wsdl";
  plugins:login_client:shlib_name = "it_login_client";
  ...
  
```



**Example 78:** SOAP Client Configuration for Username/Password-Based SSO

```

sso_soap_client {
2   orb_plugins = ["xmlfile_log_stream", "iiop_profile", "giop",
3   "iiop", "soap", "http", "login_client", "artix_security"];
   binding:artix:client_request_interceptor_list=
   "login_client+security+principal_context";
   ...
};

```

The preceding Artix configuration can be described as follows:

1. The `bus:initial_contract:url:login_service` variable specifies the location of the Artix login service WSDL contract. You must edit this setting, if you store this contract at a different location.
2. The `orb_plugins` list must include the `login_client` plug-in. If the client uses a SOAP 1.2 binding, it is also necessary to include the `artix_security` plug-in in the `orb_plugins` list.
3. The Artix client request interceptor list must include the `login_client` interceptor. If the client uses a SOAP 1.2 binding, it is also necessary to include the `security` and `principal_context` interceptors in the order shown.

**Target configuration**

[Example 79](#) shows a typical domain configuration for an SSO SOAP target server that accepts connections from clients that authenticate themselves using username/password authentication.

**Example 79:** SOAP Target Configuration for Username/Password-Based SSO

```

# Artix Configuration File
...
sso_soap_target {
1   plugins:artix_security:shlib_name = "it_security_plugin";
   binding:artix:server_request_interceptor_list=
   "principal_context+security";
   binding:client_binding_list = ["OTS+POA_Coloc", "POA_Coloc",
2   "OTS+GIOP+IIOP", "GIOP+IIOP", "GIOP+IIOP_TLS"];
   orb_plugins = ["xmlfile_log_stream", "iiop_profile", "giop",
   "iiop_tls", "soap", "http", "artix_security"];

```

**Example 79:** SOAP Target Configuration for Username/Password-Based SSO

```

3     policies:asp:enable_authorization = "true";
        plugins:asp:authentication_cache_size = "5";
        plugins:asp:authentication_cache_timeout = "10";
        plugins:is2_authorization:action_role_mapping =
4     "file://C:\artix_20\artix\2.0\demos\security\single_signon\et
        c\helloworld_action_role_mapping.xml";
        plugins:asp:security_level = "REQUEST_LEVEL";
        principal_sponsor:use_principal_sponsor = "true";
        principal_sponsor:auth_method_id = "pkcs12_file";
        principal_sponsor:auth_method_data =
        ["filename=%{PRIVATE_CERT_1}",
        "password_file=%{PRIVATE_CERT_PASSWORD_FILE_1}"];
    };

```

The preceding Artix configuration can be described as follows:

1. The `security` interceptor must appear in the Artix server interceptor list to enable the `artix_security` plug-in functionality.
2. The `orb_plugins` list must include the `artix_security` plug-in.
3. You can enable SSO with or without authentication. In this example, the authentication feature is enabled.
4. The security level is set to `REQUEST_LEVEL`, implying that the username and password are extracted from the SOAP header.

**Artix login service configuration**

**Example 80** shows the domain configuration for an Artix login service that is integrated with the Artix security service (that is, both services run in the same process).

The configuration shown in **Example 80** can be characterised as follows:

- The *Artix security service* is accessible through the IIOP/TLS protocol, where the service is available on the host, localhost, and IP address, 55020.
- The *Artix login service* is accessible through the SOAP/HTTPS protocol, where the service's address is specified in the login service WSDL contract (see [“Login service WSDL configuration” on page 416](#)).

**Example 80: Artix Login Service Domain Configuration**

```

1 # Artix Configuration File
  include "../../../../../etc/domains/artix.cfg";

  secure_artix
  {
    single_signon
    {
2      initial_references:IT_SecurityService:reference =
        "corbaloc:it_iiops:1.2@localhost:55020/IT_SecurityService";

        security_service
        {
          orb_plugins = ["local_log_stream", "iiop_profile", "giop",
            "iiop_tls"];
          #event_log:filters = ["IT_SECURITY=WARN+ERROR+FATAL",
            "IT_JAVA_SERVER="];

          password_retrieval_mechanism:inherit_from_parent = "true";

3          principal_sponsor:use_principal_sponsor = "true";
          principal_sponsor:auth_method_id = "pkcs12_file";
          principal_sponsor:auth_method_data =
            ["filename=C:\Programs\artix_5.0/cxx_java/samples/security/ce
              rtificates/tls/x509/certs/services/administrator.p12",
              "password_file=C:\Programs\artix_5.0/cxx_java/samples/secureit
                y/certificates/tls/x509/certs/services/administrator.pwf"];
          policies:trusted_ca_list_policy =
            "C:\Programs\artix_5.0/cxx_java/samples/security/certificates
              /tls/x509/trusted_ca_lists/ca_list1.pem";

```

**Example 80:** *Artix Login Service Domain Configuration*

```

4     policies:target_secure_invocation_policy:requires =
      ["Confidentiality"];
      policies:target_secure_invocation_policy:supports =
      ["Confidentiality", "EstablishTrustInTarget",
      "EstablishTrustInClient", "DetectMisordering",
      "DetectReplay", "Integrity"];
      policies:client_secure_invocation_policy:requires =
      ["Confidentiality"];
      policies:client_secure_invocation_policy:supports =
      ["Confidentiality", "EstablishTrustInTarget",
      "EstablishTrustInClient", "DetectMisordering",
      "DetectReplay", "Integrity"];

5     generic_server_plugin = "java_server";
      plugins:java_server:shlib_name = "it_java_server";
6     plugins:java_server:class =
      "com.iona.jbus.security.services.SecurityServer";
      plugins:java_server:classpath =
      "C:\Programs\artix_5.0\cxx_java\lib\artix\security_service\5.
      0\security_service-rt.jar";
      plugins:java_server:jni_verbose = "false";
      plugins:java_server:X_options = ["rs"];

      plugins:security:direct_persistence = "true";

7     plugins:java_server:system_properties =
      ["org.omg.CORBA.ORBClass=com.iona.corba.art.artimpl.ORBImpl",
      "org.omg.CORBA.ORBSingletonClass=com.iona.corba.art.artimpl.O
      RBSingleton",
      "is2.properties=C:\Programs\artix_5.0\cxx_java\samples/securi
      ty/single_signon/etc/is2.properties.FILE",
      "java.endorsed.dirs=C:\Programs\artix_5.0\cxx_java/lib/endors
      ed"];
      plugins:local_log_stream:filename =
      "C:\Programs\artix_5.0\cxx_java\samples/security/single_signo
      n/etc/isf.log";

      policies:iiop:server_address_mode_policy:local_hostname =
      "localhost";
8     plugins:security:iiop_tls:addr_list = ["localhost:55020"];

9     policies:security_server:client_certificate_constraints=["CN=Orb
      ix2000 IONA Services (demo cert)"];
10    policies:external_token_issuer:client_certificate_constraints=[]
      ;

```

**Example 80:** *Artix Login Service Domain Configuration*

```

11     bus
12     {
13         orb_plugins = ["local_log_stream", "iiop_profile",
14         "giop", "iiop_tls", "artix_security", "login_service"];
15         binding:artix:server_request_interceptor_list=
16         "security";
17         bus:initial_contract:url:login_service =
18         "./login_service.wsdl";
19         plugins:asp:security_level = "REQUEST_LEVEL";
20         policies:asp:enable_authorization="false";
21
22         # secure HTTPS server -> secure HTTPS client settings
23         plugins:at_http:server:use_secure_sockets="true";
24         plugins:at_http:server:trusted_root_certificates =
25         "C:\Programs\artix_5.0\cxx_java\samples\security\certificates
26         /openssl/x509/ca/cacert.pem";
27         plugins:at_http:server:server_certificate =
28         "C:\Programs\artix_5.0\cxx_java\samples\security\certificates
29         /openssl/x509/certs/testaspen.pl2";
30         plugins:at_http:server:server_private_key_password =
31         "testaspen";
32
33         policies:target_secure_invocation_policy:requires =
34         ["Confidentiality"];
35         policies:target_secure_invocation_policy:supports =
36         ["Confidentiality", "Integrity", "DetectReplay",
37         "DetectMisordering", "EstablishTrustInClient",
38         "EstablishTrustInTarget"];
39     };
40 };
41 };

```

The preceding Artix configuration can be described as follows:

1. The included `artix.cfg` configuration file contains some generic configuration and settings required by all Artix programs.
2. The `IT_SecurityService` initial reference setting provides the endpoint details for connecting to the security service through the IIOP/TLS protocol. You should ensure that this setting is available in the scope of any CORBA application that needs to connect to the security service.

If you want to change the address of the Artix security service, you must edit the IP address in this initial reference and also the address specified in the `plugins:security:iiop_tls:addr_list` setting (see [8](#)).

3. The following `principal_sponsor` configuration settings are used to specify the Artix security service's own X.509 certificate. The `policies:trusted_ca_list_policy` setting is used to specify a list of trusted CA certificates.  
These settings are required in order to support the TLS protocol—see [“Configuring HTTPS and IIOP/TLS Authentication” on page 195](#) for more details.
4. The secure invocation policies specified in the following lines require both incoming and outgoing IIOP/TLS connections to be secure. For more details about SSL/TLS secure invocation policies, see [“Configuring Secure Associations” on page 241](#).
5. The core of the Artix security service is implemented as a pure Java program. To make the security service accessible through the IIOP/TLS protocol, the Java code is hosted inside an Artix generic server.
6. The `plugins:java_server:class` setting specifies the entry point for the Java implementation of the security service. The implementation defined by `com.ionajbus.security.services.SecurityServer` effectively acts as a *double container*. That is, it hosts two different kinds of service:
  - ◆ *CORBA-based security service*—the generic server wraps the security service in a CORBA wrapper layer, effectively making the security service accessible through the IIOP/TLS protocol. The configuration settings for this service are taken from the current configuration scope.
  - ◆ *Any Artix-based service*—the generic server instantiates an Artix Bus, which can be used to host *any* Artix-based service. The configuration settings for the Artix-based services are taken from the `bus` sub-scope of the current configuration scope.

7. This line sets the system properties for the Java implementation of the security service. In particular, the `is2.properties` property specifies the location of a properties file, which contains further property settings for the Artix security service.
8. The `plugins:security:iiop_tls:addr_list` setting is used to specify the IP address where the Artix security service listens for requests. If you want to change the address of the Artix security service, you must edit the IP address in this address list and also the initial reference specified in the `initial_references:IT_SecurityService:reference` setting (see 2).
9. The security service requires that any clients attempting to open a connection must present an X.509 certificate to identify themselves. In addition, the security service supports a primitive form of access control: client certificates will be rejected unless they conform to the constraints specified in `policies:security_server:client_certificate_constraints`. For details of how to specify certificate constraints, see [“Applying Constraints to Certificates” on page 605](#).

**Note:** The `policies:security_server:client_certificate_constraints` setting must be present in the security service’s configuration scope, otherwise the security service will not start.

10. The security service supports a special kind of access, where a client can obtain security tokens without providing a password, based on a username alone. This type of access is needed to support interoperability with the mainframe platform. Normally, however, this feature should be disabled to avoid opening a security hole. To disable the token issuer, set the token issuer’s certificate constraints to be an empty list (as shown here). This causes the token issuer to reject all clients, effectively disabling this feature.

**Note:** The `policies:external_token_issuer:client_certificate_constraints` setting must be present in the security service’s configuration scope, otherwise the security service will not start.

11. This line defines the start of the special `bus` sub-scope, which is used to configure Artix-based services that run inside the generic server's `Bus` instance.
12. The `orb_plugins` list must include the `artix_security` plug-in and the `login_service` plug-in.
13. The `security` interceptor must appear in the Artix server interceptor list to enable the `artix_security` plug-in functionality.
14. The `bus:initial_contract:url:login_service` variable specifies the location of the Artix login service WSDL contract. You must edit this setting, if you store this contract at a different location.
15. The security type setting selected here, `REQUEST_LEVEL`, implies that the login service preferentially reads the WSS UsernameToken and PasswordToken credentials from the incoming client request messages.
16. You must disable authorization in the login service. It is *not* appropriate for the login service to perform authorization checks on incoming requests (the login service does perform authentication, however).
17. The remaining settings in the `Bus` scope are the standard sort of settings you need for a service that uses the secure HTTPS protocol. For more details, see [“Configuring HTTPS and IIOP/TLS Authentication” on page 195](#).

### Login service WSDL configuration

**Example 81** shows an extract from the login service WSDL contract (in the directory, `cxx_java/samples/security/single_signon/etc`) showing details of the WSDL port settings.

#### **Example 81:** *Extract from the Login Service WSDL Configuration*

```
<definitions ... >
...
<service name="LoginService">
  <port binding="tns:LoginServiceBinding"
        name="LoginServicePort">
    <soap:address
      location="https://localhost:49675"/>
  </port>
</service>
```



**Example 81:** *Extract from the Login Service WSDL Configuration*

```
</definitions>
```

Note the following points about the WSDL port settings:

- The login service listens on a fixed host and port, `https://localhost:49675`. You will probably need to edit this setting before deploying the login service in a real system.  
However, you should *not* choose dynamic IP port allocation (for example, using `https://HostName:0`), because clients would not be able to discover the value of the dynamically allocated port.
- The address specified here uses the secure HTTPS protocol. Further security details are configured in the Artix configuration file.

**Related administration tasks**

---

For details of how to configure SSO token timeouts, see [“Configuring Single Sign-On Properties”](#) on page 331.



# Publishing WSDL Securely—C++ Runtime

*The WSDL publishing service enables clients to download WSDL contracts that are constructed from a server's in-memory WSDL model. In order to ensure the integrity of the WSDL contracts downloaded in this manner, Artix supports a number of special security features.*

---

**In this chapter**

This chapter discusses the following topics:

<a href="#">Introduction to the WSDL Publish Plug-In</a>	<a href="#">page 420</a>
<a href="#">Deploying WSDL Publish in a Container</a>	<a href="#">page 423</a>
<a href="#">Preprocessing Published WSDL Contracts</a>	<a href="#">page 427</a>
<a href="#">Enabling SSL/TLS for WSDL Publish Plug-In</a>	<a href="#">page 428</a>

---

# Introduction to the WSDL Publish Plug-In

---

## Overview

The Artix WSDL publishing service is packaged as a plug-in and can be loaded by any Artix server that needs to make its WSDL contracts available to remote clients. In particular, the WSDL publish plug-in provides a way of publishing endpoint information for services that have dynamically allocated IP ports.

Figure 44 provides an overview of the endpoints that can be used to access the WSDL publishing service. Because published WSDL contracts are constructed from the server's in-memory WSDL model, they also include volatile information, such as dynamically-allocated IP ports.

**Figure 44:** *Endpoints Used by the WSDL Publishing Service*

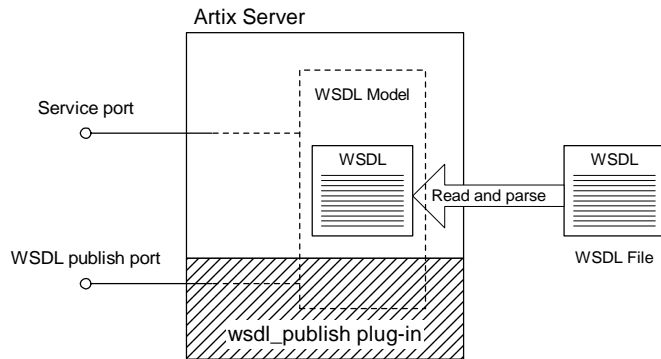

## Reference

For a detailed introduction to the Artix WSDL publishing service, see the relevant chapter in the *Deploying and Managing Artix Solutions* guide.

---

## Publishing WSDL

As shown in [Figure 44](#), the WSDL publishing service publishes WSDL contracts through two different kinds of endpoint, as follows:

- *Service-specific WSDL publish endpoints*—if the WSDL publish plug-in is enabled, the WSDL publishing service is automatically made available through any existing HTTP or HTTPS endpoints. In other words, the WSDL publishing service doubles up on existing service endpoints.
- *Dedicated WSDL publish endpoint*—in addition to the service-specific endpoints, the WSDL publish plug-in opens its own dedicated IP port for publishing WSDL.

---

## Security features

The WSDL publishing service has the following security features that provide protection for clients and servers:

- *Protection for clients*—there are two ways in which clients are protected:
  - ◆ *Secure connections to WSDL publish*—you can configure the WSDL publishing endpoints to be secured by SSL/TLS. This ensures that published WSDL contracts cannot be tampered with when they are retrieved by clients.
  - ◆ *Clients ignore downloaded client configuration*—some WSDL extensions allow you to configure client properties (for example, the location of a client's own X.509 certificate). Artix is designed to ignore client properties from downloaded WSDL contracts. Only local contracts can be used to configure the client.
- *Protection for servers*—some WSDL extensions might contain sensitive details about server configuration (for example, a server's private key password). To avoid exposing these details to clients, the WSDL publishing service automatically strips out server configuration details from the published WSDL contract.

---

**Loading the wsd1\_publish plug-in**

To load the `wsd1_publish` plug-in, add `wsd1_publish` to your `orb_plugins` list in the application's configuration scope. For example, if your server's configuration scope is `secure_server`, you might use the following `orb_plugins` list:

```
# Artix Configuration file
secure_server
{
    orb_plugins = [ ... , "wsd1_publish"];
    ...
};
```

---

**Enabling the dedicated WSDL publish endpoint**

To specify the IP port for the dedicated WSDL publish endpoint, set the `plugins:wsd1_publish:publish_port` variable in the application's configuration scope.

For example, use the following configuration to specify that a server opens a dedicated WSDL publish endpoint on the IP port, 2222:

```
# Artix Configuration file
secure_server
{
    orb_plugins = [ ... , "wsd1_publish"];
    plugins:wsd1_publish:publish_port = "2222";
    ...
};
```

# Deploying WSDL Publish in a Container

## Overview

Figure 45 shows the outline of a container with a secure WSDL publish plug-in deployed inside it. There are three kinds of endpoints in this example: the container endpoint (which is used to administer the container), Artix service endpoints, and a dedicated endpoint for the WSDL publishing service.

**Figure 45:** *WSDL Publish Plug-In Deployed in a Secure Container*

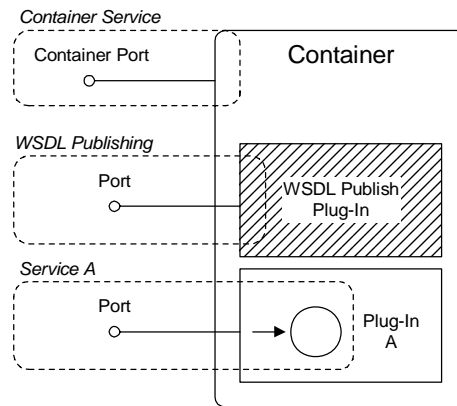

## Limitations of WSDL publish in a container

The WSDL publish plug-in is currently *not* compatible with running a container in mixed mode—that is, where some services are secure and other services insecure. When the WSDL publish plug-in is deployed in a container, every endpoint in the container must be secure. Specifically, the following endpoints must be secure:

- *WSDL publishing endpoint*—the dedicated WSDL publishing endpoint must be made secure by setting `plugins:wsl_publish:enable_secure_wsl_publish` to `true` and by setting `plugins:at_http:server:use_secure_sockets` to `true` (see “Configuring SSL/TLS for the WSDL publish endpoint” on page 429).

- *Container endpoint*—must be made secure by adding the appropriate settings to the Artix configuration file (see “Configuring the secure container” on page 69).
- *Artix service endpoints*—must be made secure, either by adding security settings to the Artix configuration file or to the service’s WSDL contract.

## How to deploy the WSDL publishing service

To deploy the WSDL publishing service into a secure container, modify the secure container configuration, as shown in the following example:

```
# Artix Configuration File
include "../../../../../etc/domains/artix.cfg";

secure_artix
{
    initial_references:IT_SecurityService:reference =
"corbaloc:it_iops:1.2@localhost:%{ISF_SECURE_PORT}/IT_SecurityService";

    secure_container
    {
        orb_plugins = [ ... , "wsdl_publish"];

        plugins:wsdl_publish:enable_secure_wsdl_publish = "true";
        plugins:at_http:server:use_secure_sockets = "true";
        plugins:wsdl_publish:publish_port = "2222";
        ...
    };
};
```

Where `wsdl_publish` is added to the `orb_plugins` list to load the WSDL publish plug-in. The `plugins:wsdl_publish:enable_secure_wsdl_publish` variable is set to `true` to make the WSDL publishing port secure. The `plugins:at_http:server:use_secure_sockets` variable enables HTTPS on the WSDL publishing port (this is required, because the WSDL publishing service uses HTTP by default). The `plugins:wsdl_publish:publish_port` variable specifies the WSDL publish dedicated port.

**Note:** In Artix versions 4.0 and earlier, the `plugins:wsdl_publish:publish_port` setting would be ignored and the container port value used instead.



**it\_container\_admin utility**

To connect to a secure container using the `it_container_admin` utility, perform the following steps:

1. The `it_container_admin` utility should be configured to support security. See [“Configuring the secure it\\_container\\_admin utility” on page 70](#) for an example of a suitable configuration.
2. Add `bus_entity_resolver` to the list of ORB plug-ins in the configuration scope used by the `it_container_admin` utility. For example:

```
ContainerAdmin
{
    orb_plugins = ["xmlfile_log_stream", "https",
                 "bus_entity_resolver"];
    ...
};
```

This ensures that the `it_container_admin` utility is able to parse the HTTPS URL published by `it_container`.

3. Run the container with the command-line options shown in the following example:

```
it_container -BUSname Container -port 1234 -publish
             -deploy DeployDescriptor.xml
```

Where `Container` is the name of the configuration scope for `it_container`. The `-port` option ensures that the container service listens on a fixed IP port. The `-publish` option causes the container to write an endpoint reference to the file, `ContainerService.url`, in the current directory (you can optionally use the `-file` option to specify the file name explicitly). The `-deploy` option is used to deploy an Artix service plug-in whose deployment descriptor is `DeployDescriptor.xml`.

4. You can use one of the following approaches to running the `it_container_admin` utility:
- ◆ *Specify the address of the WSDL publish service*—run the `it_container_admin` utility, using the `-host` and `-port` options to specify the address of the WSDL publish service, as follows:

```
it_container_admin -BUSname ContainerAdmin -host
ContainerHost -port WSDLPublishPort CommandOption
```

Where `ContainerAdmin` is the name of the configuration scope for `it_container_admin`. The `ContainerHost` is the host where the container process is running and `WSDLPublishPort` is the WSDL publish IP port value.

- ◆ *Specify the URL published by the container*—run the `it_container_admin` utility, using the `-container` option to specify the location of the `ContainerService.url` file from the previous step, as follows:

```
it_container_admin -BUSname ContainerAdmin -container
ContainerService.url CommandOption
```

The `ContainerService.url` file can be copied from the directory where it was generated by the container and `CommandOption` is one of the container administration commands (see *Configuring and Deploying Artix Solutions* for details of available commands).

---

# Preprocessing Published WSDL Contracts

---

## Overview

If you configure a server's security through the WSDL contract (for example, by setting security attributes on the `bus-security:security` element), you could potentially expose sensitive information to clients through the WSDL publishing mechanism.

To avoid opening a potential security hole, the `wSDL_publish` plug-in provides a preprocessing option to strip out server settings before publishing the WSDL contract. This option is enabled by default.

---

## Specifying WSDL preprocessing

You can use the `plugins:wSDL_publish:processor` variable to specify the kind of preprocessing done before publishing a WSDL contract.

Because published contracts are intended for client consumption, by default, all server-side WSDL artifacts are removed from the published contract. You can also require IONA-specific extensors to be removed. This variable has the following possible values:

<code>artix</code>	Remove server-side artifacts. This is the default setting.
<code>standard</code>	Remove server-side artifacts and IONA proprietary extensors.
<code>none</code>	Disable preprocessing

---

## Example configuration

[Example 82](#) shows a sample configuration for a secure server that selects the `standard` processing option for publishing WSDL contracts. This option ensures that all server related configuration and Artix specific tags are stripped from the WSDL contracts before publishing.

### **Example 82:** *Configuration for Preprocessing Published WSDL Contracts*

```
# Artix Configuration file
secure_server
{
    orb_plugins = [ ... , "wSDL_publish"];

    plugins:wSDL_publish:publish_port = "2222";
    plugins:wSDL_publish:processor = "standard";
    ...
};
```

---

# Enabling SSL/TLS for WSDL Publish Plug-In

---

## Overview

This section describes how to make the WSDL publishing service secure, by requiring clients to connect using the SSL/TLS protocol. The purpose of this feature is to protect clients from downloading WSDL contracts that have been tampered with. Without this security, a malicious user could intercept and modify the WSDL contract as it is being downloaded to the client.

## Securing import statements

If you are about to enable SSL/TLS for the WSDL publishing service, you should ensure that `wsdl:import` statements in your WSDL contracts locate imported contracts using a `https` URL instead of a `http` URL.

For example, if your contract includes a statement that imports the WS-Addressing schema, as follows:

```
<import namespace="http://www.w3.org/2005/08/addressing"
  schemaLocation="http://www.w3.org/2005/08/addressing/ws-addr.xsd" />
```

You would modify this import statement, changing the `schemaLocation` attribute to use a `https` URL, as follows:

```
<import namespace="http://www.w3.org/2005/08/addressing"
  schemaLocation="https://www.w3.org/2005/08/addressing/ws-addr.xsd" />
```

In addition, if any of the imported WSDL contracts themselves contain import statements, these recursive import statements must also be modified to use a `https` URL.

## Configuring SSL/TLS for a service-specific endpoint

If you configure an Artix service to use HTTPS, the `wsdl_publish` plug-in automatically makes the publishing service available through the same HTTPS endpoint. Because the publishing service is exposed through the same IP port as your Artix service, any security policies and settings that apply to the service endpoint automatically apply to connections made for the purpose of downloading WSDL contracts. Hence, you can make this publishing mechanism secure simply by configuring your service endpoints to be secure.

For details of how to secure service endpoints with HTTPS, see [“Securing HTTP Communications with TLS—C++ Runtime”](#) on page 103.

**Note:** Publishing WSDL through a service-specific endpoint is only possible, if the service runs over the HTTPS transport. Other transports are not supported.

## Configuring SSL/TLS for the WSDL publish endpoint

The WSDL publish plug-in also provides a dedicated HTTP port for publishing WSDL contracts. To make this port secure, you must explicitly enable security by setting the `plugins:wsl_publish:enable_secure_wsl_publish` configuration variable to `true` and the `plugins:at_http:server:use_secure_sockets` variable to `true`. To associate an X.509 certificate with this port, you can use the same configuration options as you would for a regular Artix endpoint (see [“Deploying Own Certificate for HTTPS—C++ Runtime”](#) on page 219).

[Example 83](#) shows a sample configuration of a secure WSDL publish endpoint that uses the HTTPS principal sponsor to specify an own certificate, `CertName.p12`.

### Example 83: Configuration for Secure WSDL Publish Endpoint

```
# Artix Configuration File
secure_server
{
    orb_plugins = [ ... , "wsl_publish", "at_http", "https"];

    plugins:wsl_publish:publish_port = "2222";
    plugins:wsl_publish:enable_secure_wsl_publish = "true";
    plugins:at_http:server:use_secure_sockets = "true";

    policies:target_secure_invocation_policy:requires =
["Confidentiality", "Integrity", "DetectReplay",
"DetectMisordering"];
    policies:target_secure_invocation_policy:supports =
["Confidentiality", "EstablishTrustInTarget",
"EstablishTrustInClient", "DetectMisordering",
"DetectReplay", "Integrity"];

    policies:https:trusted_ca_list_policy
="X509Deploy/ca/CACert.pem";

    principal_sponsor:https:use_principal_sponsor = "true";
```

**Example 83:** *Configuration for Secure WSDL Publish Endpoint*

```
principal_sponsor:https:auth_method_id = "pkcs12_file";
principal_sponsor:https:auth_method_data =
["filename=X509Deploy/certs/applications/CertName.p12"];
...
};
```

**Testing secure WSDL publishing**

To test the secure WSDL publishing service, you can try to connect to the service using an ordinary Web browser, as follows:

1. Configure your Artix server to enable secure WSDL publishing, as shown in [Example 83 on page 429](#). In this example, the server will open a dedicated WSDL publishing port at IP port 2222.
2. If your server requires mutual authentication (that is, requiring clients to send an X.509 certificate to the server), you must add a personal X.509 certificate to the Web browser's certificate store. The certificate must be signed by a CA that the server trusts.

For example, to install a personal X.509 certificate into Internet Explorer, do the following:

- i. Select **Tools | Internet Options** to open the **Internet Options** dialog.
- ii. Click the **Content** tab and then click the **Certificates** button. The **Certificates** dialog opens.
- iii. Click the **Personal** tab and then click the **Import** button to bring up the **Certificate Import Wizard**.
- iv. Follow the instructions in the **Certificate Import Wizard** to import a PKCS#12 format certificate (or other supported format) into the Internet Explorer certificate store.

**Note:** At the end of the import process, if the PKCS#12 certificate includes a CA certificate in its certificate chain, the import wizard will ask you whether you want to install that CA certificate as a trusted CA certificate.

3. Optionally, install the CA certificate that signed the server's certificates into the Web browser's certificate store.

If you do not install the CA certificate, you can still run the test.

However, in this case, when you attempt to connect to the server, your Web browser will warn you that the server's certificate is not trusted.

4. Start the Artix server.
5. Connect to the server's WSDL publish port using the Web browser. In the Web browser, enter the following secure URL address:

```
https://ServerHost:2222/get_wsdl?
```

Where *ServerHost* is the name of the host where the server is running (or *localhost*, if this is the same host where you are running the Web browser). After connecting to the WSDL publish port, you should see a page like the following:

**Figure 46:** HTML Page Served Up by the WSDL Publishing Service



6. You can also try a negative test—entering the URL address, `http://ServerHost:2222/get_wsdl?` into the browser—to verify that the WSDL publish port rejects insecure HTTP connections.





# Partial Message Protection—C++ Runtime

*Partial message protection refers to a range of features defined by the WS-Security specification that enable you to apply cryptographic operations at the level of the SOAP binding. The “partial” in partial message protection refers to the fact that cryptographic operations can be applied to parts of the message, instead of to the whole message.*

---

**In this chapter**

This chapter discusses the following topics:

<a href="#">Introduction to SOAP PMP</a>	<a href="#">page 434</a>
<a href="#">Setting Up a Java Keystore</a>	<a href="#">page 438</a>
<a href="#">Artix Configuration</a>	<a href="#">page 445</a>
<a href="#">Policy Configuration</a>	<a href="#">page 449</a>
<a href="#">Example of WSS Signing and Encryption</a>	<a href="#">page 470</a>
<a href="#">Exception Handling</a>	<a href="#">page 483</a>

---

# Introduction to SOAP PMP

---

## Overview

Artix partial message protection (PMP) is a suite of cryptographic capabilities that can be applied at the SOAP binding layer. The feature is based on the following WS-Security specification:

[WS-Security Core Specification 1.0](#)

In many respects, the capabilities offered by SOAP PMP parallel the capabilities offered by socket layer security, such as SSL/TLS. Like socket layer security, PMP provides confidentiality and integrity guarantees, based on X.509 certificates and asymmetric key technology. The key difference, however, is that PMP applies cryptographic operations at a *higher* level in the binding stack. Consequently, a smaller portion of the message is subjected to encryption operations. In particular, by leaving message headers unencrypted, PMP enables routers to process messages efficiently, while the message body itself remains safely encrypted.

---

## Features

Partial message protection offers the following features:

- Security at the level of a SOAP 1.1 binding.
  - Confidentiality and integrity support.
  - Secure SOAP messages independently of the transport layer.
  - Ability to send encrypted messages through plain HTTP firewall ports.
  - Ability to avoid the restrictions of point-to-point security.
  - Apply security policies to individual endpoints.
- 

## Limitations

Partial message protection is currently subject to the following limitations:

- Currently, cannot specify which part of message to protect (default is to protect the SOAP body of message).
- Supported only for the SOAP 1.1 binding.

## Architecture

The current implementation of PMP has the following architectural characteristics:

- PMP is implemented by the WSS plug-in.
- The WSS plug-in is implemented as an Artix Java plug-in, but can also be used in Artix C++ applications.
- The WSS plug-in can install two Java handlers, a *WSS client handler* and a *WSS server handler*, which are responsible for modifying incoming and outgoing messages on the client and server.

## Basic client-server scenario

The basic behaviour of PMP at run time can be illustrated by the client-server scenario shown in [Figure 47](#), which shows handlers installed on the client side and on the server side. In this example, messages are encrypted as they pass back and forth between the client and the server

**Figure 47:** *Basic Client-Server Scenario*

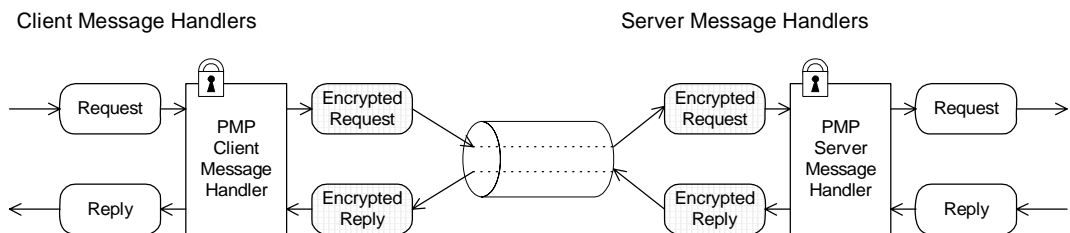

On the client side, the outgoing request passes along the chain of handlers until it reaches the PMP SOAP message handler, which encrypts the message's SOAP body.

On the server side, the incoming request message encounters the PMP SOAP message handler, which decrypts the SOAP message. The plaintext message then passes along the rest of the Java handler chain until it reaches the servant object.

The reply message is treated in a similar manner, except that the message progresses in the opposite direction, back to the client.

**Note:** Currently, SOAP headers are not protected; just the message body.

**Key distribution**

---

Artix employs a *Java keystore* repository to store the certificates and private keys for PMP—see “[Setting Up a Java Keystore](#)” on page 438.

Artix does not provide any tools for managing the distribution of keys and certificates in a large secure network, however. For managing certificates and keys in a large system, it is recommended that you install a public key infrastructure (PKI) tool from a third-party software vendor.

---

**Cryptographic operations**

Artix PMP currently supports the following basic cryptographic operations:

<i>Encrypt</i>	Encrypt the SOAP body of a message (that is, excluding the SOAP header).
<i>Sign</i>	Sign the SOAP body of a message (that is, excluding the SOAP header).
<i>Verify</i>	Verify the signature on the SOAP body of a message.
<i>Decrypt</i>	Decrypt the SOAP body of a message.

These basic cryptographic operations can be combined, to give the following composite cryptographic operations:

<i>Encrypt and Sign</i>	Encrypt and then sign the SOAP body.
<i>Sign and Encrypt</i>	Sign and then encrypt the SOAP body.
<i>Verify and Decrypt</i>	Verify signature and then decrypt the SOAP body.
<i>Decrypt and Verify</i>	Decrypt the SOAP body and then verify the signature.

The order of the constituent operations is important. Thus, a producer that performs *encrypt and sign* on an outgoing message must be complemented by a consumer that performs *verify and decrypt*. Likewise, the *sign and encrypt* operation is complemented by the *decrypt and verify* operation.

---

**Granularity of protection policies**

Artix PMP provides flexible options for specifying the granularity at which protection policies are applied. For example, you can apply policies at any of the following levels of granularity:

- All incoming and outgoing messages.
- All endpoints from a particular service.
- A single endpoint only.

- Outgoing messages only.
- Incoming messages only.
- Client or server role only.

Moreover, PMP lets you specify the granularity using a flexible system of rules and conditions. In particular, PMP supports a feature that lets you select service QNames and port names using *regular expression matching*. See [“Conditions” on page 467](#) for more details.

---

# Setting Up a Java Keystore

---

## Overview

The Artix PMP feature uses Java keystores as a repository for storing X.509 certificates and private keys. Before enabling PMP for your application, you need to understand how to create and manage Java keystores, as described in this section.

## Prerequisites

The Java keystore is a feature of the *Java platform Standard Edition (SE)* from Sun. To perform the tasks described in this section, you will need to install a recent version of the Java Development Kit (JDK) and ensure that the JDK `bin` directory is on your path. See <http://java.sun.com/javase/>.

## Default keystore provider

Sun's JDK provides a standard file-based implementation of the keystore. The instructions in this section presume you are using the standard keystore. If there is any doubt about the kind of keystore you are configured to use, check the following line in your `java.security` file (located either in `JavaInstallDir/lib/security` or `JavaInstallDir/jre/lib/security`):

```
keystore.type=jks
```

The `jks` (or `JKS`) keystore type represents the standard keystore.

## Customizing the keystore provider

Java also allows you provide a custom implementation of the keystore, by implementing the `java.security.KeystoreSpi` class. For details of how to do this see the following references:

- <http://java.sun.com/j2se/1.5.0/docs/tooldocs/windows/keytool.html>
- <http://java.sun.com/j2se/1.5.0/docs/guide/security/HowToImplAPProvider.html>

If you use a custom keystore provider, you should consult the third-party provider documentation for details of how to manage certificates and private keys with this provider.

## Keystore password

The keystore repository is protected by a *keystore password*, which is defined at the same time the keystore is created. Every time you attempt to access or modify the keystore, you must provide the keystore password.

---

## Keystore entries

The keystore provides two distinct kinds of entry for storing certificates and private keys, as follows:

- *Key entries*—each key entry contains the following components:
  - ◆ A private key,
  - ◆ An X.509 certificate (can be v1, v2, or v3) containing the public key that matches this entry's private key.
  - ◆ Optionally, one or more CA certificates that belong to the preceding certificate's trust chain.

**Note:** The CA certificates belonging to a certificate's trust chain can be stored either in its key entry or in trusted certificate entries.

In addition, each key entry is tagged by an *alias* and protected by a *key password*. To access a particular key entry in the keystore, you must provide both the alias and the key password.

- *Trusted certificate entries*—each trusted certificate entry contains just a single X.509 certificate.

Each trusted certificate entry is tagged by an alias. There is no need to protect the entry with a password, however, because the X.509 certificate contains only a public key.

---

## How PMP uses keystore entries

The way in which Artix PMP uses Java keystores is slightly unconventional. This is because Java keystores were originally developed to support SSL/TLS protocols, which have slightly different requirements from PMP. In particular, PMP does *not* attempt to perform any authentication based on X.509 certificates (in contrast to the SSL/TLS family of protocols). Hence, PMP does not need to store trusted CA certificates, which is what the keystore's *trusted certificate entries* were originally devised for. PMP uses trusted certificate entries to store the X.509 certificates belonging to its peers.

To illustrate the way in which PMP uses keystores, consider the example shown in Figure 48, which shows two keystores used in a client-server application.

**Figure 48:** Overview of Keystores for a Client-Server Application

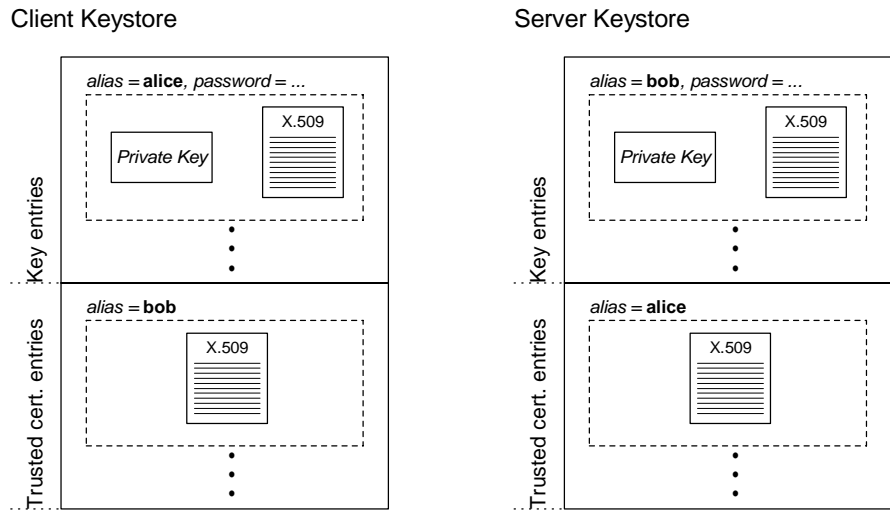

In this example, the keystores are set up as follows:

- *Client keystore*—stores the following entries:
  - ◆ A *key entry*, containing the X.509 certificate identified as `alice` and its matching private key. This private key is used to sign outgoing requests and to decrypt incoming replies.
  - ◆ A *trusted certificate entry*, containing the X.509 certificate identified as `bob`. This public key is used to verify incoming replies and to encrypt outgoing requests.
- *Server keystore*—stores the following entries:
  - ◆ A *key entry*, containing the X.509 certificate identified as `bob` and its matching private key. This private key is used to sign outgoing replies and to decrypt incoming requests.



- ◆ A *trusted certificate entry*, containing the X.509 certificate identified as `alice`. This public key is used to verify incoming requests and to encrypt outgoing replies.

---

## Keystore utilities

The Java platform SE provides two keystore utilities: `keytool` and `jarsigner`. Only the `keytool` utility is needed here.

---

## Generating certificates and keys using `keytool`

To generate the sample certificates and keys shown in [Figure 48 on page 440](#) using the `keytool` utility, perform the following steps:

1. In this example, you create two keystores: a client keystore and a server keystore. Create a directory, `KeystoreDir`, to hold the keystores you are about to create.
2. Open a command prompt and change directory to `KeystoreDir`. Enter the following command:

```
keytool -genkey -dname "CN=Alice, OU=Engineering, O=IONA
Technologies, C=IE" -validity 365 -alias alice -keypass
password -keystore client.jks -storepass password
```

This `keytool` command, invoked with the `-genkey` option, generates an X.509 certificate and a matching private key for the client. The certificate and key are both placed in a key entry in a newly created keystore, `client.jks`. Because the specified keystore, `client.jks`, did not exist before issuing the command, `keytool` implicitly creates a new keystore.

The options specified to the preceding `keytool` command have the following meaning:

- ◆ `-genkey` option—selects the command to generate a self-signed X.509 certificate and its associated private key, placing both of these items in a single key entry in the keystore.
- ◆ `-dname` and `-validity` options—specify the minimum amount of information needed for an X.509 certificate. The `-dname` specifies the distinguished name (DN) of the certificate owner (see [“ASN.1](#)

and Distinguished Names" on page 731 for a detailed explanation). The `-validity` option specifies the number of days before the certificate expires.

**Note:** The `keytool` command also supports `-keyalg`, `-keysize`, and `-sigalg` options for selecting the algorithms to generate keys and to sign the certificate.

- ◆ `-alias` and `-keypass` options—control access to the newly created key entry. The `-alias` option specifies a tag that is used to access the key entry. The `-keypass` option specifies a corresponding password that protects access to the private key in the key entry.
  - ◆ `-keystore` and `-storepass` options—you must always specify these options to access the keystore. The `-keystore` option specifies the location of the keystore file. If the option references a non-existent file, `keytool` creates a new keystore with the given file name (if appropriate). The `-storepass` specifies the password that protects access to the keystore.
3. To generate an X.509 certificate and a matching private key for the server, enter the following command:

```
keytool -genkey -dname "CN=Bob, OU=Engineering, O=IONA
Technologies, C=IE" -validity 365 -alias bob -keypass
password -keystore server.jks -storepass password
```

4. To export the client certificate to a file, `alice.cert`, enter the following command:

```
keytool -export -alias alice -file alice.cert -keystore
client.jks -storepass password
```

The file, `alice.cert`, will contain the client's exported X.509 certificate in a binary format (just the certificate, not the private key). It is not necessary to specify the key password (`-keypass` option), because the private key is not accessed.

- To export the server certificate to a file, `bob.cert`, enter the following command:

```
keytool -export -alias bob -file bob.cert -keystore
server.jks -storepass password
```

- To import the server certificate file, `bob.cert`, into the client keystore, enter the following command:

```
keytool -import -alias bob -file bob.cert -keystore
client.jks -storepass password
```

Before importing the certificate into the keystore, the `keytool` prompts you whether to accept the new certificate or not, as follows:

```
Owner: CN=Bob, OU=Engineering, O=IONA Technologies, C=IE
Issuer: CN=Bob, OU=Engineering, O=IONA Technologies, C=IE
Serial number: 45261b85
Valid from: Fri Oct 06 10:01:57 BST 2006 until: Sat Oct 06
10:01:57 BST 2007
Certificate fingerprints:
MD5: B6:52:53:54:1E:DD:A6:6A:86:58:B5:61:90:9C:B8:A3
SHA1:
56:F3:88:11:FB:33:19:DA:1A:AB:0A:56:EC:91:3E:AD:CE:5B:D1
:6F
Trust this certificate? [no]:
```

Enter `y` to accept the certificate.

The `keytool` then imports the server certificate (alias `bob`) into a trusted certificate entry in the client's keystore, as shown in [Figure 48 on page 440](#).

**Note:** Whenever you import a certificate using a new alias, the `keytool` automatically presumes you want to import the certificate into a trusted certificate entry.

- To import the client certificate file, `alice.cert`, into the server keystore, enter the following command:

```
keytool -import -alias alice -file alice.cert -keystore
server.jks -storepass password
```

The `keytool` then imports the client certificate (alias `alice`) into a trusted certificate entry in the server's keystore, as shown in [Figure 48 on page 440](#).

---

# Artix Configuration

---

## Overview

To enable the partial message protection feature, you need to add some settings to the Artix configuration file, as described here. This section discusses the following topics:

- [Loading the WSS plug-in.](#)
- [Enabling client-side functionality.](#)
- [Enabling server-side functionality.](#)
- [Specifying a keystore.](#)
- [Specifying a policy configuration file.](#)
- [Logging.](#)
- [Customizing the keystore.](#)

---

## Loading the WSS plug-in

To load the WSS plug-in, your bus configuration should include settings similar to those shown in [Example 84](#).

### **Example 84:** *Configuration to Load the WSS Plug-In*

```
# Artix Configuration File
orb_plugins = [ ... , "java"];
java_plugins = ["wss"];
plugins:wss:classname =
    "com.iona.jbus.security.wss.plugin.BusPlugInFactory";
```

The WSS plug-in is implemented as a Java Artix plug-in. To enable Java plug-ins, you must include the `java` plug-in in the `orb_plugins` list. The `wss` plug-in is then listed in the `java_plugins` list. The `plugins:wss:classname` variable specifies the Java class that implements the WSS plug-in.

---

## Enabling client-side functionality

The client-side functionality is enabled by adding the `wss` handler to the client handler chain, as shown in [Example 85](#).

### **Example 85:** *Configuration to Enable Client-Side Functionality*

```
# Artix Configuration File
binding:artix:client_message_interceptor_list= "wss";
```

If more than one client interceptor is installed, the `wss` handler should be the *last* one in the list (closest to the transport layer).

### Enabling server-side functionality

The server-side functionality is enabled by adding the `wss` handler to the server handler chain, as shown in [Example 86](#).

#### Example 86: Configuration to Enable Server-Side Functionality

```
# Artix Configuration File
binding:artix:server_message_interceptor_list= "wss";
```

If more than one server interceptor is installed, the `wss` handler should be the *first* one in the list (closest to the transport layer).

### Specifying a keystore

You must associate the WSS plug-in with a Java keystore in order to access X.509 certificates and keys (see [“Setting Up a Java Keystore” on page 438](#)). Specify the keystore using the settings shown in [Example 87](#).

#### Example 87: Configuration to Specify a Keystore

```
# Artix Configuration File
plugins:wss:keyretrieval:keystore:file="KeystoreDir/Keystore.jks";
plugins:wss:keyretrieval:keystore:storepass="StorePassword";
```

This configuration specifies a keystore file, `Keystore.jks`, which is located in the `KeystoreDir` directory. The password, `StorePassword`, specifies the password needed to access the keystore.

**WARNING:** Because these configuration settings include a password, you must be careful to set the file permissions appropriately on the Artix configuration file. You need to ensure that both the confidentiality and the integrity of the password data are protected.

## Specifying a policy configuration file

A *policy configuration file* specifies policies that govern encryption and integrity in the context of the partial message protection feature. To specify the location of the policy configuration file, *PolicyDir/PolicyFile.xml*, add the configuration setting shown in [Example 88](#).

### Example 88: Specifying a Policy Configuration File

```
# Artix Configuration File
plugins:wss:protection_policy:location="PolicyDir/PolicyFile.xml
";
```

This configuration setting is used both on the client side and on the server side. For details about the policy configuration file, see [“Policy Configuration” on page 449](#).

## Logging

For diagnostic purposes, you can optionally enable logging for the WSS plug-in by modifying your configuration as follows:

```
# Artix Configuration File
orb_plugins = ["xmlfile_log_stream", ... ];
event_log:filters=["MESSAGE_SNOOP=*",
  "IT_BUS.SERVICE.SECURITY.WSS=*"];
```

The `xmlfile_log_stream` plug-in writes logging data to a local XML file. For more details about Artix logging, see the [Artix Configuration Reference](#).

**Note:** You should only enable this logging for testing purposes, because it can have a significant impact on performance.

**Note:** In Artix 4.2, the logging subsystem ID has changed to `IT_BUS.SERVICE.SECURITY.WSS`. Previously, in Artix 4.1, the logging subsystem ID was `IT.SECURITY.WSS`.

## Customizing the keystore

The Java keystore system allows you to provide a custom implementation of the keystore (see [“Customizing the keystore provider” on page 438](#)). If you want to take advantage of this feature, you need to tell the WSS plug-in what type of keystore to use by setting the

```
plugins:wss:keyretrieval:keystore:provider and
plugins:wss:keyretrieval:keystore:storetype variables.
```

For example, to specify that you are using the standard JKS keystore implementation from Sun, you can specify the following settings:

```
# Artix Configuration File
plugins:wss:keyretrieval:keystore:provider="SunJCE";
plugins:wss:keyretrieval:keystore:storetype="jks";
```

There is no need to set these configuration variables, however, if you are using the standard JKS store type, as shown here.



---

# Policy Configuration

## Overview

---

This section describes how to configure the settings in a policy configuration file, which is responsible for defining the cryptographic operations performed on incoming and outgoing SOAP messages in the context of partial message protection.

---

## In this section

This section contains the following subsections:

<a href="#">Introduction to Policy Configuration</a>	page 450
<a href="#">Action Definitions</a>	page 452
<a href="#">Action Properties</a>	page 459
<a href="#">Protection Policy Definitions</a>	page 463
<a href="#">Conditions</a>	page 467

---

## Introduction to Policy Configuration

---

**Overview**

The policies that govern Artix partial message protection are specified in an XML file, the *policy configuration file*. By specifying protection policies in this file, you can decide which security guarantees are applied and when they should be applied. For example, you could use a protection policy to specify that all SOAP messages sent to a specific endpoint must be encrypted.

**Protection policy schema**

A complete XML schema for the policy configuration file is available at the following location:

*ArtixInstallDir/cxx\_java/schemas/protection-policy.xsd*

**Structure of policy configuration file**

A typical policy configuration file would have the overall structure shown in [Example 89](#).

**Example 89:** *Structure of a Policy Configuration File*

```
<?xml version='1.0' encoding='utf-8'?>
<itsp:ProtectionPolicyType
  xmlns:xs="http://www.w3.org/2001/XMLSchema"
  xmlns:xsi="http://www.w3.org/2001/XMLSchema-instance"
  xmlns:itsp="http://www.iona.com/security/wss/policy">

  <ActionDef name="...">
    <NameValuePair name="..."> ... </NameValuePair>
    ...
  </ActionDef>

  <ActionDef name="...">
    <NameValuePair name="..."> ... </NameValuePair>
    ...
  </ActionDef>
  ...
  <MessageProductionPolicy>
    <Rule>
      <ConditionSet> ... </ConditionSet>
      ...
      <ActionRef ref="..."></ActionRef>
      ...
    </Rule>
```

**Example 89:** *Structure of a Policy Configuration File*

```

</MessageProductionPolicy>

<MessageConsumptionPolicy>
  <Rule>
    <ConditionSet> ... </ConditionSet>
    ...
    <ActionRef ref="..."></ActionRef>
    ...
  </Rule>
</MessageConsumptionPolicy>
</itsp:ProtectionPolicyType>

```

Where the policy configuration file consists of a sequence of action definitions, which define specific cryptographic operations, followed by a *message production policy*, which defines rules that apply to outgoing messages, and a *message consumption policy*, which defines rules that apply to incoming messages.

**Confidentiality and integrity**

Currently, the following cryptographic operations or combinations of cryptographic operations are supported by partial message protection:

<i>Sign</i>	Sign the SOAP body of the message (that is, ignoring SOAP header content) using a private key.
<i>Encrypt</i>	Encrypt the SOAP body of the message using a public key.
<i>Encrypt and Sign</i>	A combination of cryptographic operations, where encryption precedes signing.
<i>Sign and Encrypt</i>	A combination of cryptographic operations, where signing precedes encryption.

Details of how to configure the cryptographic combinations are given in the following subsections.

---

## Action Definitions

---

### Overview

An action definition describes one atomic cryptographic operation (for example, sign the message using a particular key). The action definition on its own does not result in the specified behavior. When the action is referenced within a policy, however, the action can be triggered by the Artix runtime, provided that the appropriate conditions are fulfilled.

Structurally, action definitions are named sequences of name-value pairs, where the action name is a simple mnemonic that uniquely identifies the action definition for later reference in a policy.

---

### Producers and consumers

Instead of using the notions of a client role and a server role, action definitions and protection policies are defined with respect to a *producer role* and a *consumer role*, as follows:

- *Message producer*—the role describing an application program that emits a message. For example, a message producer could be a client program that sends a request, or a server program that sends a reply.
  - *Message consumer*—the role describing an application program that absorbs a message. For example, a message consumer could be a client program that receives a reply, or a server program that receives a request.
- 

### Action definitions for a message producer

On the message producer side, action definitions can be used to describe actions that protect messages—that is, encrypting and signing messages.

For example, the sequence of action definitions shown in [Example 90](#) describes how to encrypt a SOAP message body using the public key embedded in Bob's X.509 certificate and how to sign a SOAP message body using Alice's private key:

#### Example 90: Message Producer Action Definitions

```
<itsp:ProtectionPolicyType
  xmlns:xs="http://www.w3.org/2001/XMLSchema"
  xmlns:xsi="http://www.w3.org/2001/XMLSchema-instance"
  xmlns:itsp="http://www.iona.com/security/wss/policy">

  <ActionDef name="encrypt_to_bob">
```

**Example 90:** *Message Producer Action Definitions*

```

<NameValuePair name="protection">
  <Value xsi:type="xs:string">confidentiality</Value>
</NameValuePair>
<NameValuePair name="cert_info">
  <Value xsi:type="itsp:CertAliasType"
    alias="bob"/>
</NameValuePair>
</ActionDef>

<ActionDef name="sign_by_alice">
  <NameValuePair name="protection">
    <Value xsi:type="xs:string">integrity</Value>
  </NameValuePair>
  <NameValuePair name="key_info">
    <Value xsi:type="itsp:KeyAliasType"
      alias="alice" password="password"/>
  </NameValuePair>
</ActionDef>
...
</itsp:ProtectionPolicyType>

```

In the context of a message producer, the `confidentiality` value of the `protection` property is interpreted as an instruction to *encrypt* the outgoing message and the `integrity` value of the `protection` property is interpreted as an instruction to *sign* the outgoing message.

**Action definitions for a message consumer**

On the message consumer side, action definitions can be used to describe actions that unprotect messages—that is, decrypting and verifying messages.

For example, the sequence of action definitions shown in [Example 91](#) describes how to verify a SOAP message body using the public key embedded in Alice's X.509 certificate and how to decrypt a SOAP message body using Bob's private key:

**Example 91:** *Message Consumer Action Definitions*

```

<itsp:ProtectionPolicyType
  xmlns:xs="http://www.w3.org/2001/XMLSchema"
  xmlns:xsi="http://www.w3.org/2001/XMLSchema-instance"
  xmlns:itsp="http://www.iona.com/security/wss/policy">

  <ActionDef name="verify_from_alice">

```

**Example 91:** *Message Consumer Action Definitions*

```

<NameValuePair name="protection">
  <Value xsi:type="xs:string">integrity</Value>
</NameValuePair>
<NameValuePair name="cert_info">
  <Value xsi:type="itsp:CertAliasType"
    alias="alice"/>
</NameValuePair>
</ActionDef>

<ActionDef name="decrypt_to_bob">
  <NameValuePair name="protection">
    <Value xsi:type="xs:string">confidentiality</Value>
  </NameValuePair>
  <NameValuePair name="key_info">
    <Value xsi:type="itsp:KeyAliasType"
      alias="bob" password="password"/>
  </NameValuePair>
</ActionDef>
...
</itsp:ProtectionPolicyType>

```

In the context of a message consumer, the *integrity* value of the *protection* property is interpreted as an instruction to *verify* the incoming message and the *confidentiality* value of the *protection* property is interpreted as an instruction to *decrypt* the incoming message.

**Signature validation**

You can configure a message consumer to verify the signature on a received SOAP message in one of the following ways:

- [Referencing the producer's X.509 certificate.](#)
- [Referencing a list of producer X.509 certificates.](#)
- [Referencing a trusted CA.](#)

**Referencing the producer's X.509 certificate**

If the signed messages all originate from the *same* message producer, you can configure the message consumer to verify the signature by setting a *cert\_info* property that references the producer's X.509 certificate.

The prerequisites for this approach are as follows:

- The producer's X.509 certificate is cached in the local Java keystore,
- The message producer is configured to use the *issuer serial* signing option (see ["Issuer serial" on page 457](#)).

For example, to specify that signature validation is performed using Bob's public key, you can configure the action definition element as shown in [Example 92](#).

**Example 92:** *Signature Validation Using the cert\_info Property*

```
<ActionDef name="verify_from_bob">
  <NameValuePair name="protection">
    <Value xsi:type="xs:string">integrity</Value>
  </NameValuePair>
  <NameValuePair name="cert_info">
    <Value xsi:type="itsp:CertAliasType" alias="bob"/>
  </NameValuePair>
</ActionDef>
```

Where it is assumed that Bob's X.509 certificate is cached under the alias `bob` in the Java keystore on the message consumer side.

### Referencing a list of producer X.509 certificates

If the signed messages originate from *multiple* message producers, you can configure the message consumer to verify signatures by setting a `cert_info_list` property that references a list of producer X.509 certificates.

The prerequisites for this approach are as follows:

- The producer X.509 certificates are all cached in the local Java keystore,
- Message producers are configured to use the *issuer serial* signing option (see [“Issuer serial” on page 457](#)).

For example, to specify that signature validation is performed using either Bob or Alice’s public key, you can configure the action definition element as shown in [Example 93](#).

**Example 93:** *Signature Validation Using the cert\_info\_list Property*

```
<ActionDef name="verify_from_bob_or_alice">
  <NameValuePair name="protection">
    <Value xsi:type="xs:string">integrity</Value>
  </NameValuePair>
  <NameValuePair name="cert_info_list">
    <Value xsi:type="itsp:CertAliasListType">
      <CertAlias alias="bob"/>
      <CertAlias alias="alice"/>
    </Value>
  </NameValuePair>
</ActionDef>
```

Where the `cert_info_list` property consists of a sequence of zero or more `CertAlias` elements, each of which reference an X.509 certificate. It is assumed that Bob’s X.509 certificate is cached under the alias `bob` and Alice’s X.509 certificate is cached under the alias `alice`. The appropriate certificate is selected at runtime, based on the value of the issuer serial number transmitted by the message producer.

## Referencing a trusted CA

The approach described in [“Referencing a list of producer X.509 certificates”](#) is appropriate only for a fairly small number of message producers. If the number of message producers is *large*, it becomes impractical to cache the producer certificates on the consumer side. In this case, you can configure the message consumer to verify signatures by setting a `ca_info` property that references a trusted certificate authority (CA) certificate.

The prerequisites for this approach are as follows:

- The trusted CA certificate is cached in the local Java keystore,
- Every producer X.509 certificate is signed by the trusted CA certificate,
- Message producers are configured to use the *direct reference* signing option (see [“Direct reference” on page 458](#)).



In this scenario, the producer's X.509 certificate is transmitted directly to the consumer in a SOAP header. The consumer verifies the X.509 certificate (by checking that it is validly signed by the trusted CA certificate) and then uses the X.509 certificate to verify the SOAP message signature.

For example, to specify that signature validation can be performed using X.509 certificates signed by the trusted CA certificate, `trent`, configure the action definition element as shown in [Example 93](#).

**Example 94:** *Signature Validation Using the `ca_info` Property*

```
<ActionDef name="verify_issued_by_trent">
  <NameValuePair name="protection">
    <Value xsi:type="xs:string">integrity</Value>
  </NameValuePair>
  <NameValuePair name="ca_info">
    <Value xsi:type="itsp:CertAliasType"
      alias="trent"/>
  </NameValuePair>
</ActionDef>
```

Where the `ca_info` property has a value of `itsp:CertAliasType` type, whose `alias` attribute references the trusted CA certificate in the local Java keystore.

---

## Signing options

You can configure a message producer to transmit the identity of the public key required to verify a signed message, in one of the following ways:

- [Issuer serial](#).
- [Direct reference](#).

---

## Issuer serial

When you specify the *issuer serial* signing option, the message producer transmits the serial number of its X.509 certificate in a SOAP header. The message consumer then uses the serial number to identify which X.509 certificate to use when verifying the message signature. No special configuration is required to select this option—it is the default.

**Note:** The issuer serial signing option is compatible with either the `cert_info` or `cert_info_list` validation options on the consumer side.

**Direct reference**

When you specify the *direct reference* signing option, the message producer transmits its X.509 certificate in a SOAP header. The consumer checks, first of all, whether the producer's X.509 certificate is validly signed by a trusted CA certificate. If the certificate is validly signed, the consumer then uses it to verify the signature on the received SOAP message.

**Note:** The direct reference signing option is compatible *only* with the `ca_info` validation option on the consumer side.

To enable the direct reference signing option, add the `key_identifier` property to an action definition that defines message signing, as shown in [Example 95](#).

**Example 95:** *Enabling the Direct Reference Signing Option*

```
<ActionDef name="sign_by_alice.direct_reference">
  <NameValuePair name="protection">
    <Value xsi:type="xs:string">integrity</Value>
  </NameValuePair>
  <NameValuePair name="key_info">
    <Value xsi:type="itsp:KeyAliasType"
      alias="alice" password="password"/>
  </NameValuePair>
  <NameValuePair name="key_identifier">
    <Value xsi:type="xs:string">direct_reference</Value>
  </NameValuePair>
</ActionDef>
```

Where the `key_identifier` property is configured with the value, `direct_reference`. The `key_identifier` property must be used in combination with the `protection` and `key_info` properties in order to produce a well-defined action definition.

## Action Properties

### Overview

An *action property* is a property setting defined using `itsp:NameValuePair` elements inside an action definition. [Table 12](#) shows the set of action properties currently supported by the Artix partial message protection feature.

**Table 12:** *Properties of an Action Definition*

Property Name	Property Type	Allowed Values and Attributes
<a href="#">protection</a>	<code>xs:string</code>	Value string can be <code>confidentiality</code> OR <code>integrity</code> .
<a href="#">key_info</a>	<code>itsp:KeyAliasType</code>	Attribute <code>alias</code> specifies the alias of a key entry in the keystore. Attribute <code>password</code> specifies the corresponding key password.
<a href="#">cert_info</a>	<code>itsp:CertAliasType</code>	Attribute <code>alias</code> specifies the alias of a trusted certificate entry in the keystore.
<a href="#">cert_info_list</a>	<code>itsp:CertAliasListType</code>	A sequence of zero or more <code>CertAlias</code> elements.
<a href="#">ca_info</a>	<code>itsp:CertAliasType</code>	Attribute <code>alias</code> specifies the alias of a trusted CA certificate, which is stored in a trusted certificate entry in the keystore.
<a href="#">key_identifier</a>	<code>xs:string</code>	Value string can be <code>direct_reference</code> .
<a href="#">target</a>	<code>xs:string</code>	Value string is a SOAP actor.
<a href="#">must_understand</a>	<code>xs:string</code>	Value string can be <code>true</code> OR <code>false</code> .

**Setting a Value element**

The property name, type, value, and attributes (if any) are all specified in an `itsp:Value` element. Because the `Value` element is defined to be of `xs:anyType`, the pattern for setting a `Value` element depends on the particular type that it instantiates (as specified by the `type` attribute).

For example, consider a `Value` element that is specified to be of `itsp:KeyAliasType`. You would define such a `Value` element as follows:

```
<NameValuePair name="key_info">
  <Value xsi:type="itsp:KeyAliasType"
        alias="AliasValue" password="PassValue"/>
</NameValuePair>
```

The `alias` and `password` attributes belong to the definition of the `itsp:KeyAliasType` type.

**protection**

The `protection` property describes the cryptographic operation to perform. The allowable operations are, as follows:

- `confidentiality`—interpreted as *encrypt* on the producer side and *decrypt* on the consumer side, or
- `integrity`—interpreted as *sign* on the producer side and *verify* on the consumer side.

Within the enclosing `itsp:ActionDef` element, the `protection` property must be accompanied either by a `key_info` property (to gain access to a private key) or a `cert_info` property (to gain access to a public key).

**key\_info**

The `key_info` property references a private key stored in a key entry in the Java keystore (see [“Setting Up a Java Keystore” on page 438](#)). To access the private key, you must provide a key alias and a key password. The `Value` element that defines the `key_info` property is an instance of `itsp:KeyAliasType` type, which is defined by the following fragment of XML schema:

```
<complexType name="KeyAliasType">
  <sequence/>
  <attribute name="alias" type="string" use="required"/>
  <attribute name="password" type="string" use="required"/>
</complexType>
```

---

**cert\_info**

The `cert_info` property references an X.509 certificate stored in a trusted certificate entry in the Java keystore. You must provide a certificate alias for the referenced certificate. The `value` element that defines the `cert_info` property is an instance of `itsp:CertAliasType` type, which is defined by the following fragment of XML schema:

```
<complexType name="CertAliasType">
  <sequence/>
  <attribute name="alias" type="string" use="required"/>
</complexType>
```

---

**cert\_info\_list**

The `cert_info_list` property references zero or more X.509 certificates stored in trusted certificate entries in the Java keystore. Each referenced certificate is represented by a `CertAlias` element, which has an `alias` attribute to identify the certificate in the Java keystore. The `value` element that defines the `cert_info_list` property is an instance of `itsp:CertAliasListType`, which is defined by the following fragment of XML schema:

```
<complexType name="CertAliasListType">
  <sequence>
    <element
      name="CertAlias"
      type="tns:CertAliasType"
      minOccurs="0"
      maxOccurs="unbounded"
    />
  </sequence>
</complexType>
```

---

**ca\_info**

The `ca_info` property references a trusted CA certificate stored in a trusted certificate entry in the Java keystore. The `value` element that defines the `ca_info` property is an instance of `itsp:CertAliasType` type (see [“cert\\_info” on page 461](#)).

---

**key\_identifier**

The `key_identifier` property specifies how a message producer transmits the identity of the public key required to verify signed messages. The following options are supported:

- `direct_reference`—the message producer sends the X.509 certificate, which contains the key, directly in the message.

The `key_identifier` property is used in combination with the `protection` and `key_info` properties.

---

**target**

The `target` property describes the SOAP actor or role to whom the message protection is targeted. The value of this property can be any string (where an empty string is semantically equivalent to not specifying the property at all.)

If an action is used to cryptographically protect (sign or encrypt) a message, and the action contains this property, the resulting message will contain a WS-Security SOAP header with an `actor` attribute containing the designated value. This property allows applications to target cryptographic operations for specific SOAP entities (such as a router or other intermediary, for example).

If an action is used to cryptographically unprotect (verify or decrypt) a message, and the action contains this property, the unprotection operation will apply only to WS-Security SOAP headers that contain the specified target in the actor attribute. This property allows receiving applications (for example, a router) to process only those headers to whom it has targeted cryptographic operations.

---

**must\_understand**

This property specifies the value of the `mustUnderstand` attribute in WS-Security SOAP headers, when SOAP headers are inserted into SOAP messages as a result of signing or encryption operations.

The allowed values for this property are `true` or `false`.

Specifying `false` is semantically equivalent to not specifying any value, and results in no specification of the `mustUnderstand` attribute.

---

## Protection Policy Definitions

---

### Overview

Protection policies are evaluated at run time to determine which actions to perform, based on information available from the current execution context (such as the currently operational service QName and port name, as defined in WSDL). When the WSS plug-in intercepts a message, the information from the current execution context is combined with the protection policies to determine which cryptographic operations to perform.

Logically, a protection policy consists of a sequence of rules, which are evaluated in order, to determine which cryptographic operations to perform. When a rule fires, the referenced actions are performed in the defined order and the remaining rules are then skipped.

---

### Protection policy

Two different types of element define protection policies, as follows:

- `itsp:MessageProductionPolicy`—defines policies that apply to outgoing messages.
- `itsp:MessageConsumptionPolicy`—defines policies that apply to incoming messages.

Within a policy configuration file, a message production policy and a message consumption policy would be defined as shown in [Example 96](#).

#### Example 96: *Syntax of Protection Policy Elements*

```
<itsp:ProtectionPolicyType
  xmlns:xs="http://www.w3.org/2001/XMLSchema"
  xmlns:xsi="http://www.w3.org/2001/XMLSchema-instance"
  xmlns:itsp="http://www.iona.com/security/wss/policy">
  ...
  <MessageProductionPolicy>
    <Rule> ... </Rule>
    <Rule> ... </Rule>
    ...
  </MessageProductionPolicy>

  <MessageConsumptionPolicy>
    <Rule> ... </Rule>
    <Rule> ... </Rule>
    ...
  </MessageConsumptionPolicy>
```

**Example 96:** *Syntax of Protection Policy Elements*

```
</itsp:ProtectionPolicyType>
```

Where the `MessageProductionPolicy` element can appear at most once, the `MessageConsumptionPolicy` element can appear at most once, and the elements must appear in the order shown. Each of the policy elements can contain zero or more `Rule` elements, as discussed next.

**Rules**

A rule consists of a set of *conditions* and a list of *action references*. If all of the conditions are satisfied by the current execution context or if no conditions are specified, the listed actions are performed in the order in which they appear in the rule.

A policy rule is defined using an `itsp:Rule` element of the general form shown in [Example 97](#):

**Example 97:** *Syntax of a Rule Element*

```
<Rule>
  <ConditionSet> ... </ConditionSet>
  ...
  <ActionRef ref="..."/>
  <ActionRef ref="..."/>
  ...
</Rule>
```

The rule consists of an optional `ConditionSet` element followed by zero or more `ActionRef` elements. The `ConditionSet` element *must* precede the `ActionRef` elements and the order of the `ActionRef` elements is significant.

**Rule example**

The following example illustrates a simple rule definition with one condition and two action references:

```
<Rule>
  <ConditionSet>
    <NameValuePair name="port_name">
      <Value xsi:type="xs:string">SoapPort</Value>
    </NameValuePair>
  </ConditionSet>
  <ActionRef ref="encrypt_to_bob"></ActionRef>
  <ActionRef ref="sign_by_alice"></ActionRef>
</Rule>
```



If the current port name (from the current WSDL contract) is `SoapPort`, the rule performs the following actions:

1. The SOAP message body is encrypted using Bob's public key, and
2. The encrypted SOAP message body is then signed using Alice's private key.

## Conditions

A condition is a list of properties (represented as name-value pairs), whose values are compared with settings in the current execution context. The condition is satisfied when all of its properties match the current execution context. An absent condition evaluates to `true` by default.

A condition is defined using an `itsp:ConditionSet` element of the general form shown in [Example 98](#).

### Example 98: Syntax of a ConditionSet Element

```
<ConditionSet>
  <NameValuePair name="..."> ... </NameValuePair>
  <NameValuePair name="..."> ... </NameValuePair>
  ...
</ConditionSet>
```

The `ConditionSet` element can contain zero or more `NameValuePair` elements. Conditions are described in detail in ["Conditions" on page 467](#)

## Action references

An action reference is a reference to an action definition that appears within the same enclosing `ProtectionPolicyType` element. If no corresponding action definition is found, however, a runtime error occurs.

An action reference is defined using an `itsp>ActionRef` element of the general form shown in [Example 99](#).

### Example 99: Syntax of an ActionRef Element

```
<ActionRef ref="ActionName"/>
```

Where `ActionName` matches the `name` attribute from a previously defined `ActionDef` element.

**Rule evaluation algorithm**

It is possible for a protection policy to contain multiple rules, but only one of the rules is ever executed. Rules are evaluated at runtime by the WSS plug-in, using the following algorithm (in pseudo-code):

```
For each rule, R, in the protection policy {
  If all of the conditions in R are satisfied
  by the current execution context
  {
    Apply each action in R, in the order specified,
    to the message and then exit;
  }
  else
  {
    go to the next rule;
  }
}
```

Effectively, in a protection policy with multiple rules, Artix executes the first matching rule.

## Conditions

### Overview

Within a policy rule, each condition is represented by an `itisp:ConditionSet` element containing zero or more properties, where the properties are expressed as name-value pairs.

The supported condition properties are listed in [Table 13](#).

**Table 13:** *Condition Properties*

Property Name	Property Type	Allowed Values
<a href="#">service_qname</a>	<code>xs:string</code>	QName of a target service.
<a href="#">port_name</a>	<code>xs:string</code>	Port (or endpoint) name.
<a href="#">mode</a>	<code>xs:string</code>	client OR server.
<a href="#">bus_name</a>	<code>xs:string</code>	Name of the current Artix bus.

### [service\\_qname](#)

The `service_qname` property specifies a service QName, as it appears in a WSDL contract. The value of this property is a string of the form `{Namespace}LocalName`, where `Namespace` is the service QName namespace, and `LocalName` is the service QName local name. For example, consider the following `service_qname` property defined as a name-value pair:

```
<NameValuePair name="service_qname">
  <Value
    xsi:type="xs:string">{http://www.acme.com}MyService</Value>
</NameValuePair>
```

A condition with this property is satisfied, if and only if the value of the property matches the service QName of the current execution context.

---

**port\_name**

The `port_name` property specifies a service port (or endpoint) name, as it appears in a WSDL contract. The value of this property is a string. For example, consider the following `port_name` property defined as a name-value pair:

```
<NameValuePair name="port_name">
  <Value xsi:type="xs:string">SoapPort</Value>
</NameValuePair>
```

A condition with this property is satisfied, if and only if the value of the property matches the service port name of the current execution context.

---

**mode**

The `mode` property specifies whether the application program is acting as a client or as a server. The allowed values are `client` and `server`. For example, consider the following `mode` property defined as a name-value pair:

```
<NameValuePair name="mode">
  <Value xsi:type="xs:string">client</Value>
</NameValuePair>
```

A condition with this property is satisfied, if and only if the value of the property matches the current mode, `client` or `server`, of the current execution context.

---

**bus\_name**

The `bus_name` property specifies the Artix bus name in which the condition is evaluated. The value of this property may be any string. For example, consider the following `bus_name` property defined as a name-value pair:

```
<NameValuePair name="bus_name">
  <Value xsi:type="xs:string">my.bus.name</Value>
</NameValuePair>
```

A condition with this property is satisfied, if and only if the value of the property matches the bus name of the current execution context.

---

**Condition matching algorithm**

A condition value matches against a value in the current execution context, using one of the following mechanisms:

- [Case-sensitive matching](#).
- [Regular expression matching](#).

---

**Case-sensitive matching**

Condition values are compared to variables in the execution context using case-sensitive string-to-string comparison. This is the default.

---

**Regular expression matching**

Regular expression matching is automatically enabled whenever you use a special syntax for the condition value.

Condition values that use regular expression syntax take the following form:

```
regexp{Expr}
```

Where *Expr* is a regular expression, as described in <http://java.sun.com/j2se/1.4.2/docs/api/java/util/regex/Pattern.html>

For example, to match any port name that ends with the string `SecretSauce`, you would use the following property:

```
<NameValuePair name="port_name">  
  <Value xsi:type="xs:string">regexp{.*SecretSauce$}</Value>  
</NameValuePair>
```

---

# Example of WSS Signing and Encryption

## Overview

---

This section describes a simple example of partial message protection that provides a guarantee of confidentiality and integrity on all of the messages passing back and forth between a client and a server.

---

## In this section

This section contains the following subsections:

<a href="#">Basic Signing and Encryption Scenario</a>	<a href="#">page 471</a>
<a href="#">Configuring the Client</a>	<a href="#">page 473</a>
<a href="#">Configuring the Server</a>	<a href="#">page 478</a>

---

## Basic Signing and Encryption Scenario

---

### Overview

The scenario described here is a client-server application, where partial message protection is set up to encrypt and sign the SOAP body of messages that pass back and forth between the client and the server. This example is configured to use HTTP as the transport layer, but you could reconfigure the code to use any other supported transport instead.

---

### Demonstration code

Complete demonstration code for the scenario described here is available at the following location:

`ArtixInstallDir/cxx_java/samples/security/wss`

---

### Example scenario

Figure 49 shows an overview of the basic signing and encryption scenario, which is implemented by the WSS demonstration.

**Figure 49:** *Basic Signing and Encryption Scenario*

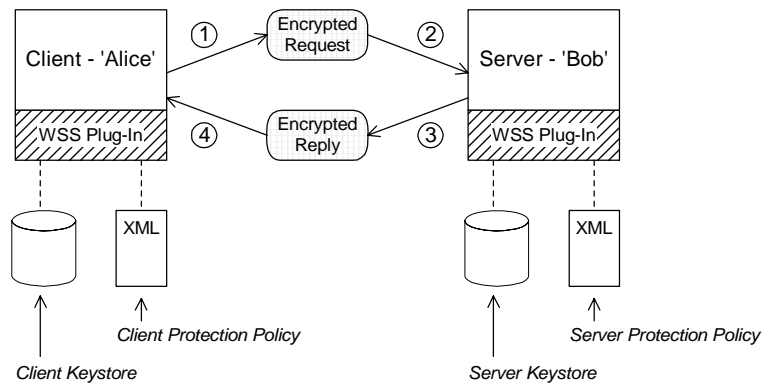

**Scenario steps**

---

When the client in [Figure 49](#) invokes a synchronous operation on the `SoapPort` endpoint, the request and reply message are processed as follows:

1. As the outgoing request message passes through the `wss` client handler, the handler processes the message in accordance with the policies specified in the client's protection policy file. In this example, the handler performs the following processing:
  - i. Encrypt the SOAP body of the message using Bob's public key.
  - ii. Sign the encrypted SOAP body using Alice's private key.
2. As the incoming request message passes through the `wss` server handler, the handler processes the message in accordance with the policies specified in the server's protection policy file. In this example, the handler performs the following processing:
  - i. Verify the signature using Alice's public key.
  - ii. Decrypt the SOAP body using Bob's private key.
3. As the outgoing reply message passes back through the `wss` server handler, the handler performs the following processing:
  - i. Encrypt the SOAP body of the message using Alice's public key.
  - ii. Sign the encrypted SOAP body using Bob's private key.
4. As the incoming reply message passes back through the `wss` client handler, the handler performs the following processing:
  - i. Verify the signature using Bob's public key.
  - ii. Decrypt the SOAP body using Alice's private key.



---

## Configuring the Client

---

### Overview

This subsection describes the configuration of the client from the WSS partial message protection demonstration. The following topics are discussed:

- [Setting up the client keystore.](#)
  - [Artix configuration.](#)
  - [Policy configuration.](#)
- 

### Setting up the client keystore

The client accesses its own Java keystore, which is set up as follows:

- *Key entries*—contains a single entry, with the following details:
  - ◆ *alias*—is `alice` and associated key password is `password`.
  - ◆ *private key*—Alice's private key.
  - ◆ *X.509 certificate*—containing Alice's public key.
- *Trusted certificate entries*—contains a single entry, with the following details:
  - ◆ *alias*— is `bob`.
  - ◆ *X.509 certificate*—containing Bob's public key.

For details of how to set up the client's keystore, see [“Setting Up a Java Keystore” on page 438](#).

---

### Artix configuration

[Example 100](#) shows the Artix configuration for a client that supports the partial message protection feature (implemented by the WSS plug-in).

#### Example 100: Artix Configuration for a PMP Client

```

1 include "../../../etc/domains/artix.cfg";

secure_artix
{
    wss
    {
2     orb_plugins = ["xmlfile_log_stream", "java"];
      java_plugins = ["wss"];
      plugins:wss:classname =
"com.iona.jbus.security.wss.plugin.BusPlugInFactory";

```

**Example 100: Artix Configuration for a PMP Client**

```

3     event_log:filters=["MESSAGE_SNOOP=*",
      "IT.SECURITY.WSS=*"];

      client
      {
4         binding:artix:client_message_interceptor_list= "wss";
5
      plugins:wss:keyretrieval:keystore:file="%{INSTALL_DIR}/%{PROD
      UCT_NAME}/%{PRODUCT_VERSION}/demos/security/wss/etc/keys/alice.
      e.jks";

      plugins:wss:keyretrieval:keystore:storepass="password";

6     plugins:wss:protection_policy:location="file://%{INSTALL_DIR}
      /%{PRODUCT_NAME}/%{PRODUCT_VERSION}/demos/security/wss/etc/cl
      ient_policy.xml";
      };
      };
};

```

The preceding Artix configuration can be explained as follows:

1. The standard `artix.cfg` configuration file contains default plug-in settings that are essential for most applications.
2. The client must be explicitly configured to load the `wss` Java plug-in. The following three lines load the `wss` plug-in, as described in [“Loading the WSS plug-in” on page 445](#).
3. You can optionally enable logging for the WSS plug-in, by including the `event_log:filters` setting shown here—see [“Logging” on page 447](#) for details.
4. In addition to loading the WSS plug-in, you must explicitly enable client-side functionality by installing the `wss` handler in the client handler list, as shown here. If there are multiple handlers in the list, the `wss` handler should appear last.
5. The `plugins:wss:keyretrieval:keystore` settings associate a Java keystore with the application—see [“Specifying a keystore” on page 446](#) for details.
6. The `plugins:wss:protection_policy:location` setting specifies the location of the policy configuration file for the client (discussed next).

## Policy configuration

[Example 101](#) shows the policy configuration for a client that supports the partial message protection feature.

**Example 101:** Policy Configuration File for a PMP Client

```

1 <?xml version='1.0' encoding='utf-8'?>
  <itsp:ProtectionPolicyType
    xmlns:xs="http://www.w3.org/2001/XMLSchema"
    xmlns:xsi="http://www.w3.org/2001/XMLSchema-instance"
    xmlns:itsp="http://www.iona.com/security/wss/policy">

    <!-- -->
    <!-- Action definitions -->
    <!-- -->

    <!-- Sign the SOAP Body using Alice's private key -->
2 <ActionDef name="sign_by_alice">
    <NameValuePair name="protection">
      <Value xsi:type="xs:string">integrity</Value>
    </NameValuePair>
    <NameValuePair name="key_info">
      <Value xsi:type="itsp:KeyAliasType"
        alias="alice" password="password"/>
    </NameValuePair>
  </ActionDef>

    <!-- Encrypt the SOAP Body using Bob's public key -->
3 <ActionDef name="encrypt_to_bob">
    <NameValuePair name="protection">
      <Value xsi:type="xs:string">confidentiality</Value>
    </NameValuePair>
    <NameValuePair name="cert_info">
      <Value xsi:type="itsp:CertAliasType"
        alias="bob"/>
    </NameValuePair>
  </ActionDef>

    <!-- Verify the signature on the SOAP Body using Bob's public
4 key -->
    <ActionDef name="verify_from_bob">
    <NameValuePair name="protection">
      <Value xsi:type="xs:string">integrity</Value>
    </NameValuePair>
    <NameValuePair name="cert_info">
      <Value xsi:type="itsp:CertAliasType"
        alias="bob"/>
    </NameValuePair>
  </ActionDef>

```

**Example 101: Policy Configuration File for a PMP Client**

```

        </NameValuePair>
    </ActionDef>

    <!-- Decrypt the SOAP Body using Alice's private key -->
5   <ActionDef name="decrypt_to_alice">
        <NameValuePair name="protection">
            <Value xsi:type="xs:string">confidentiality</Value>
        </NameValuePair>
        <NameValuePair name="key_info">
            <Value xsi:type="itsp:KeyAliasType"
                alias="alice" password="password"/>
        </NameValuePair>
    </ActionDef>

    <!-- -->
    <!-- Message Production Policy -->
    <!-- -->
6   <MessageProductionPolicy>
        <Rule>
            <ConditionSet>
                <NameValuePair name="port_name">
                    <Value xsi:type="xs:string">SoapPort</Value>
                </NameValuePair>
            </ConditionSet>
            <ActionRef ref="encrypt_to_bob"></ActionRef>
            <ActionRef ref="sign_by_alice"></ActionRef>
        </Rule>
    </MessageProductionPolicy>

    <!-- -->
    <!-- Message Consumption Policy -->
    <!-- -->
7   <MessageConsumptionPolicy>
        <Rule>
            <ConditionSet>
                <NameValuePair name="port_name">
                    <Value xsi:type="xs:string">SoapPort</Value>
                </NameValuePair>
            </ConditionSet>
            <ActionRef ref="verify_from_bob"></ActionRef>
            <ActionRef ref="decrypt_to_alice"></ActionRef>
        </Rule>
    </MessageConsumptionPolicy>

</itsp:ProtectionPolicyType>

```

The preceding policy configuration can be described as follows:

1. The `ProtectionPolicyType` element is the enclosing element for all of the policy definitions in the file. The `http://www.iona.com/security/wss/policy` namespace identifies IONA's proprietary XML schema that defines the format of the policy configuration. In this example, the namespace maps to the `itsp` namespace prefix.
2. The `sign_by_alice` action definition defines an action to sign the SOAP body of outgoing request messages—see [“Overview” on page 459](#) for more details.
3. The `encrypt_to_bob` action definition defines an action to encrypt the SOAP body of outgoing request messages.
4. The `verify_from_bob` action definition defines an action to verify the signature appearing on incoming reply messages. The signature would have been added to the SOAP body by the remote server endpoint.
5. The `decrypt_to_alice` action definition defines an action to decrypt the SOAP body of incoming reply messages.
6. The message production policy defines a single rule that defines the actions to take when the client is sending messages to the server. Given that the port name of the remote endpoint is `SoapPort`, the client applies the following actions to outgoing requests:
  - i. Encrypt the SOAP body of the message using Bob's public key, and
  - ii. Sign the encrypted SOAP body using Alice's private key.
7. The message consumption policy defines a single rule that defines the actions to take when the client receives messages from the server. Given that the port name of the remote endpoint is `SoapPort`, the client applies the following actions to incoming replies:
  - i. Verify the SOAP body of the message using Bob's public key, and
  - ii. Decrypt the SOAP body using Alice's private key.

---

## Configuring the Server

---

### Overview

This subsection describes the configuration of the server from the WSS partial message protection demonstration. The following topics are discussed:

- [Setting up the server keystore.](#)
  - [Artix configuration.](#)
  - [Policy configuration.](#)
- 

### Setting up the server keystore

The server accesses its own Java keystore, which is set up as follows:

- *Key entries*—contains a single entry, with the following details:
  - ◆ *alias*—is bob and associated key password is password.
  - ◆ *private key*—Bob's private key.
  - ◆ *X.509 certificate*—containing Bob's public key.
- *Trusted certificate entries*—contains a single entry, with the following details:
  - ◆ *alias*— is alice.
  - ◆ *X.509 certificate*—containing Bob's public key.

For details of how to set up the server's keystore, see [“Setting Up a Java Keystore” on page 438](#).

---

### Artix configuration

[Example 102](#) shows the Artix configuration for a server that supports the partial message protection feature (implemented by the WSS plug-in).

#### Example 102: Artix Configuration for a PMP Server

```
include "../../../../../etc/domains/artix.cfg";

secure_artix
{
    wss
    {
        orb_plugins = ["xmlfile_log_stream", "java"];
        java_plugins = ["wss"];
        plugins:wss:classname =
"com.iona.jbus.security.wss.plugin.BusPlugInFactory";
    }
}
```

**Example 102:** Artix Configuration for a PMP Server

```

event_log:filters=["MESSAGE_SNOOP=*"];

server
{
1       binding:artix:server_message_interceptor_list= "wss";
2
plugins:wss:keyretrieval:keystore:file="%{INSTALL_DIR}/%{PRODUCT_NAME}/%{PRODUCT_VERSION}/demos/security/wss/etc/keys/bob.jks";

3
plugins:wss:keyretrieval:keystore:storepass="password";

plugins:wss:protection_policy:location="file://%{INSTALL_DIR}/%{PRODUCT_NAME}/%{PRODUCT_VERSION}/demos/security/wss/etc/server_policy.xml";
};
};
};

```

The preceding Artix configuration can be explained as follows:

1. In addition to loading the WSS plug-in, you must explicitly enable server-side functionality by installing the `wss` handler in the server handler list, as shown here. If there are multiple handlers in this list, the `wss` handler should appear first.
2. The `plugins:wss:keyretrieval:keystore` settings associate a Java keystore with the application—see [“Specifying a keystore” on page 446](#) for details.
3. The `plugins:wss:protection_policy:location` setting specifies the location of the policy configuration file for the server (discussed next).

**Policy configuration**

[Example 103](#) shows the policy configuration for a server that supports the partial message protection feature.

**Example 103:** Policy Configuration File for a PMP Server

```

<?xml version='1.0' encoding='utf-8'?>
<itsp:ProtectionPolicyType
  xmlns:xs="http://www.w3.org/2001/XMLSchema"
  xmlns:xsi="http://www.w3.org/2001/XMLSchema-instance"
  xmlns:itsp="http://www.iona.com/security/wss/policy">

```

**Example 103:** Policy Configuration File for a PMP Server

```

<!-- -->
<!-- Action definitions -->
<!-- -->

<!-- Verify the signature on the SOAP Body using Alice's
public key -->
1 <ActionDef name="verify_from_alice">
    <NameValuePair name="protection">
        <Value xsi:type="xs:string">integrity</Value>
    </NameValuePair>
    <NameValuePair name="cert_info">
        <Value xsi:type="itsp:CertAliasType"
            alias="alice"/>
    </NameValuePair>
</ActionDef>

<!-- Decrypt the SOAP Body using Bob's private key -->
2 <ActionDef name="decrypt_to_bob">
    <NameValuePair name="protection">
        <Value xsi:type="xs:string">confidentiality</Value>
    </NameValuePair>
    <NameValuePair name="key_info">
        <Value xsi:type="itsp:KeyAliasType"
            alias="bob" password="password"/>
    </NameValuePair>
</ActionDef>

<!-- Sign the SOAP Body using Bob's private key -->
3 <ActionDef name="sign_by_bob">
    <NameValuePair name="protection">
        <Value xsi:type="xs:string">integrity</Value>
    </NameValuePair>
    <NameValuePair name="key_info">
        <Value xsi:type="itsp:KeyAliasType"
            alias="bob" password="password"/>
    </NameValuePair>
</ActionDef>

<!-- Encrypt the SOAP Body using Alice's public key -->
4 <ActionDef name="encrypt_to_alice">
    <NameValuePair name="protection">
        <Value xsi:type="xs:string">confidentiality</Value>
    </NameValuePair>
    <NameValuePair name="cert_info">

```



**Example 103:** Policy Configuration File for a PMP Server

```

        <Value xsi:type="itsp:CertAliasType"
            alias="alice"/>
    </NameValuePair>
</ActionDef>

<!-- -->
<!-- Message Production Policy -->
<!-- -->
5 <MessageProductionPolicy>
    <Rule>
        <ConditionSet>
            <NameValuePair name="port_name">
                <Value xsi:type="xs:string">SoapPort</Value>
            </NameValuePair>
        </ConditionSet>
        <ActionRef ref="encrypt_to_alice"></ActionRef>
        <ActionRef ref="sign_by_bob"></ActionRef>
    </Rule>
</MessageProductionPolicy>

<!-- -->
<!-- Message Consumption Policy -->
<!-- -->
6 <MessageConsumptionPolicy>
    <Rule>
        <ConditionSet>
            <NameValuePair name="port_name">
                <Value xsi:type="xs:string">SoapPort</Value>
            </NameValuePair>
        </ConditionSet>
        <ActionRef ref="verify_from_alice"></ActionRef>
        <ActionRef ref="decrypt_to_bob"></ActionRef>
    </Rule>
</MessageConsumptionPolicy>
</itsp:ProtectionPolicyType>

```

The preceding policy configuration can be described as follows:

1. The `verify_from_alice` action definition defines an action to verify the signature appearing on incoming request messages—see [“Overview” on page 459](#) for more details.
2. The `decrypt_to_bob` action definition defines an action to decrypt the SOAP body of incoming request messages.

3. The `sign_by_bob` action definition defines an action to sign the SOAP body of outgoing reply messages.
4. The `encrypt_to_alice` action definition defines an action to encrypt the SOAP body of outgoing reply messages.
5. The message production policy defines a single rule that defines the actions to take when the server is sending messages back to the client. Given that the current endpoint has the name, `SoapPort`, the endpoint applies the following actions to outgoing requests:
  - i. Encrypt the SOAP body of the message using Alice's public key, and
  - ii. Sign the encrypted SOAP body using Bob's private key.
6. The message consumption policy defines a single rule that defines the actions to take when the server receives messages from a client. Given that the current endpoint has the name, `SoapPort`, the endpoint applies the following actions to incoming requests:
  - i. Verify the SOAP body of the message using Alice's public key, and
  - ii. Decrypt the SOAP body using Bob's private key.

---

# Exception Handling

---

## Overview

Security error handling represents an exception to the rule that errors should be as informative as possible. You need to take into account that your system might be under attack and, thus, error messages should not provide information that would be useful to an attacker. Error handling under these circumstances represents a compromise between security requirements and diagnostic requirements.

There are two broad categories of failure that can affect an application secured by WS-Security:

- [Configuration errors](#)—which can render the WSS plug-in inoperable
  - [Runtime errors](#)—which result in a failed request or response
- 

## Configuration errors

Configuration errors are typically easy to detect and report. In general, a configuration error results in an immediate exception at plug-in initialization time (typically, though not necessarily, at Bus initialization time, though perhaps delayed until an interceptor chain is instantiated).

Certain configuration errors, though, can cause an application to fail at a later stage (for example, if the wrong keystore is accidentally configured). Such errors are treated as runtime errors.

---

## Runtime errors

Runtime errors always yield a SOAP fault exception

(`IT_Bus::FaultException` in C++, or

`javax.xml.rpc.soap.SOAPFaultException` in Java), which are propagated back to calling applications (or application clients). The fault codes returned by a `SOAPFaultException` fall into the following categories:

- [WS-Security fault codes](#).
- [IONA proprietary fault codes](#).

**WS-Security fault codes**

Table 14 shows the standard WS-Security fault codes and fault strings.

**Table 14:** *Standard WSS Fault Codes*

Fault Code	Fault String
<code>wsse:UnsupportedSecurityToken</code>	An unsupported token was provided.
<code>wsse:UnsupportedAlgorithm</code>	An unsupported signature or encryption algorithm was used.
<code>wsse:InvalidSecurity</code>	An error was discovered processing the <code>&lt;wsse:Security&gt;</code> header.
<code>wsse:InvalidSecurityToken</code>	An invalid security token was provided.
<code>wsse:FailedAuthentication</code>	The security token could not be authenticated or authorized.
<code>wsse:FailedCheck</code>	The signature or decryption was invalid.
<code>wsse:SecurityTokenUnavailable</code>	Referenced security token could not be retrieved.

**IONA proprietary fault codes**

Table 15 shows the IONA proprietary fault codes and fault strings.

**Table 15:** *IONA Proprietary Fault Codes*

Fault Code	Fault String
<code>{http://schemas.iona.com/security/wss}UnsatisfiedProtectionRequirement</code>	A protection requirement was not satisfied.

# Principal Propagation— C++ Runtime

*Principal propagation is a compatibility feature of Artix that is designed to facilitate interoperability with legacy Orbix applications.*

---

**In this chapter**

This chapter discusses the following topics:

<a href="#">Introduction to Principal Propagation</a>	page 486
<a href="#">Configuring</a>	page 487
<a href="#">Programming</a>	page 490
<a href="#">Interoperating with .NET</a>	page 493

---

# Introduction to Principal Propagation

---

## Overview

Artix principal propagation is a transport-neutral mechanism that can be used to transmit a secure identity from a client to a server. It is *not* recommended that you use this feature in new applications. Principal propagation is provided primarily in order to facilitate interoperability with legacy Orbix applications.

**WARNING:** By default, the principal is propagated across the wire in plaintext. Hence, the principal is vulnerable to snooping. To protect against this possibility, you should enable SSL for your application.

---

## Supported bindings/transports

Support for principal propagation is limited to the following bindings and transports:

- CORBA binding—the principal is sent in a GIOP service context.
- SOAP over HTTP—the principal is sent in a SOAP header.

**Note:** If a CORBA call is colocated, the principal is not propagated unless you remove the `POA_Colloc` interceptor from the binding lists in the `artix.cfg` file. This has the effect of disabling the CORBA colocated binding optimization.

---

## Interoperability

The primary purpose of Artix principal propagation is to facilitate interoperability with legacy Orbix applications, in particular for applications running on the mainframe.

Because Artix uses standard mechanisms to propagate the principal, this feature ought to be compatible with third-party products as well.

---

# Configuring

## Overview

This section describes how to configure Artix to use principal propagation. The following aspects of configuration are described:

- [CORBA](#).
- [SOAP over HTTP](#).
- [Routing](#).

**Note:** Principal configuration is not supported for any other bindings, apart from CORBA and SOAP over HTTP.

## CORBA

To use principal propagation with a CORBA binding, you must set the following configuration variables in your `artix.cfg` file (located in the `ArtixInstallDir/cxx_java/etc/domains` directory):

### Example 104: Configuring Principal Propagation for a CORBA Binding

```
policies:giop:interop_policy:send_principal = "true";
policies:giop:interop_policy:enable_principal_service_context =
"true";
```

You can either add these settings to the global scope or to a specific sub-scope (in which case you must specify the sub-scope to the `-BUSname` command line switch when running the Artix application).

## SOAP over HTTP

By default, the Artix SOAP binding will always add a principal header. The following cases arise:

- *Principal set explicitly*—the specified principal is sent in the principal header.
- *Principal not set*—Artix reads the username from the operating system and sends this username in the principal header.

If you use a SOAP 1.2 binding and you want a SOAP client to propagate a CORBA Principal to the target server, you must add some settings to the client's configuration, as shown in [Example 105](#).

**Example 105:** *Configuring Principal Propagation for SOAP in the Client*

```
# Artix Configuration File
orb_plugins = ["xmlfile_log_stream", "artix_security", ...];

binding:artix:client_request_interceptor_list =
    "security+principal_context";
```

If you want a SOAP server to authenticate a propagated principal using the Artix security service, you need to add some settings to the server's configuration scope in your `artix.cfg` file, as shown in [Example 106](#).

**Example 106:** *Configuring Principal Authentication for SOAP in the Server*

```
# Security Layer Settings
policies:asp:enable_authorization = "true";
plugins:is2_authorization:action_role_mapping =
    "file://C:\artix\artix\1.2\demos\secure_hello_world\http_soap
    /config/helloworld_action_role_mapping.xml";
plugins:asp:authorization_realm = "IONAGlobalRealm";

plugins:asp:security_level = "REQUEST_LEVEL";
plugins:asp:default_password = "default_password";
binding:artix:server_request_interceptor_list =
    "principal_context+security";
```

Setting `plugins:asp:security_level` equal to `REQUEST_LEVEL` specifies that the received principal serves as the username for the purpose of authentication. The `plugins:asp:default_password` value serves as the password for the purpose of authentication. This latter setting is necessary because, although the Artix security service requires a password, there is no password propagated with the principal.

**WARNING:** The procedure of supplying a default password for the principal enables you to integrate principals with the Artix security service. Users identified in this way, however, do *not* have the same status as properly authenticated users. For security purposes, such users should enjoy lesser privileges and be treated in the same way as unauthenticated users.



The `server_request_interceptor_list` setting is needed for the case where the CORBA Principal is transmitted inside a SOAP 1.2 message header.

The net effect of the configuration shown in [Example 106](#) is that the SOAP server performs authentication by contacting the central Artix security service. See also [“Security Layer” on page 62](#) and [“Configuring the Artix Security Service” on page 271](#) for more details about configuring the Artix security service.

---

## Routing

The Artix router automatically propagates the Principal from the route source to the route destination, as long as the bindings in the route are either CORBA or SOAP/HTTP.

# Programming

## Overview

This section describes how to program an Artix client and server to set (client side) and get (server side) a principal value.

The code examples are written using the contexts API. For more details about contexts, see *Developing Artix Applications in C++*.

## Client example

**Example 107** shows how to set the principal prior to invoking an operation, `echoString()`, on a proxy object, of `MyProxy` type.

### Example 107: Setting a Principal on the Client Side

```
// C++

#include <it_bus/bus.h>
#include <it_bus/exception.h>
#include <it_cal/iostream.h>

// Include header files related to the bus-security context
#include <it_bus_pdk/context.h>
#include <it_bus_pdk/context_attrs/context_constants.h>

IT_USING_NAMESPACE_STD

using namespace IT_ContextAttributes;
using namespace IT_Bus;

int
main(int argc, char* argv[])
{
    try
    {
        IT_Bus::Bus_var bus = IT_Bus::init(argc, argv);

        ContextRegistry* context_registry =
            bus->get_context_registry();

        // Obtain a reference to the ContextCurrent
        ContextCurrent& context_current =
            context_registry->get_current();
```

**Example 107: Setting a Principal on the Client Side**

```

1 // Obtain a pointer to the Request ContextContainer
ContextContainer* context_container =
    context_current.request_contexts();

// Set the principal context value
IT_Bus::String principal("artix_user");
context_container->set_context_as_string(
    PRINCIPAL_CONTEXT_ATTRIBUTE,
    principal
);
...
// Invoke the remote operation, echoString()
MyProxy echo_proxy;
echo_proxy.echoString("Echo me!")
}
catch(IT_Bus::Exception& e)
{
    cout << endl << "Error : Unexpected error occurred!"
        << endl << e.message()
        << endl;
    return -1;
}
return 0;
}

```

The preceding code can be explained as follows:

1. Call `IT_Bus::ContextContainer::set_context_as_string()` to initialize the string value of the principal context. The `IT_ContextAttributes::PRINCIPAL_CONTEXT_ATTRIBUTE` constant is a `QName` constant, initialized with the context name of the pre-registered principal context.

**Server example**

**Example 108** shows how to read the principal on the server side, when the servant is invoked by a client that uses principal propagation.

**Example 108: Reading the Principal on the Server Side**

```

// C++
// in operation
void MyImpl::echoString(const IT_Bus::String& inputString,
                       IT_Bus::String& Response)
IT_THROW_DECL((IT_Bus::Exception))
{
    Response = inputString;
    try {
        IT_Bus::Bus_var bus = IT_Bus::Bus::create_reference();

        ContextRegistry* context_registry =
            bus->get_context_registry();

        // Obtain a reference to the ContextCurrent
        ContextCurrent& context_current =
            context_registry->get_current();

        // Obtain a pointer to the Request ContextContainer
        ContextContainer* context_container =
            context_current.request_contexts();

        // Obtain a reference to the context
        IT_Bus::String & principal =
            context_container->get_context_as_string(
                PRINCIPAL_CONTEXT_ATTRIBUTE,
            );
        ...
    }
    catch(IT_Bus::Exception& e) { ... }
}

```

The preceding server example can be explained as follows:

1. The `IT_Bus::ContextContainer::get_context_as_string()` function returns the principal value that was extracted from the received request message.

---

# Interoperating with .NET

## Overview

---

If your Artix applications must interoperate with other Web service products, for example .NET, you need to modify your WSDL contract in order to make the principal header interoperable. This section describes the changes you can make to a WSDL contract to facilitate interoperability with other Web services platforms.

---

## In this section

This section contains the following subsections:

<a href="#">Explicitly Declaring the Principal Header</a>	<a href="#">page 494</a>
<a href="#">Modifying the SOAP Header</a>	<a href="#">page 496</a>

## Explicitly Declaring the Principal Header

### Overview

Artix applications do not require any modifications to the WSDL contract in order to use principal headers. An Artix service is inherently able to read a user's principal from a received SOAP header.

In contrast to this, non-Artix services, for example, .NET services, require the principal header to be declared *explicitly* in the WSDL contract. Otherwise, the non-Artix services would be unable to access the principal.

### Declaring the principal header in WSDL

Example 109 shows the typical modifications you must make to a WSDL contract in order to make the principal value accessible to non-Artix applications.

#### Example 109: WSDL Declaration of the Principal Header

```

<definitions ... >
  <types>
    <schema targetNamespace="TypeSchema" ... >
      ...
      1     <element name="principal" type="xsd:string"/>
      ...
    </schema>
  </type>
  ...
  2 <message targetNamespace="http://schemas.iona.com/security"
      name="principal">
  3   <part element="TypePrefix:principal" name="principal"/>
  </message>
  ...
  4 <binding ... xmlns:sec="http://schemas.iona.com/security">
      ...
  5   <operation ...>
      ...
      <input>
      <soap:body ...>
      6   <soap:header message="sec:principal"
          part="principal" use="literal">
          </input>
      </operation>
    </binding>
    ...
  </definitions>

```

The preceding WSDL extract can be explained as follows:

1. Declare a `principal` element in the type schema, which must be declared to be of type, `xsd:string`. In this example, the `principal` element belongs to the `TypeSchema` namespace.
2. Add a new `message` element.
3. The `<part>` tag's `element` attribute is set equal to the QName of the preceding `principal` element. Hence, in this example the `TypePrefix` appearing in `element="TypePrefix:principal"` must be a prefix associated with the `TypeSchema` namespace.
4. Edit the binding, or bindings, for which you might need to access the principal header. You should define a prefix for the `http://schemas.ionas.com/security` namespace within the `<binding>` tag, which in this example is `sec`.
5. Edit each operation for which you might need to access the principal header.
6. Add a `<soap:header>` tag to the operation's input part, as shown.

## Modifying the SOAP Header

### Overview

It is possible to change the default format of the principal header by making appropriate modifications to the WSDL contract. It is usually not necessary to modify the header format in this way, but in some cases it could facilitate interoperability.

### Default SOAP header

By default, when a client uses principal propagation with SOAP over HTTP, the input message sent over the wire includes the following form of header:

```
<SOAP-ENV:Header>
  <sec:principal xmlns:sec="http://schemas.ionas.com/security"
    xsi:type="xsd:string">my_principal</sec:principal>
</SOAP-ENV:Header>
```

### Custom SOAP header

You can change the form of the SOAP header that is sent over the wire to have the following custom format (replacing `<sec:principal>` by a custom tag, `<sec:PrincipalTag>`):

```
<SOAP-ENV:Header>
  <sec:PrincipalTag
    xmlns:sec="http://schemas.ionas.com/security"
    xsi:type="xsd:string">my_principal</sec:PrincipalTag>
</SOAP-ENV:Header>
```

### WSDL modifications

To change the tag that is sent in the SOAP header to be `PrincipalTag`, you can modify your WSDL contract as shown in [Example 110](#).

#### Example 110: Customizing the Form of the Principal Header

```
<definitions ... >
  <types>
    <schema targetNamespace="TypeSchema" ... >
      ...
      1      <element name="PrincipalTag" type="xsd:string"/>
      ...
    </schema>
  </type>
  ...
```



**Example 110:** Customizing the Form of the Principal Header

```

2      <message targetNamespace="http://schemas.iona.com/security"
          name="principal">
          <part element="TypePrefix:PrincipalTag"
name="principal"/>
        </message>
        ...
        <binding ... xmlns:sec="http://schemas.iona.com/security">
        ...
        <operation ...>
        ...
        <input>
        <soap:body ...>
3          <soap:header message="sec:principal"
              part="principal" use="literal">
        </input>
        </operation>
        </binding>
        ...
</definitions>

```

The preceding WSDL extract can be explained as follows:

1. Modify the `principal` element in the type schema to give it an arbitrary QName. In this example, the `<PrincipalTag>` element belongs to the `TypeSchema` namespace.
2. The `<part>` tag's `element` attribute is set equal to the QName of the preceding `principal` element. Hence, in this example the `TypePrefix` appearing in `element="TypePrefix:PrincipalTag"` must be a prefix associated with the `TypeSchema` namespace.
3. The `<soap:header>` tag must be defined precisely as shown here. That is, when writing or reading a principal header, Artix looks for the principal part of the message with QName, `principal`, in the namespace, `http://schemas.iona.com/security`.



# Bridging between SOAP and CORBA—C++ Runtime

*When a secure SOAP application interoperates with a secure CORBA application, it is often necessary to transform credentials between the two applications. For example, you might need to transform WSS username/password credentials embedded in a SOAP header into CSI username/password credentials embedded in a GIOP header.*

**In this chapter**

---

This chapter discusses the following topics:

<a href="#">SOAP-to-CORBA Scenario</a>	<a href="#">page 500</a>
<a href="#">Single Sign-On SOAP-to-CORBA Scenario</a>	<a href="#">page 516</a>
<a href="#">CORBA-to-SOAP Scenario</a>	<a href="#">page 523</a>

---

# SOAP-to-CORBA Scenario

**Overview**

---

This section describes how to integrate a secure SOAP client with a secure CORBA server, by interposing a suitably configured SOAP-to-CORBA Artix router. The router transforms the SOAP client's WSS username and password credentials into CSI/GSSUP credentials for the CORBA server.

---

**In this section**

This section contains the following subsections:

<a href="#">Overview of the Secure SOAP-to-CORBA Scenario</a>	<a href="#">page 501</a>
<a href="#">SOAP Client</a>	<a href="#">page 503</a>
<a href="#">SOAP-to-CORBA Router</a>	<a href="#">page 507</a>
<a href="#">CORBA Server</a>	<a href="#">page 513</a>

## Overview of the Secure SOAP-to-CORBA Scenario

### Overview

This subsection describes a secure SOAP-to-CORBA scenario, where the router is configured to integrate SOAP security with CORBA security. The key functionality provided by the router in this scenario is the ability to extract SOAP credentials (provided in the form of a WSS username and password) and propagate them as CORBA-compatible GSSUP credentials.

### SOAP-to-CORBA scenario

Figure 50 shows the outline of a scenario where WSS username and password credentials, embedded in a SOAP header, are transformed into GSSUP credentials, embedded in a GIOP service context.

**Figure 50:** *Propagating Credentials Across a SOAP-to-CORBA Router*

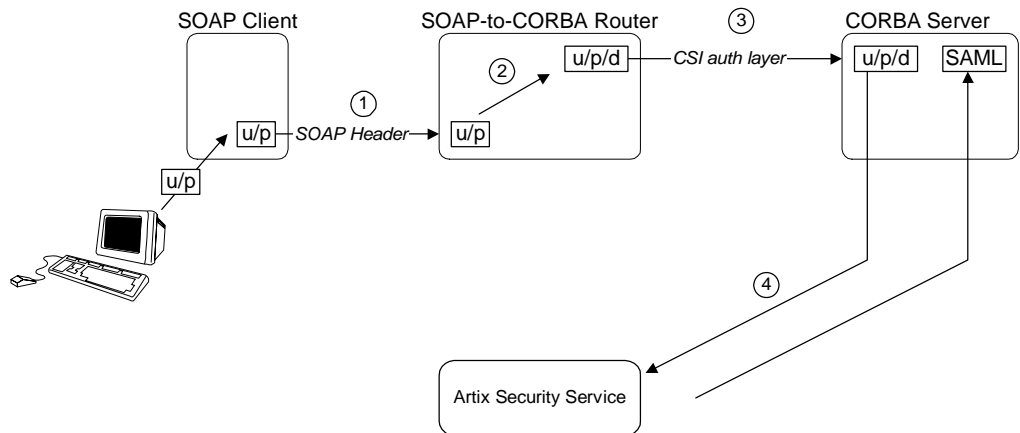

**Steps**

The steps for propagating credentials across the SOAP-to-CORBA router, as shown in [Figure 50](#), can be described as follows:

Stage	Description
1	The client initializes the WSS username and password credentials, <i>u/p</i> , and sends these credentials, embedded in a WSS SOAP header, across to the router.
2	The router extracts the received WSS username and password credentials, <i>u/p</i> , and transfers them into GSSUP credentials, consisting of username, password and domain, <i>u/p/d</i> . The username and password are copied straight into the GSSUP credentials. The domain is set to a blank string (which acts as a wildcard that matches any domain).
3	The GSSUP credentials, <i>u/p/d</i> , are sent on to the CORBA server using the CSI authentication over transport mechanism.
4	The CORBA server authenticates the received GSSUP credentials, <i>u/p/d</i> , by calling out to the Artix security service (this step is performed automatically by the <i>gss</i> plug-in).

**Demonstration code**

Demonstration code for this SOAP-to-CORBA scenario is available from the following location:

```
ArtixInstallDir/cxx_java/samples/security/secure_soap_corba
```

**Enabling GSSUP propagation**

To enable GSSUP propagation (where received username and password credentials are inserted into the outgoing GSSUP credentials by the router), set the following router configuration variable to `true`:

```
policies:bindings:corba:gssup_propagation = "true";
```

---

# SOAP Client

---

## Overview

When making an invocation, the SOAP client sends username and password credentials in a SOAP header (formatted according to the WSS standard). This section describes how to program and configure a SOAP client to send WSS username and password credentials.

---

## Choice of credentials

In this example, the SOAP client is programmed to send username/password credentials in the SOAP header. It is also possible, however, to send username/password credentials in the HTTP header, using the HTTP Basic Authentication mechanism. The propagation mechanism in the router supports either type of credentials.

---

## Setting the WSS username and password

[Example 111](#) shows how you can program a SOAP client to send username and password credentials using the WSS standard.

### **Example 111:** *SOAP Client Setting WSS Username/Password Credentials*

```
// C++
...
#include <it_bus_pdk/context.h>
#include <it_bus_pdk/context_attrs/context_constants.h>
#include <it_bus_pdk/context_attrs/bus_security_xsdTypes.h>
...
#include "HelloWorldClient.h"

IT_USING_NAMESPACE_STD

using namespace HW;
using namespace IT_Bus;
using namespace IT_ContextAttributes;

int
main(int argc, char* argv[] )
{
    try
    {
        IT_Bus::init(argc, argv);

1       Bus* bus = Bus::create_reference();
        ContextRegistry* registry = bus->get_context_registry();
```

**Example 111: SOAP Client Setting WSS Username/Password Credentials**

```

ContextCurrent& current = registry->get_current();
ContextContainer* request_contexts =
    current.request_contexts();

HelloWorldClient client;
BusSecurity* security_attr;
String* username;
String* token;
String string_out;
2 AnyType* output_attr = request_contexts->get_context(
    SECURITY_SERVER_CONTEXT,
    true
);

3 security_attr = dynamic_cast<BusSecurity*>(output_attr);
4 security_attr->setWSSEUsernameToken("user_test");
5 security_attr->setWSSEPasswordToken("user_password");
client.sayHi(string_out);
...
}
catch(IT_Bus::Exception& e)
{
    ... // Handle exception (not shown)
    return -1;
}
return 0;
}

```

The preceding client code can be explained as follows:

1. The following four lines contain the standard steps for obtaining a pointer to the request context container object, `request_contexts`. The request context container object contains a collection of context objects, which contain various settings that can influence the next invocation request. For more details about Artix contexts, see the contexts chapter from *Developing Artix Applications in C++*.
2. Obtain a pointer to the `BusSecurity` context object from the request context container. The `BusSecurity` context is selected by passing the QName constant, `IT_ContextAttributes::SECURITY_SERVER_CONTEXT`,



- as the first parameter to `get_context()`. The second parameter to `get_context()`, with the boolean value `true`, indicates that a new `BusSecurity` instance should be created, if one does not already exist.
3. Cast the return value from `get_context()` to the `IT_ContextAttributes::BusSecurity` type.
  4. Call the `setWSSEUsernameToken()` and `setWSSEPasswordToken()` functions to specify the credentials to send with the next invocation. In this example the username and password are sent in the SOAP header and formatted according to the WSS standard.
  5. Invoke the remote WSDL operation, `sayHi`. The specified username and password are propagated in the SOAP header along with this invocation request.

## Client configuration

[Example 112](#) shows the configuration of the SOAP client in this scenario, which uses the `secure_artix.secure_soap_corba.client.gssup` configuration scope.

### Example 112: SOAP Client Configuration

```
# Artix Configuration File
...
secure_artix
{
  secure_soap_corba
  {
    initial_references:IT_SecurityService:reference =
"corbaloc:it_iiops:1.2@localhost:58482/IT_SecurityService";

    client
    {
      # Secure HTTPS client-side configuration
      policies:https:trusted_ca_list_policy =
1 "C:\artix_30\artix\3.0\demos\security\certificates\tls\x509\t
   rusted_ca_lists/ca_list1.pem";
      policies:client_secure_invocation_policy:requires =
2 ["Confidentiality", "Integrity", "DetectReplay",
   "DetectMisordering", "EstablishTrustInTarget"];
      policies:client_secure_invocation_policy:supports =
["Confidentiality", "Integrity", "DetectReplay",
   "DetectMisordering", "EstablishTrustInClient",
   "EstablishTrustInTarget"];
    }
  }
}
```

**Example 112: SOAP Client Configuration**

```

3      principal_sponsor:use_principal_sponsor = "true";
      principal_sponsor:auth_method_id = "pkcs12_file";
      principal_sponsor:auth_method_data =
["filename=C:\artix_30\artix\3.0\demos\security\certificates\
openssl\x509\certs\testaspen.pl2", "password=testaspen"];
      ...
      gssup
4      {
          orb_plugins = ["xmlfile_log_stream", "https",
"artix_security"];
          binding:artix:client_request_interceptor_list =
"security+principal_context";
      };
};

```

The preceding client configuration can be explained as follows:

1. The trusted CA list policy specifies a listed of trusted CA certificates. During the SSL handshake, the client checks that the server's certificate is signed by one of the CA certificates from this list.
2. The client's HTTPS security policies require that connections are secure and the server identifies itself by sending an X.509 certificate.
3. Because this client supports mutual SSL authentication, the principal sponsor settings are used to associate an X.509 certificate with the client application.
4. There is no need to list all of the requisite plug-ins explicitly in the `orb_plugins` list. In particular, Artix loads the `at_http` plug-in and the `https` plug-in implicitly, because the client connects to a remote WSDL service that requires HTTPS (the SOAP address that appears in the WSDL contract starts with the `https://` prefix).

If you use a SOAP 1.2 binding, it is also necessary to include the `artix_security` plug-in and to configure the client request interceptor list as shown.

---

## SOAP-to-CORBA Router

---

### Overview

The SOAP-to-CORBA router receives incoming SOAP/HTTP requests, translates them into IIOP requests and then forwards them on to a CORBA server. In addition to translating requests, the router is also configured to transfer the incoming username/password credentials (embedded in a SOAP header) into outgoing CSI credentials (embedded in a GIOP service context). Hence, the SOAP-to-CORBA router enables interoperability of SOAP/HTTP security with CORBA security.

---

### Transferring credentials from SOAP to CORBA

The transfer of credentials from SOAP to CORBA obeys the following semantics:

- Extracting username/password credentials—the router can extract either WSS username/password from the SOAP header or username/password from the HTTP header. If username/password credentials are sent in both headers, you can influence the priority by setting the `plugins:asp:security_level` configuration variable to one of the following values:
  - ◆ `REQUEST_LEVEL`—give priority to the WSS username and password from the SOAP header.
  - ◆ `MESSAGE_LEVEL`—give priority to the username and password from the HTTP header.
- The username and password credentials are inserted into GSSUP credentials, which are transmitted using the CSI authentication over transport mechanism.
- The domain name in the GSSUP credentials is set to an empty string (which acts as a wildcard that matches any domain).
- The router does *not* attempt to authenticate the GSSUP credentials. Hence, the router does not call the Artix security service.
- The GSSUP credentials are used for a *single* invocation only.

**Note:** Internally, the GSSUP credentials are set using the `IT_CSI::CSICurrent3::set_effective_own_gssup_credentials_info()` function.

**Router WSDL contract**

**Example 113** shows the WSDL contract for the SOAP-to-CORBA router.

**Example 113: SOAP-to-CORBA Router WSDL Contract**

```

<?xml version="1.0" encoding="UTF-8"?>
<definitions name="HelloWorldService"
  targetNamespace="http://xmlbus.com/HelloWorld"
  xmlns="http://schemas.xmlsoap.org/wsdl/"
  xmlns:corba="http://schemas.ionas.com/bindings/corba"
  ...
  xmlns:soap="http://schemas.xmlsoap.org/wsdl/soap/"
  ...>
  <types>
    ...
  </types>
  ...
  <portType name="HelloWorldPortType">
    ...
  </portType>

  <binding name="HelloWorldPortBinding"
    type="tns:HelloWorldPortType">
    ...
  </binding>

  <binding name="CORBAHelloWorldBinding"
    type="tns:HelloWorldPortType">
    ...
  </binding>

1  <service name="HelloWorldService">
    <port binding="tns:HelloWorldPortBinding"
      name="HelloWorldPort">
2    <soap:address location="https://localhost:8085"/>
    </port>
  </service>

3  <service name="CORBAHelloWorldService">
    <port binding="tns:CORBAHelloWorldBinding"
      name="CORBAHelloWorldPort">
4    <corba:address
      location="file:../../corba/server/HelloWorld.ior"/>
    <corba:policy/>
    </port>
  </service>

```

**Example 113:** SOAP-to-CORBA Router WSDL Contract

```

5 <ns2:route name="r1">
    <ns2:source      port="HelloWorldPort"
                    service="tns:HelloWorldService"/>
    <ns2:destination port="CORBAHelloWorldPort"
                    service="tns:CORBAHelloWorldService"/>
  </ns2:route>
</definitions>

```

The preceding router WSDL contract can be explained as follows:

1. The `HelloWorldService` specifies a SOAP/HTTP endpoint for the `HelloWorldPortType` port type.
2. The SOAP/HTTP endpoint has the address, `https://localhost:8085` (you might want to change this to specify the actual name of the host where the router is running).

**Note:** The secure HTTPS protocol is used here (as indicated by the `https` prefix in the URL).

3. The `CORBAHelloWorldService` specifies a CORBA endpoint for the `HelloWorldPortType` port type.
4. The location of the CORBA endpoint is given by a stringified interoperable object reference (IOR), which is stored in the file, `HelloWorld.ior`. The CORBA server is programmed to create this file as it starts up.

**Note:** A more sophisticated alternative for specifying the CORBA endpoint would be to use the CORBA Naming Service.

5. The `route` element sets up a route as follows:
  - ◆ The source endpoint (which receives incoming requests) is the SOAP/HTTP endpoint, `HelloWorldPort`.
  - ◆ The destination endpoint (to which the router sends outgoing requests) is the CORBA endpoint, `CORBAHelloWorldPort`.

**Router configuration**

[Example 114](#) shows the configuration of the router in this scenario, which uses the `secure_artix.secure_soap_corba.switch.gssup` configuration scope.

**Example 114: SOAP-to-CORBA Router Configuration**

```
# Artix Configuration File
...
secure_artix
{
  secure_soap_corba
  {
    initial_references:IT_SecurityService:reference =
"corbaloc:it_iops:1.2@localhost:58482/IT_SecurityService";

    switch
    {
      #####
      # required for token propagation

      # iiop_tls config
1 policies:iiop_tls:trusted_ca_list_policy =
  "C:\artix_30\artix\3.0\demos\security\certificates\tls\x509\t
  rusted_ca_lists/ca_list1.pem";
2 policies:iiop_tls:client_secure_invocation_policy:requires =
  ["Integrity", "Confidentiality", "DetectReplay",
  "DetectMisordering"];
policies:iiop_tls:client_secure_invocation_policy:supports =
  ["Integrity", "Confidentiality", "DetectReplay",
  "DetectMisordering", "EstablishTrustInClient",
  "EstablishTrustInTarget"];
3   principal_sponsor:use_principal_sponsor = "true";
   principal_sponsor:auth_method_id = "pkcs12_file";
   principal_sponsor:auth_method_data =
  ["filename=router_cert.p12","password_file=router_cert.pwf"];

   # csi auth config
4   policies:csi:auth_over_transport:client_supports =
  ["EstablishTrustInClient"];
   policies:csi:attribute_service:client_supports =
  ["IdentityAssertion"];

   #binding/plugin list
5   orb_plugins = ["xmlfile_log_stream", "iiop_profile",
  "giop", "iiop_tls", "routing", "gsp", "artix_security"];

```

**Example 114: SOAP-to-CORBA Router Configuration**

```

binding:artix:server_request_interceptor_list =
"principal_context+security";
policies:asp:enable_security = "false";
policies:asp:enable_authorization = "false";

6      plugins:routing:wSDL_url="../../etc/router.wSDL";

      # Secure HTTPS server-side settings
      policies:https:trusted_ca_list_policy =
"C:\artix_30\artix\3.0\demos\security\certificates\openssl\x5
09\ca\cacert.pem";
      policies:target_secure_invocation_policy:requires =
["Confidentiality", "Integrity", "DetectReplay",
"DetectMisordering", "EstablishTrustInClient"];
      policies:target_secure_invocation_policy:supports =
["Confidentiality", "Integrity", "DetectReplay",
"DetectMisordering", "EstablishTrustInClient",
"EstablishTrustInTarget"];

      gssup
      {
          #####
          # flags to control credential propagation
          policies:bindings:corba:token_propagation="false";
          policies:bindings:corba:gssup_propagation="true";
          #####
      };
  };
};
};

```

The preceding router configuration can be explained as follows:

1. This trusted CA list policy specifies the CA certificates that are used to check certificates received from the CORBA server during the SSL/TLS handshake.
2. This policy specifies that the router can only open secure IIOP/TLS connections to CORBA servers.
3. The principal sponsor settings associate an X.509 certificate with the Artix router.
4. CSI provides two different mechanisms for transporting credentials, both of which are supported by the router:

- ◆ *Authorization over transport*—transfers credentials in the form of a username, password and domain name. This is the mechanism used in the current scenario.
  - ◆ *Identity assertion*—transfers credentials in the form of an asserted identity. This is the mechanism that is used in combination with single sign-on—see [“Single Sign-On SOAP-to-CORBA Scenario” on page 516](#).
5. The `iiop_tls` plug-in enables secure IIOP/TLS communication. The `at_http` plug-in and the `https` plug-in are loaded implicitly, because they are required by the `HelloWorldService` service in the WSDL contract.  
If you use a SOAP 1.2 binding, you must include the `artix_security` plug-in, as shown. In this case, you must also initialize the server request interceptor list and disable authentication and authorization, as shown in the following lines. The Artix security plug-in is needed only for the purpose of extracting security credentials from the SOAP 1.2 headers. The authentication and authorization features are not needed here.
  6. This line specifies the location of the router WSDL contract.
  7. The token propagation option is disabled in this scenario.
  8. The GSSUP propagation option is enabled in this scenario. This is the key setting for enabling security interoperability. The CORBA binding extracts the username and password credentials from incoming SOAP/HTTP invocations and inserts them into an outgoing GSSUP credentials object, to be transmitted using CSI authentication over transport. The domain name in the outgoing GSSUP credentials is set to a blank string.



## CORBA Server

### Overview

In this scenario, the CORBA server must be configured to accept GSSUP credentials through the CSI authentication over transport mechanism. This subsection describes how to configure the CORBA server to authenticate the received CSI credentials.

### Server configuration

**Example 115** shows the configuration of the CORBA server in this scenario, which uses the `secure_artix.secure_soap_corba.server.gssup` configuration scope.

#### **Example 115:** *CORBA Server Supporting GSSUP Credentials*

```
secure_artix
{
  secure_soap_corba
  {
    initial_references:IT_SecurityService:reference =
"corbaloc:it_iops:1.2@localhost:58482/IT_SecurityService";

    server
    {
      # binding/plugin list
      orb_plugins = ["local_log_stream", "iiop_profile",
"giop", "iiop_tls", "gsp"];
      binding:server_binding_list = ["CSI+GSP", "CSI", "GSP"];

      # disable authorization
1      plugins:gsp:enable_authorization="false";
2      # disable client side caching
      # plugins:gsp:authentication_cache_size = "-1";
      # plugins:gsp:authentication_cache_timeout = "0";

      # csi auth config
3      policies:csi:auth_over_transport:server_domain_name =
"PCGROUP";
      policies:csi:attribute_service:target_supports =
["IdentityAssertion"];
```

**Example 115: CORBA Server Supporting GSSUP Credentials**

```

# iiop_tls config
policies:iiop_tls:trusted_ca_list_policy =
  "C:\artix_30\artix\3.0\demos\security\certificates\tls\x509\t
  rusted_ca_lists/ca_list1.pem";
4 policies:iiop_tls:target_secure_invocation_policy:supports =
  ["Integrity", "Confidentiality", "DetectReplay",
  "DetectMisordering", "EstablishTrustInTarget",
  "EstablishTrustInClient"];
policies:iiop_tls:target_secure_invocation_policy:requires =
  ["Integrity", "Confidentiality", "DetectReplay",
  "DetectMisordering", "EstablishTrustInClient"];
5     principal_sponsor:use_principal_sponsor = "true";
     principal_sponsor:auth_method_id = "pkcs12_file";
     principal_sponsor:auth_method_data =
  ["filename=server_cert.p12", "password_file=server_cert.pwf"];

# Configuration required for Token propagation.
6     plugins:gsp:accept_asserted_authorization_info =
  "false";

# Configuration required for GSSUP propagation.
7     policies:csi:auth_over_transport:target_requires =
  ["EstablishTrustInClient"];
     policies:csi:auth_over_transport:target_supports =
  ["EstablishTrustInClient"];
  };
};
};

```

The preceding server configuration can be described as follows:

1. In this example, authorization is disabled for simplicity. You can enable authorization, however, if your application requires it.
2. You might want to disable client side caching for testing purposes (this would force the server to contact the security service with every invocation). Normally, however, you should leave these lines commented out, as shown here. Client caching improves performance considerably.
3. If needed for authorization purposes, you can set the domain name here.

4. These settings for the IIOP/TLS target secure invocation policy ensure that the server accepts only secure connections. The server also requires the `EstablishTrustInClient` association option, which implies that clients must provide an X.509 certificate during the SSL/TLS handshake.
5. The principal sponsor settings associate an X.509 certificate (in PKCS#12 format) with the CORBA server.
6. If the server receives credentials in the form of an SSO token, this setting ensures that the server re-authenticates the token, instead of relying on SAML data propagated with the request.
7. These CSI authorization over transport policies require clients to provide GSSUP credentials, which contain a username, password and domain name. The `gsp` plug-in is then responsible for contacting the Artix security service to authenticate these credentials.

---

# Single Sign-On SOAP-to-CORBA Scenario

---

## Overview

This section describes how to integrate a single sign-on SOAP client with a secure CORBA server, by interposing a suitably configured SOAP-to-CORBA Artix router.

---

## In this section

This section contains the following subsections:

<a href="#">Overview of the Secure SSO SOAP-to-CORBA Scenario</a>	<a href="#">page 517</a>
<a href="#">SSO SOAP Client</a>	<a href="#">page 519</a>
<a href="#">SSO SOAP-to-CORBA Router</a>	<a href="#">page 521</a>

# Overview of the Secure SSO SOAP-to-CORBA Scenario

## Overview

This subsection describes a variation of the secure SOAP-to-CORBA scenario, where the client is configured to use *single sign-on* (SSO). In this scenario, the client authenticates the username and password with the login service prior to sending an invocation to the router. Instead of sending username and password credentials to the router, the client sends the SSO token it received from the login service. The router can then be configured to propagate the SSO token to the remote CORBA server.

## SSO SOAP-to-CORBA scenario

Figure 51 shows the outline of a scenario where an SSO token, embedded in a SOAP header, is transformed into a CSI identity token, embedded in a GIOP header (GIOP service context).

Figure 51: Propagating an SSO Token Across a SOAP-to-CORBA Router

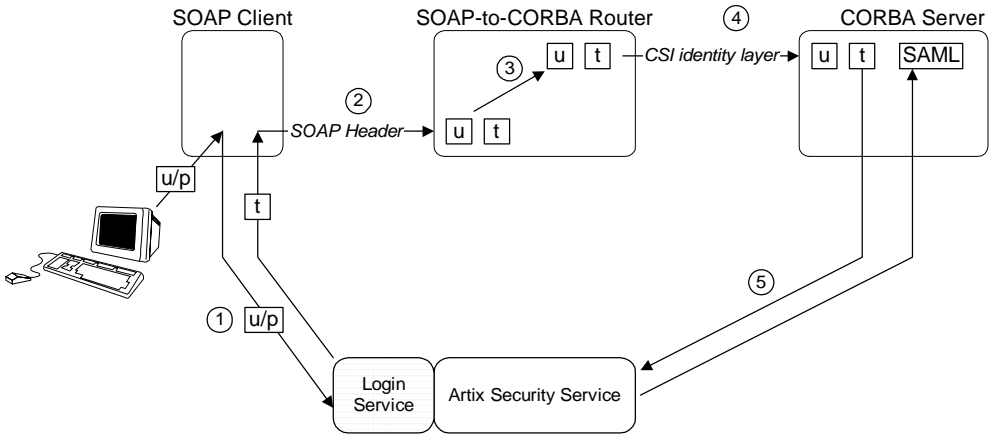

**Steps**

The steps for propagating credentials across the SOAP-to-CORBA router, as shown in [Figure 50](#), can be described as follows:

Stage	Description
1	When single sign-on is enabled, the client calls out to the login service, passing in the client's WSS credentials, $u/p$ , in order to obtain an SSO token.
2	When the client invokes an operation on the router, the SSO token, $t$ , is sent as the password in the WSS credentials.
3	The router extracts the username, $u$ , and the SSO token, $t$ , from the received WSS credentials and then inserts the username into the outgoing CSI identity token. <b>Note:</b> The router should <i>not</i> attempt to authenticate the received SSO token. In the current example, authentication does not occur, because the router does not load the <code>artix_security</code> plug-in.
4	The username, $u$ , is sent on to the CORBA server using the CSI identity assertion mechanism. The SSO token, $t$ , is transmitted to the CORBA server in a proprietary GIOP service context.
5	The CORBA server re-authenticates the client's SSO token, $t$ , by calling out to the Artix security service. The return value contains the SAML role and realm data for the token.

**Demonstration code**

Demonstration code for the SSO SOAP-to-CORBA scenario is available from the following location:

```
ArtixInstallDir/cxx_java/samples/security/secure_soap_corba
```

**Enabling token propagation**

To enable SSO token propagation (where received SSO tokens are inserted into the outgoing CSI identity token by the router), set the following router configuration variable to `true`:

```
policies:bindings:corba:token_propagation = "true";
```

---

## SSO SOAP Client

---

### Overview

This subsection describes how to configure a SOAP client to use single sign-on. The initial client credentials are a WSS username and password (programmed as shown in [“Setting the WSS username and password” on page 503](#)). After contacting the login service, however, the client uses an SSO token as its credentials for subsequent invocations.

### SSO client configuration

[Example 116](#) shows the configuration of the single sign-on SOAP client, which uses the `secure_artix.secure_soap_corba.client.token` configuration scope.

#### **Example 116:** *Single Sign-On SOAP Client Configuration*

```
# Artix Configuration File
...
secure_artix
{
  secure_soap_corba
  {
    initial_references:IT_SecurityService:reference =
    "corbaloc:it_iiops:1.2@localhost:58482/IT_SecurityService";

    client
    {
      # Secure HTTPS client-side configuration
      policies:https:trusted_ca_list_policy =
      "C:\artix_30\artix\3.0\demos\security\certificates\tls\x509\t
      rusted_ca_lists\ca_list1.pem";
      policies:client_secure_invocation_policy:requires =
      ["Confidentiality", "Integrity", "DetectReplay",
      "DetectMisordering", "EstablishTrustInTarget"];
      policies:client_secure_invocation_policy:supports =
      ["Confidentiality", "Integrity", "DetectReplay",
      "DetectMisordering", "EstablishTrustInClient",
      "EstablishTrustInTarget"];

      principal_sponsor:use_principal_sponsor = "true";
      principal_sponsor:auth_method_id = "pkcs12_file";
      principal_sponsor:auth_method_data =
      ["filename=C:\artix_30\artix\3.0\demos\security\certificates\
      openssl\x509\certs\testaspen.p12", "password=testaspen"];
    }
  }
}
```

**Example 116: Single Sign-On SOAP Client Configuration**

```

...
token
{
1   orb_plugins = ["xmlfile_log_stream",
"login_client", "https", "artix_security"];
2   binding:artix:client_request_interceptor_list=
"login_client+security+principal_context";
3   bus:initial_contract:url:login_service =
"../../wsdl/login_service.wsdl";
   };
};
};

```

The preceding configuration can be explained as follows:

1. To enable the single sign-on functionality in the client, add the `login_client` plug-in to the list of ORB plug-ins.  
If the client uses a SOAP 1.2 binding, it is also necessary to include the `artix_security` plug-in in the `orb_plugins` list.
2. It is also necessary to add `login_client` to the Artix client request interceptor list (the single sign-on functionality is implemented by a client request interceptor).  
If the client uses a SOAP 1.2 binding, it is also necessary to include the `security` and `principal_context` interceptors in the order shown.
3. The `bus:initial_contract:url:login_service` variable specifies the location of the login service's WSDL contract. This contract contains the address of the login service endpoint.



---

## SSO SOAP-to-CORBA Router

---

### Overview

The single sign-on SOAP-to-CORBA router is configured similarly to the normal SOAP-to-CORBA router ([“SOAP-to-CORBA Router” on page 507](#)), except that the CORBA binding is configured to enable token propagation instead of GSSUP propagation.

---

### Transferring credentials from SOAP to CORBA

The transferal of credentials from SOAP to CORBA in the single sign-on scenario obeys the following semantics:

- The SSO token credentials are inserted into a proprietary GIOP service context, which is transmitted in the header of the outgoing IIOP/TLS message.
  - The router does *not* attempt to authenticate the SSO token. Hence, the router does not call the Artix security service.
  - The SSO token is used for a *single* invocation only.
- 

### SSO router configuration

[Example 117](#) shows the configuration of the single sign-on router, which uses the `secure_artix.secure_soap_corba.switch.token` configuration scope.

#### Example 117: Single Sign-On SOAP-to-CORBA Router Configuration

```
# Artix Configuration File
secure_artix
{
  secure_soap_corba
  {
    initial_references:IT_SecurityService:reference =
      "corbaloc:it_iiops:1.2@localhost:58482/IT_SecurityService";

    switch
    {
1      # Common configuration
      ...
2      policies:csi:attribute_service:client_supports =
        ["IdentityAssertion"];
      ...
    }
  }
}
```

**Example 117:** *Single Sign-On SOAP-to-CORBA Router Configuration*

```

3         token
4         {
            policies:bindings:corba:token_propagation="true";
            policies:bindings:corba:gssup_propagation="false";
        };
        ...
    };
};
};

```

The preceding router configuration can be explained as follows:

1. The rest of the `secure_artix.secure_soap_corba.switch` scope is the same as the scenario without single sign-on. See [“SOAP-to-CORBA Router” on page 507](#) for details.
2. This line is of particular importance for the single sign-on scenario. It enables the CSI identity assertion mechanism, which is needed to transmit the SSO token to the CORBA server.
3. The token propagation option is enabled in this scenario. This is the key setting for enabling security interoperability. The CORBA binding extracts the SSO token from incoming SOAP/HTTP invocations and inserts the token into an outgoing IIOP request, to be transmitted using CSI identity assertion.
4. The GSSUP propagation option is disabled in this scenario.

---

# CORBA-to-SOAP Scenario

---

**Overview**

This section describes how to integrate a secure CORBA client with a secure SOAP server, by interposing a suitably configured CORBA-to-SOAP Artix router. The router transforms the CORBA client's CSI/GSSUP credentials (consisting of username, password, and domain) into WSS credentials (consisting of username and password) for the SOAP server.

---

**In this section**

This section contains the following subsections:

<a href="#">Overview of the Secure CORBA-to-SOAP Scenario</a>	<a href="#">page 524</a>
<a href="#">CORBA Client</a>	<a href="#">page 526</a>
<a href="#">CORBA-to-SOAP Router</a>	<a href="#">page 528</a>
<a href="#">SOAP Server</a>	<a href="#">page 534</a>

## Overview of the Secure CORBA-to-SOAP Scenario

### Overview

This subsection describes a secure CORBA-to-SOAP scenario, where the router is configured to integrate CORBA security with SOAP security. The key functionality provided by the router in this scenario is the ability to extract CORBA CSI credentials (provided in the form of a GSSUP username, password, and domain) and propagate them as SOAP-compatible WSS credentials.

### SOAP-to-CORBA scenario

Figure 52 shows the outline of a scenario where GSSUP credentials, embedded in a GIOP service context, are transformed into WSS username and password credentials, embedded in a SOAP header.

**Figure 52:** *Propagating Credentials Across a CORBA-to-SOAP Router*

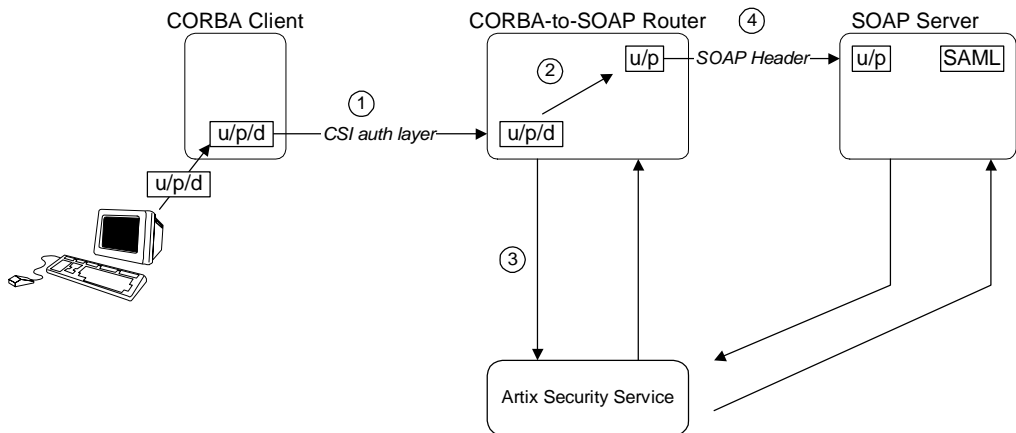

**Steps**

The steps for propagating credentials across the CORBA-to-SOAP router, as shown in [Figure 52](#), can be described, as follows:

Stage	Description
1	The client initializes the GSSUP username, password, and domain credentials, <i>u/p/d</i> , and sends these credentials, embedded in a GIOP service context, across to the router.
2	The router extracts the received GSSUP username, password, and domain credentials, <i>u/p/d</i> , and transfers them into WSS credentials, consisting of a username and a password. The domain name is discarded.
3	The WSS credentials, <i>u/p</i> , are sent on to the SOAP server inside a WSS SOAP header.
4	The SOAP server authenticates the received WSS credentials, <i>u/p</i> , by calling out to the Artix security service (this step is performed automatically by the <code>artix_security</code> plug-in).

**Demonstration code**

Demonstration code for this CORBA-to-SOAP scenario is available from the following location:

```
ArtixInstallDir/cxx_java/samples/security/secure_corba_soap
```

**Enabling WSS propagation**

To enable WSS propagation (where received username and password credentials are inserted into the outgoing GSSUP credentials by the router), set the following router configuration variable to `true`:

```
policies:bindings:soap:gssup_propagation = "true";
```

**Enabling token propagation**

Additionally, you can enable Artix security token propagation by setting the following router configuration variable to `true`:

```
policies:bindings:soap:token_propagation = "true";
```

## CORBA Client

### Overview

This section describes how to configure a CORBA client to send username and password credentials through the CSI authentication over transport mechanism (which puts the user's credentials into a GIOP service context). When a client request arrives in the router, the propagation mechanism in the router extracts the username and password from the incoming CSI credentials.

### Client configuration

[Example 118](#) shows the configuration of the SOAP client in this scenario, which uses the `secure_artix.secure_corba_soap.client` configuration scope.

#### Example 118: SOAP Client Configuration

```
# Artix Configuration File
...
secure_artix
{
  secure_soap_corba
  {
    client
    {
      # iiop_tls config
      1 policies:iiop_tls:client_secure_invocation_policy:requires
      = ["Integrity", "Confidentiality", "DetectReplay",
      "DetectMisordering"];

      # csi auth config
      2 policies:csi:auth_over_transport:authentication_service
      = "com.iona.corba.security.csi.AuthenticationService";
      policies:csi:auth_over_transport:client_supports =
      ["EstablishTrustInClient"];
      policies:csi:attribute_service:client_supports =
      ["IdentityAssertion"];

      #binding/plugin list
      3 orb_plugins = ["xmlfile_log_stream", "iiop_profile",
      "giop", "iiop_tls", "csi"];

      4 principal_sponsor:use_principal_sponsor = "true";
      principal_sponsor:auth_method_id = "pkcs12_file";
    }
  }
}
```

**Example 118: SOAP Client Configuration**

```

principal_sponsor:auth_method_data =
["filename=C:\artix_40\artix\4.0\demos\security\certificates/
tls/x509/certs/services/administrator.p12",
"password_file=C:\artix_40\artix\4.0\demos\security\certifica
tes/tls/x509/certs/services/administrator.pwf"];

5      principal_sponsor:csi:use_principal_sponsor = "true";
      principal_sponsor:csi:auth_method_id = "GSSUPMech";
      principal_sponsor:csi:auth_method_data =
["username=user_test", "password=user_password",
"domain=PCGROUP"];
      };
};
};

```

The preceding client configuration can be explained as follows:

1. The IOP/TLS client invocation policies specified here ensure that the outgoing client connections are secure.
2. The following three lines specify the basic CSI configuration on the client side, enabling both CSI authentication over transport and CSI identity assertion.
3. To enable the client to send credentials using the CSI mechanisms, the `orb_plugins` list includes the `csi` plug-in. Alternatively, you can also enable CSI by loading the `gsp` plug-in (which implicitly loads the `csi` plug-in).
4. The principal sponsor settings on the following lines associate the client's own X.509 certificate with the SSL/TLS layer.
5. The CSI principal sponsor settings on the following lines are used to specify the CSI credentials in the form of a username, a password and a domain name.

---

## CORBA-to-SOAP Router

---

### Overview

The CORBA-to-SOAP router receives incoming IIOP requests, translates them into SOAP/HTTP requests and then forwards them on to a SOAP server. In addition to translating requests, the router is also configured to transfer the incoming CSI credentials (embedded in a GIOP message context) into outgoing WSS credentials (embedded in a SOAP header). Hence, the CORBA-to-SOAP router enables interoperation of CORBA security with SOAP/HTTP security.

---

### Transferring credentials from CORBA to SOAP

The transferal of credentials from CORBA to SOAP obeys the following semantics:

- The router authenticates the incoming CSI credentials, obtaining a security token from the Artix security service.
  - The router embeds the security token in the outgoing SOAP header.
  - The username from the incoming CSI credentials is embedded in the outgoing SOAP header (in the WSS credentials).
  - The domain name from the incoming CSI credentials is discarded (the WSS credentials do not include a domain name).
- 

### Router WSDL contract

[Example 119](#) shows the WSDL contract for the CORBA-to-SOAP router.

#### **Example 119:** *CORBA-to-SOAP Router WSDL Contract*

```
<?xml version="1.0" encoding="UTF-8"?>
<definitions name="HelloWorldService"
  targetNamespace="http://xmlbus.com/HelloWorld"
  xmlns="http://schemas.xmlsoap.org/wsdl/"
  xmlns:corba="http://schemas.ionas.com/bindings/corba"
  ...
  xmlns:soap="http://schemas.xmlsoap.org/wsdl/soap/"
  ...>
  <types>
    ...
  </types>
  ...
  <portType name="HelloWorldPortType">
    ...
```



**Example 119:** CORBA-to-SOAP Router WSDL Contract

```

</portType>

<binding name="HelloWorldPortBinding"
         type="tns:HelloWorldPortType">
  ...
</binding>

<binding name="CORBAHelloWorldBinding"
         type="tns:HelloWorldPortType">
  ...
</binding>

1 <service name="HelloWorldService">
  <port binding="tns:HelloWorldPortBinding"
        name="HelloWorldPort">
2     <soap:address location="https://localhost:8085"/>
  </port>
</service>

3 <service name="CORBAHelloWorldService">
  <port binding="tns:CORBAHelloWorldBinding"
        name="CORBAHelloWorldPort">
4     <corba:address
        location="file:../../corba/server/HelloWorld.ior"/>
        <corba:policy/>
  </port>
</service>

5 <ns2:route name="r1">
  <ns2:source port="CORBAHelloWorldPort"
             service="tns:CORBAHelloWorldService"/>
  <ns2:destination port="HelloWorldPort"
                  service="tns:HelloWorldService"/>
</ns2:route>
</definitions>

```

The preceding router WSDL contract can be explained as follows:

1. The `HelloWorldService` specifies a SOAP/HTTP endpoint for the `HelloWorldPortType` port type.
2. The SOAP/HTTP endpoint has the address, `https://localhost:8085` (you might want to change this to specify the actual name of the host where the SOAP server is running).

**Note:** The secure HTTPS protocol is used here (as indicated by the `https` prefix in the URL).

3. The `CORBAHelloWorldService` specifies a CORBA endpoint for the `HelloWorldPortType` port type.
4. The location of the CORBA endpoint is given by a stringified interoperable object reference (IOR). The router automatically opens an IP listener port and writes the corresponding IOR into the `HelloWorld.ior` file.

**Note:** A more sophisticated alternative for publishing the CORBA endpoint would be to use the CORBA Naming Service.

5. The `route` element sets up a route as follows:
  - ◆ The source endpoint (which receives incoming requests) is the CORBA endpoint, `CORBAHelloWorldPort`.
  - ◆ The destination endpoint (to which the router sends outgoing requests) is the SOAP/HTTP endpoint, `HelloWorldPort`.

## Router configuration

[Example 120](#) shows the configuration of the router in this scenario, which uses the `secure_artix.secure_corba_soap.switch` configuration scope.

### Example 120: CORBA-to-SOAP Router Configuration

```
# Artix Configuration File
...
secure_artix
{
  secure_soap_corba
  {
    initial_references:IT_SecurityService:reference =
"corbaloc:it_iops:1.2@localhost:58482/IT_SecurityService";
```

**Example 120: CORBA-to-SOAP Router Configuration**

```

switch
{
  # disable authorization
1      plugins:gsp:enable_authorization="false";

  # iiop_tls config
2
  policies:iiop_tls:client_secure_invocation_policy:requires =
  ["Integrity", "Confidentiality", "DetectReplay",
  "DetectMisordering"];

  policies:iiop_tls:target_secure_invocation_policy:requires =
  ["Integrity", "Confidentiality", "DetectReplay",
  "DetectMisordering"];

3      principal_sponsor:use_principal_sponsor = "true";
      principal_sponsor:auth_method_id = "pkcs12_file";
      principal_sponsor:auth_method_data =
  ["filename=C:\artix_40/artix/4.0/demos/security/certificates/
  tls/x509/certs/services/administrator.pl2",
  "password_file=C:\artix_40/artix/4.0/demos/security/certifica
  tes/tls/x509/certs/services/administrator.pwf"];

  # csi auth config
4      policies:csi:attribute_service:target_supports =
  ["IdentityAssertion"];
      policies:csi:auth_over_transport:target_requires =
  ["EstablishTrustInClient"];
      policies:csi:auth_over_transport:target_supports =
  ["EstablishTrustInClient"];

  #binding/plugin list
5      orb_plugins = ["xmlfile_log_stream", "iiop_profile",
  "giop", "iiop_tls", "routing", "gsp", "artix_security"];
      binding:artix:client_request_interceptor_list =
  "security+principal_context";
      policies:asp:enable_security = "false";
      policies:asp:enable_authorization = "false";
      binding:server_binding_list = ["CSI+GSP", "CSI",
  "GSP"];

6      plugins:routing:wSDL_url="../etc/router.wSDL";

      plugins:xmlfile_log_stream:use_pid = "true";

```

**Example 120: CORBA-to-SOAP Router Configuration**

```

7         # secure HTTPS client -> secure HTTPS server settings
          plugins:at_http:client:use_secure_sockets="true";
          plugins:at_http:client:trusted_root_certificates =
"C:\artix_40\artix\4.0\demos\security\certificates\openssl\x5
09/ca/cacert.pem";
          plugins:at_http:client:client_certificate =
"C:\artix_40\artix\4.0\demos\security\certificates\openssl\x5
09/certs/testaspen.p12";
          plugins:at_http:client:client_private_key_password =
"testaspen";

8         policies:bindings:soap:token_propagation = "true";
          policies:bindings:soap:gssup_propagation = "true";
        };
    };
};

```

The preceding router configuration can be explained as follows:

1. There is no need for the router to perform authorization on incoming CORBA messages. Therefore, it makes sense to disable authorization in the GSP plug-in (which is responsible for the authentication and authorization of CORBA messages).
2. The IIOPTLS client and target invocation policies specified here ensure that both outgoing and incoming IIOPTLS connections are secure.
3. The principal sponsor settings associate an X.509 certificate with the Artix router.
4. The following three lines specify the basic CSI configuration on the client side, enabling both CSI authentication over transport and CSI identity assertion.
5. The `gsp` plug-in must be included in the `orb_plugins` list to enable the router to parse incoming CSI credentials and to authenticate the CSI credentials with the Artix security service.

If you use a SOAP 1.2 binding, you must include the `artix_security` plug-in, as shown. In this case, you must also initialize the client request interceptor list and disable authentication and authorization, as shown in the following lines. The Artix security plug-in is needed only

for the purpose of inserting security credentials into SOAP 1.2 headers. The authentication and authorization features are not needed here.

6. This line specifies the location of the router WSDL contract.
7. The following four lines configure security for the HTTPS transport. In particular, the `plugins:at_http:client:client_certificate` configuration variable specifies an own X.509 certificate to use specifically with the HTTPS transport.
8. The CORBA-to-SOAP GSSUP propagation option is enabled in this scenario.

This is the key setting for enabling security interoperability. The router extracts the username, password, and domain credentials from incoming CORBA invocations and inserts them into an outgoing WSS credentials object, to be transmitted in a WSS SOAP header. The domain name from the incoming CORBA message gets discarded.

## SOAP Server

### Overview

In this scenario, the SOAP server must be configured to accept WSS credentials, which are transmitted in a SOAP header. This subsection describes how to configure the SOAP server to authenticate the received WSS credentials.

### Server configuration

**Example 121** shows the configuration of the SOAP server in this scenario, which uses the `secure_artix.secure_corba_soap.server` configuration scope.

#### **Example 121:** SOAP Server Supporting WSS Credentials

```
secure_artix
{
  secure_corba_soap
  {
    initial_references:IT_SecurityService:reference =
"corbaloc:it_iops:1.2@localhost:58482/IT_SecurityService";

    server
    {
1      principal_sponsor:use_principal_sponsor = "true";
      principal_sponsor:auth_method_id = "pkcs12_file";
      principal_sponsor:auth_method_data =
["filename=C:\artix_40\artix\4.0\demos\security\certificates/
tls/x509/certs/services/administrator.p12",
"password_file=C:\artix_40\artix\4.0\demos\security\certifica
tes/tls/x509/certs/services/administrator.pwf"];

2      policies:target_secure_invocation_policy:requires =
["Confidentiality", "Integrity", "DetectReplay",
"DetectMisordering"];
      policies:target_secure_invocation_policy:supports =
["Confidentiality", "Integrity", "DetectReplay",
"DetectMisordering", "EstablishTrustInClient",
"EstablishTrustInTarget"];

      binding:artix:server_request_interceptor_list=
"principal_context+security";
3      orb_plugins = ["xmlfile_log_stream", "iiop_profile",
"giop", "iiop_tls", "artix_security"];
    }
  }
}
```

**Example 121: SOAP Server Supporting WSS Credentials**

```

4     policies:asp:enable_authorization = "false";
5     plugins:asp:security_level = "REQUEST_LEVEL";
6
    plugins:at_http:server:trusted_root_certificates =
"C:\artix_40\artix\4.0\demos\security\certificates\openssl\x5
09/ca/cacert.pem";
    plugins:at_http:server:server_certificate =
"C:\artix_40\artix\4.0\demos\security\certificates\openssl\x5
09/certs/testaspen.p12";
    plugins:at_http:server:server_private_key_password =
"testaspen";
    };
};
};

```

The preceding server configuration can be described as follows:

1. The principal sponsor settings associate an X.509 certificate with the SOAP server. This certificate is used when opening a connection to the Artix security service (this connection uses the IIOP/TLS protocol).
2. The target invocation policies specified here ensure that incoming connections are secure, for both the IIOP/TLS and HTTPS protocols.
3. You must include the `artix_security` plug-in in the `orb_plugins` list to enable Artix security. The `iiop_tls` plug-in is required in order to communicate with the Artix security service. In addition, the `at_http` plug-in and the `https` plug-in are loaded, but there is no need to include `at_http` or `https` in the `orb_plugins` list. Because the HTTPS port is specified in the WSDL contract, Artix implicitly loads the `at_http` and `https` plug-ins.
4. In this example, authorization is disabled. In most deployed systems, however, you would probably need to enable authorization (and add the additional configuration settings—see [“Security Layer” on page 62](#)).
5. By setting the security level to `REQUEST_LEVEL`, you indicate that the credentials to authenticate are taken preferentially from the SOAP header (for example, the WSS credentials).

6. These settings specify an own X.509 certificate that is used with the HTTPS protocol only.



# Part V

## Programming Security

---

### In this part

This part contains the following chapters:

<a href="#">Programming Authentication—C++ Runtime</a>	<a href="#">page 539</a>
<a href="#">Programming Authentication—Java Runtime</a>	<a href="#">page 557</a>
<a href="#">Developing an iSF Adapter</a>	<a href="#">page 579</a>



# Programming Authentication— C++ Runtime

*To ensure that Web services and Web service clients developed using Artix can interoperate with the widest possible array of Web services, Artix supports the WS Security specification for propagating Kerberos security tokens, username/password security tokens and X.509 certificates in SOAP message headers. The security tokens are placed into the SOAP message header using Artix APIs that format the tokens and place them in the header correctly.*

---

**In this chapter**

This chapter discusses the following topics:

<a href="#">Configuration for SOAP 1.2 Bindings</a>	<a href="#">page 540</a>
<a href="#">Propagating a Username/Password Token</a>	<a href="#">page 541</a>
<a href="#">Propagating a Kerberos Token</a>	<a href="#">page 546</a>
<a href="#">Propagating an X.509 Certificate</a>	<a href="#">page 551</a>

---

# Configuration for SOAP 1.2 Bindings

## Overview

If you use a SOAP 1.2 binding to transmit the WSS Username/Password token, you need to ensure that the `artix_security` plug-in is loaded and configured both on the client side and on the server side.

## Client-side configuration for SOAP 1.2

On the client side, configure the `artix_security` plug-in as follows:

```
# Artix Configuration File
orb_plugins = ["xmlfile_log_stream", "artix_security", ...];

binding:artix:client_request_interceptor_list =
    "security+principal_context";
```

The client-side configuration is not required for SOAP 1.1 bindings.

## Server-side configuration for SOAP 1.2

On the server side, configure the `artix_security` plug-in as follows:

```
# Artix Configuration File
orb_plugins = ["xmlfile_log_stream", "artix_security", ...];

binding:artix:server_request_interceptor_list =
    "principal_context+security";
```

---

# Propagating a Username/Password Token

---

## Overview

Many Web services use simple username/password authentication to ensure that only preapproved clients can access them. Artix provides a simple client side API for embedding the username and password into the SOAP message header of requests in a WS Security compliant manner.

## C++ Procedure

Embedding a username and password token into the SOAP header of a request in Artix C++ requires you to do the following:

1. If you use a SOAP 1.2 binding, make sure to load and configure the `artix_security` plug-in as described in [“Configuration for SOAP 1.2 Bindings” on page 540](#).
2. Make sure that your application makefile is configured to link with the `it_context_attribute` library (`it_context_attribute.lib` on Windows and `it_context_attribute.so` or `it_context_attribute.a` on UNIX) which contains the `bus-security` context stub code.
3. Get a reference to the current `IT_ContextAttributes::BusSecurity` context data type, using the Artix context API (see *Developing Artix Applications in C++*).
4. Set the `WSSEUsernameToken` property on the `BusSecurity` context using the `setWSSEUsernameToken()` method.
5. Set the `WSSEPasswordToken` property on the `BusSecurity` context using the `setWSSEPasswordToken()` method.

## C++ Example

[Example 122](#) shows how to set the Web services username/password token in a C++ client prior to invoking a remote operation.

**Example 122:** *Setting a WS Username/Password Token in a C++ Client*

```
// C++
#include <it_bus/bus.h>
#include <it_bus/exception.h>
#include <it_cal/iostream.h>
```

**Example 122:** *Setting a WS Username/Password Token in a C++ Client*

```

// Include header files related to the bus-security context
#include <it_bus_pdk/context.h>
#include <it_bus_pdk/context_attrs/bus_security_xsdTypes.h>

IT_USING_NAMESPACE_STD

using namespace IT_ContextAttributes;
using namespace IT_Bus;

int
main(int argc, char* argv[])
{
    try
    {
        IT_Bus::Bus_var bus = IT_Bus::init(argc, argv);

        ContextRegistry* context_registry =
            bus->get_context_registry();

        // Obtain a reference to the ContextCurrent
        ContextCurrent& context_current =
            context_registry->get_current();

        // Obtain a pointer to the Request ContextContainer
        ContextContainer* context_container =
            context_current.request_contexts();

        // Obtain a reference to the context
1       AnyType* info = context_container->get_context(
            IT_ContextAttributes::SECURITY_SERVER_CONTEXT,
            true
        );

        // Cast the context into a BusSecurity object
2       BusSecurity* bus_security_ctx =
            dynamic_cast<BusSecurity*>(info);

        // Set the WS Username and Password tokens
3       bus_security_ctx->setWSSEUsernameToken("artix_user");
        bus_security_ctx->setWSSEPasswordToken("artix");
        ...
    }
    catch(IT_Bus::Exception& e)
    {
        cout << endl << "Error : Unexpected error occurred!"

```

**Example 122:** *Setting a WS Username/Password Token in a C++ Client*

```

        << endl << e.message()
        << endl;
        return -1;
    }
    return 0;
}

```

The preceding code can be explained as follows:

1. Call the `IT_Bus::ContextContainer::get_context()` function to obtain a pointer to a `BusSecurity` object. The first parameter is the `QName` of the `BusSecurity` context and the second parameter is set to `true`, indicating that a context with that `QName` will be created if none already exists.
2. Cast the `IT_Bus::AnyType` instance, `info`, to its derived type, `IT_ContextAttributes::BusSecurity`, which is the bus-security context data type.
3. Use the `BusSecurity` API to set the WSS username and password tokens. After this point, any SOAP operations invoked from the current thread will include the specified WSS username and password in the request message.

**Java Procedure**

Embedding a username and password token into the SOAP header of a request in Artix Java requires you to do the following:

1. If you use a SOAP 1.2 binding, make sure to load and configure the `artix_security` plug-in as described in [“Configuration for SOAP 1.2 Bindings” on page 540](#).
2. Create a new `com.iona.schemas.bus.security_context.BusSecurity` context data object.
3. Set the `WSSEUsernameToken` property on the `BusSecurity` context using the `setWSSEUsernameToken()` method.
4. Set the `WSSEPasswordToken` property on the `BusSecurity` context using the `setWSSEPasswordToken()` method.
5. Set the bus-security context for the outgoing request message by calling `setRequestContext()` on an `IonaMessageContext` object (see *Developing Artix Applications in Java*).

**Java Example**

**Example 123** shows how to set the Web services username/password token in a Java client prior to invoking a remote operation.

**Example 123: Setting a WS Username/Password Token in a Java Client**

```
// Java
import javax.xml.namespace.QName;
import javax.xml.rpc.*;

import com.iona.jbus.Bus;
import com.iona.jbus.ContextRegistry;
import com.iona.jbus.IonaMessageContext;
import com.iona.schemas.bus.security_context.BusSecurity;
...
// Set the BuSecurity Context
//-----
// Insert the following lines of code prior to making a
// WS-secured invocation:

1 BusSecurity security = new BusSecurity();
  security.setWSSEUsernameToken("user_test");
  security.setWSSEPasswordToken("user_password");

2 QName SECURITY_CONTEXT =
    new QName (
        "http://schemas.ionas.com/bus/security_context",
        "bus-security"
    );

3 ContextRegistry registry = bus.getContextRegistry();
4 IonaMessageContext contextimpl =
    (IonaMessageContext)registry.getCurrent();
5 contextimpl.setRequestContext(SECURITY_CONTEXT, security);
...

```

1. Create a new `com.iona.schemas.bus.security_context.BusSecurity` object to hold the context data and initialize the `WSSEUsernameToken` and `WSSEPasswordToken` properties on this `BusSecurity` object.
2. Initialize the name of the bus-security context. Because the bus-security context type is pre-registered by the Artix runtime (thus fixing the context name) the bus-security name must be set to the value shown here.



3. The `com.ionajbus.ContextRegistry` object manages all of the context objects for the application.
4. The `com.ionajbus.IonaMessageContext` object returned from `getCurrent()` holds all of the context data objects associated with the current thread.
5. Call `setRequestContext()` to initialize the `bus-security` context for outgoing request messages.

---

# Propagating a Kerberos Token

---

## Overview

Using the Kerberos Authentication Service requires you to make a few changes to your client code. First you need to acquire a valid Kerberos token. Then you need to embed it into the SOAP message header of all the requests being made on the secure server.

## Acquiring a Kerberos Token

To get a security token from the Kerberos Authentication Service, you must use platform specific APIs and then base64 encode the returned binary token so that it can be placed into the SOAP header.

On UNIX platforms, use the GSS APIs to contact Kerberos and get a token for the service you wish to make requests upon. On Windows platforms, use the Microsoft Security Framework APIs to contact Kerberos and get a token for the service you wish to contact.

## C++ embedding the Kerberos token in the SOAP header

Embedding a Kerberos token into the SOAP header of a request using the Artix APIs requires you to do the following:

1. If you use a SOAP 1.2 binding, make sure to load and configure the `artix_security` plug-in as described in [“Configuration for SOAP 1.2 Bindings” on page 540](#).
2. Make sure that your application makefile is configured to link with the `it_context_attribute` library (`it_context_attribute.lib` on Windows and `it_context_attribute.so` or `it_context_attribute.a` on UNIX) which contains the `bus-security` context stub code.
3. Get a reference to the current `IT_ContextAttributes::BusSecurity` context data type, using the Artix context API (see *Developing Artix Applications in C++*).
4. Set the `WSSEKerberosv5SToken` property on the `BusSecurity` context using the `setWSSEKerberosv5SToken()` method.

**C++ Example**

[Example 124](#) shows how to set the Kerberos token prior to invoking a remote operation.

**Example 124: Setting a Kerberos Token on the Client Side**

```
// C++

#include <it_bus/bus.h>
#include <it_bus/exception.h>
#include <it_cal/iostream.h>

// Include header files related to the bus-security context
#include <it_bus_pdk/context.h>
#include <it_bus_pdk/context_attrs/bus_security_xsdTypes.h>

IT_USING_NAMESPACE_STD

using namespace IT_ContextAttributes;
using namespace IT_Bus;

int
main(int argc, char* argv[])
{
    try
    {
        IT_Bus::Bus_var bus = IT_Bus::init(argc, argv);

        ContextRegistry* context_registry =
            bus->get_context_registry();

        // Obtain a reference to the ContextCurrent
        ContextCurrent& context_current =
            context_registry->get_current();

        // Obtain a pointer to the Request ContextContainer
        ContextContainer* context_container =
            context_current.request_contexts();

        // Obtain a reference to the context
        AnyType* info = context_container->get_context(
            IT_ContextAttributes::SECURITY_SERVER_CONTEXT,
            true
        );
    }
}
```

1

**Example 124:** *Setting a Kerberos Token on the Client Side*

```

2      // Cast the context into a BusSecurity object
      BusSecurity* bus_security_ctx =
          dynamic_cast<BusSecurity*> (info);

3      // Set the Kerberos token
      bus_security_ctx->setWSSEKerberosv5SToken(
          kerberos_token_string
      );
      ...
    }
    catch(IT_Bus::Exception& e)
    {
        cout << endl << "Error : Unexpected error occurred!"
             << endl << e.message()
             << endl;
        return -1;
    }
    return 0;
}

```

The preceding code can be explained as follows:

1. The `IT_Bus::ContextContainer::get_context()` function is called with its second parameter set to `true`, indicating that a context with that name will be created if none already exists.
2. Cast the `IT_Bus::AnyType` instance, `info`, to its derived type, `IT_ContextAttributes::BusSecurity`, which is the bus-security context data type.
3. Use the `BusSecurity` API to set the WSS Kerberos token, `kerberos_token_string`. The argument to `setWSSEKerberosv5SToken()` is a base-64 encoded Kerberos token received from a Kerberos server.

The next operation invoked from this thread will include the specified Kerberos token in the request message.

## Java embedding the Kerberos token in the SOAP header

Embedding a Kerberos token into the SOAP header of a request in Artix Java requires you to do the following:

1. If you use a SOAP 1.2 binding, make sure to load and configure the `artix_security` plug-in as described in [“Configuration for SOAP 1.2 Bindings” on page 540](#).
2. Create a new `com.ionaschemas.bus.security_context.BusSecurity` context data object.
3. Set the `WSSEKerberosv2SToken` property on the `BusSecurity` context using the `setWSSEKerberosv2SToken()` method.
4. Set the bus-security context for the outgoing request message by calling `setRequestContext()` on an `IonaMessageContext` object (see *Developing Artix Applications in Java*).

## Java Example

[Example 125](#) shows how to set the Kerberos token in a Java client prior to invoking a remote operation.

### Example 125: Setting a Kerberos Token in a Java Client

```
// Java
import javax.xml.namespace.QName;
import javax.xml.rpc.*;

import com.ionaschemas.bus.security_context.BusSecurity;
...
// Set the BusSecurity Context
//-----
// Insert the following lines of code prior to making a
// WS-secured invocation:

1 BusSecurity security = new BusSecurity();
  security.setWSSEKerberosv2SToken(kerberos_token_string);

2 QName SECURITY_CONTEXT =
  new QName(
    "http://schemas.ionaschemas.com/bus/security_context",
    "bus-security"
  );
```

**Example 125:** *Setting a Kerberos Token in a Java Client*

```
3 ContextRegistry registry = bus.getContextRegistry();
4 IonaMessageContext contextimpl =
  (IonaMessageContext) registry.getCurrent();
5 contextimpl.setRequestContext (SECURITY_CONTEXT, security);
  ...
```

1. Create a new `com.iona.schemas.bus.security_context.BusSecurity` object to hold the context data and initialize the `WSSEKerberosv2SToken` on this `BusSecurity` object. The argument to `setWSSEKerberosv5SToken()` is a base-64 encoded Kerberos token received from a Kerberos server.
2. Initialize the name of the bus-security context. Because the bus-security context type is pre-registered by the Artix runtime (thus fixing the context name) the bus-security name must be set to the value shown here.
3. The `com.iona.jbus.ContextRegistry` object manages all of the context objects for the application.
4. The `com.iona.jbus.IonaMessageContext` object returned from `getCurrent()` holds all of the context data objects associated with the current thread.
5. Call `setRequestContext()` to initialize the bus-security context for outgoing request messages.

---

# Propagating an X.509 Certificate

---

## Overview

Artix lets you propagate an X.509 certificate inside a SOAP header, as specified in the WSS standard. You need to program the client to insert a certificate into outgoing SOAP headers and program the server to extract the certificate from the incoming SOAP headers.

## C++ Procedure

Embedding an X.509 certificate into the SOAP header of a request in Artix C++ requires you to do the following:

1. If you use a SOAP 1.2 binding, make sure to load and configure the `artix_security` plug-in as described in [“Configuration for SOAP 1.2 Bindings”](#) on page 540.
2. Make sure that your application makefile is configured to link with the `it_context_attribute` library (`it_context_attribute.lib` on Windows and `it_context_attribute.so` or `it_context_attribute.a` on UNIX) which contains the `bus-security` context stub code.
3. Get a reference to the current `IT_ContextAttributes::BusSecurity` context data type, using the Artix context API (see *Developing Artix Applications in C++*).
4. Set the `WSSEX509Cert` property on the `BusSecurity` context using the `setWSSEX509Cert()` method.

## C++ Example

[Example 126](#) shows how to insert an X.509 certificate into a WSS SOAP header in a C++ client prior to invoking a remote operation.

**Example 126:** *Setting a WSS X.509 Certificate in a C++ Client*

```
// C++
#include <it_bus/bus.h>
#include <it_bus/exception.h>
#include <it_cal/iostream.h>

// Include header files related to the bus-security context
#include <it_bus_pdk/context.h>
#include <it_bus_pdk/context_attrs/bus_security_xsdTypes.h>
```

**Example 126:** *Setting a WSS X.509 Certificate in a C++ Client*

```

IT_USING_NAMESPACE_STD

using namespace IT_ContextAttributes;
using namespace IT_Bus;

int
main(int argc, char* argv[])
{
    try
    {
        IT_Bus::Bus_var bus = IT_Bus::init(argc, argv);

        ContextRegistry* context_registry =
            bus->get_context_registry();

        // Obtain a reference to the ContextCurrent
        ContextCurrent& context_current =
            context_registry->get_current();

        // Obtain a pointer to the Request ContextContainer
        ContextContainer* context_container =
            context_current.request_contexts();

        // Obtain a reference to the context
1       AnyType* info = context_container->get_context(
            IT_ContextAttributes::SECURITY_SERVER_CONTEXT,
            true
        );

        // Cast the context into a BusSecurity object
2       BusSecurity* bus_security_ctx =
            dynamic_cast<BusSecurity*>(info);

        // Read the WSS X.509 Certificate
3       char x509_cert[10000];
        read_certificate(
            "sample_cert.pem",
            x509_cert
        );

        // Set the WSS X.509 Certificate
4       bus_security_ctx->setWSSEX509Cert(x509_cert);
        ...
    }
    catch(IT_Bus::Exception& e)

```



**Example 126:** *Setting a WSS X.509 Certificate in a C++ Client*

```

{
    cout << endl << "Error : Unexpected error occurred!"
         << endl << e.message()
         << endl;
    return -1;
}
return 0;
}

```

The preceding code can be explained as follows:

1. Call the `IT_Bus::ContextContainer::get_context()` function to obtain a pointer to a `BusSecurity` object. The first parameter is the `QName` of the `BusSecurity` context and the second parameter is set to `true`, indicating that a context with that `QName` will be created if none already exists.
2. Cast the `IT_Bus::AnyType` instance, `info`, to its derived type, `IT_ContextAttributes::BusSecurity`, which is the bus-security context data type.
3. Read the certificate from some external source. The X.509 certificate must be in Privacy Enhanced Mail (PEM) format (which is a format proprietary to the OpenSSL product). For example, you might read the certificate from a file with the following implementation of the `read_certificate()` function:

```

// C++
void
read_certificate(
    const char* filename,
    char*      cert
)
{
    char buf[5000];
    strcpy(cert, "\0");
    FILE *is;
    if ((is = fopen(filename, "rb")) == NULL)
    {
        fprintf(stdout, "Can't open %s", filename);
        return;
    }
}

```

```

int n = 200;
while(fgets(buf, n, is) != 0)
{
    strcat(cert, buf, strlen(buf));
}

fclose(is);
}

```

4. Use the BusSecurity API to set the X.509 certificate for sending in the WSS SOAP header. After this point, any SOAP operations invoked from the current thread will include the specified WSS X.509 certificate in the request message.

### Java Procedure

Embedding an X.509 certificate into the SOAP header of a request in Artix Java requires you to do the following:

1. If you use a SOAP 1.2 binding, make sure to load and configure the `artix_security` plug-in as described in [“Configuration for SOAP 1.2 Bindings” on page 540](#).
2. Create a new `com.iona.schemas.bus.security_context.BusSecurity` context data object.
3. Set the `WSSEX509Cert` property on the `BusSecurity` context using the `setWSSEX509Cert()` method.
4. Set the bus-security context for the outgoing request message by calling `setRequestContext()` on an `IonaMessageContext` object (see *Developing Artix Applications in Java*).

### Java Example

[Example 127](#) shows how to insert an X.509 certificate into a WSS SOAP header in a Java client prior to invoking a remote operation.

#### Example 127: Setting a WSS X.509 Certificate in a Java Client

```

// Java
import javax.xml.namespace.QName;
import javax.xml.rpc.*;

import com.iona.jbus.Bus;
import com.iona.jbus.ContextRegistry;
import com.iona.jbus.IonaMessageContext;
import com.iona.schemas.bus.security_context.BusSecurity;

```

**Example 127:** *Setting a WSS X.509 Certificate in a Java Client*

```

...
// Set the BusSecurity Context
//-----
// Insert the following lines of code prior to making a
// WS-secured invocation:
1 BusSecurity security = new BusSecurity();
  java.lang.String x509_cert = ... // Get X.509 cert.
  security.setWSSEX509Cert(x509_cert);
2 QName SECURITY_CONTEXT =
    new QName(
        "http://schemas.iona.com/bus/security_context",
        "bus-security"
    );
3 ContextRegistry registry = bus.getContextRegistry();
4 IonaMessageContext contextimpl =
    (IonaMessageContext) registry.getCurrent();
5 contextimpl.setRequestContext(SECURITY_CONTEXT, security);
...

```

1. Use the `BusSecurity` API to set the X.509 certificate in the WSS SOAP header.
2. Initialize the name of the bus-security context. Because the bus-security context type is pre-registered by the Artix runtime (thus fixing the context name) the bus-security name must be set to the value shown here.
3. The `com.iona.jbus.ContextRegistry` object manages all of the context objects for the application.
4. The `com.iona.jbus.IonaMessageContext` object returned from `getCurrent()` holds all of the context data objects associated with the current thread.
5. Call `setRequestContext()` to initialize the bus-security context for outgoing request messages.



# Programming Authentication— Java Runtime

*The Artix Java runtime provides a credentials API that enables you to create and set credentials on the consumer side and to retrieve and inspect received credentials on the service side.*

---

## In this chapter

This chapter discusses the following topics:

<a href="#">The Security Credentials Model</a>	<a href="#">page 558</a>
<a href="#">Creating and Sending Credentials</a>	<a href="#">page 564</a>
<a href="#">Retrieving Received Credentials</a>	<a href="#">page 569</a>
<a href="#">Endorsements</a>	<a href="#">page 575</a>

---

# The Security Credentials Model

---

## Overview

This section provides an overview of the main data types used to model credentials in the Artix Java runtime.

---

## Security protocol types

Credentials can be transmitted through different layers of the transport protocol stack (in fact, multiple layers can be used at the same time). In order to identify which layer a credential is transmitted through, the credential API defines the following enumerated constants in the `com.iona.cxf.security.types.SecurityProtocolType` enumeration:

- `SecurityProtocolType.TLS`
  - `SecurityProtocolType.HTTP`
  - `SecurityProtocolType.SOAP`
- 

## Credential types

The credential API defines the following credential types as enumerated constants in the `com.iona.cxf.security.types.CredentialType` enumeration:

- `CredentialType.CERTIFICATE`—an X.509 certificate chain, consisting of an X.509 certificate and (optionally) its associated CA certificates. See [“Certificate Chaining” on page 177](#) for more details.
- `CredentialType.TLS_PEER`—same as `CERTIFICATE`, augmented by the name of the cipher suite employed by the SSL/TLS connection.
- `CredentialType.USERNAME_PASSWORD`—a username and a password (independent of the particular protocol type).
- `CredentialType.IONA_SSO_TOKEN`—an opaque string token used by the Artix security service to identify a principal. See [“Single Sign-On” on page 389](#) for more details.
- `CredentialType.GSS_KRB_5_AP_REQ_TOKEN`—an opaque binary token acquired as a result of initializing a Kerberos security context, using a target Kerberos service name.

**Security protocol/credential type combinations**

Because of the multi-layered structure of the transport protocol stack, it is possible to combine credential types with more than one security protocol type. Table 16 shows a summary of the allowable security protocol/credential type combinations.

**Table 16:** *Combinations of Security Protocol and Credential Type*

Security Protocol Type	Credential Type	Protocol Description
TLS	CERTIFICATE	SSL/TLS handshake.
	TLS_PEER	SSL/TLS handshake.
HTTP	USERNAME_PASSWORD	HTTP Basic Authentication.
SOAP	USERNAME_PASSWORD	WS-Security username/password token.
	CERTIFICATE	WS-Security binary security token.
	IONA_SSO_TOKEN	WS-Security binary security token.
	GSS_KRB_5_AP_REQ_TOKEN	WS-Security binary security token.

**The credential API**

Figure 53 provides an overview of the Java interface hierarchy for the most important credential interface types.

**Figure 53:** *Artix Credential API*

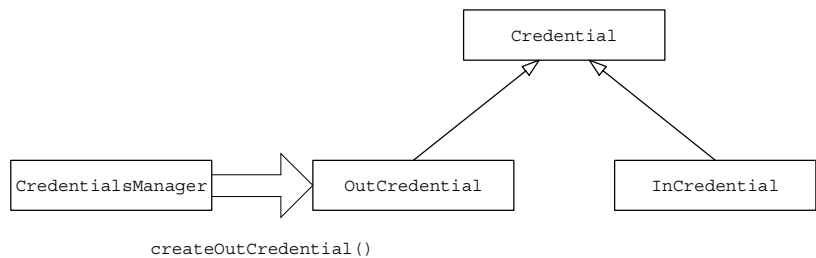

## Credential interface

[Example 128](#) shows the `com.ionafx.security.credential.Credential` interface, which is the base type for all credential types in the Artix credential API.

### Example 128: Credential Interface

```
// Java
package com.ionafx.security.credential;
import com.ionafx.security.types.CredentialType;
import java.util.Collection;

public interface Credential {
    CredentialType getCredentialType();
    Collection<? extends Credential> getEndorsements();
}
```

The `getCredentialType()` method returns a `CredentialType` enumeration constant (see [“Credential types” on page 558](#)). The `getEndorsements()` method returns a list of credentials that endorse the current credential—see [“Endorsements” on page 575](#) for more details.

## OutCredential interface

[Example 129](#) shows the `com.ionafx.security.credential.OutCredential` interface, which represents a credential that is to be *sent* in an outgoing operation request.

### Example 129: OutCredential Interface

```
// Java
package com.ionafx.security.credential;

public interface OutCredential extends Credential {
    // complete
}
```

It is possible to create `OutCredential` instances at the application programming level—see [“CredentialsManager bus extension” on page 561](#).



**InCredential interface**

[Example 130](#) shows the `com.iona.cxf.security.credential.InCredential` interface, which represents a credential that has been received from an incoming operation request.

**Example 130: *InCredential* Interface**

```
// Java
package com.iona.cxf.security.credential;
import com.iona.cxf.security.types.SecurityProtocolType;

public interface InCredential extends Credential {
    SecurityProtocolType getSecurityProtocolType();
}
```

The `getSecurityProtocolType()` method returns the enumerated constant that identifies the security protocol used to transmit the credential—see [“Security protocol types” on page 558](#).

It is *not* possible to create `InCredential` instances at the application programming level.

**CredentialsManager bus extension**

The *bus extension* mechanism is a feature of the Artix Java runtime that enables you to extend the core functionality of the runtime. In particular, the `com.iona.cxf.security.credential.CredentialsManager` bus extension encapsulates the security credentials functionality of the Artix Java runtime. As well as installing the security features, the `CredentialsManager` instance also exposes a public method to the application-level programmer, as shown in [Example 131](#).

**Example 131: *CredentialsManager* Interface**

```
// Java
package com.iona.cxf.security.credential;
import com.iona.cxf.security.types.CredentialType;

public interface CredentialsManager {
    OutCredential
    createOutCredential(
        CredentialType type,
        Object... args
    ) throws CredentialCreationException;
}
```

The `createOutCredential()` method is called in order to create an `OutCredential` object of arbitrary credential type. The created `OutCredential` object can subsequently be inserted into a request context in order to propagate it along with an operation invocation (see “[Creating and Sending Credentials](#)” on page 564).

### Multiple credentials for sending

Instead of adding credentials one-by-one to a JAX-WS request context, the Artix credential API takes the approach of assembling all of the credentials into a collection, represented by an `com.ionacxf.security.credential.OutCredentialsMap` object. The `OutCredentialsMap` object can then be inserted into the JAX-WS request context. [Figure 54](#) shows the structure of an `OutCredentialsMap` object.

**Figure 54:** *Multiple Credentials in an OutCredentialsMap*

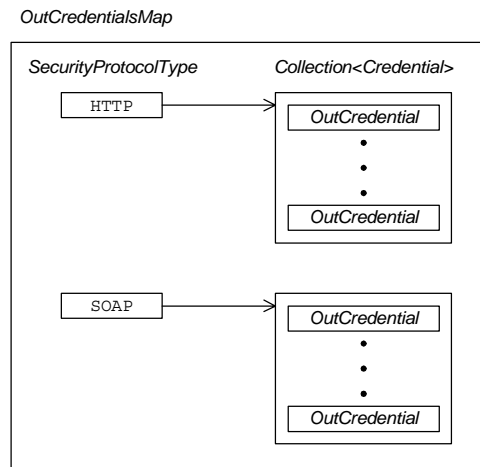

The `OutCredentialsMap` type is a map (of `java.util.Map` type) that associates each protocol key (for example, `TLS`, `HTTP`, or `SOAP`) with a collection of credentials. In this way, it is possible to associate one or more credential types with each layer of the transport protocol stack.

## Multiple received credentials

On the service end, the received credentials are also encapsulated in a single collection, which is of `com.ionafx.security.credential.InCredentialsMap` type. [Figure 55](#) shows the structure of an `InCredentialsMap` object.

**Figure 55:** *Multiple Credentials in an InCredentialsMap*

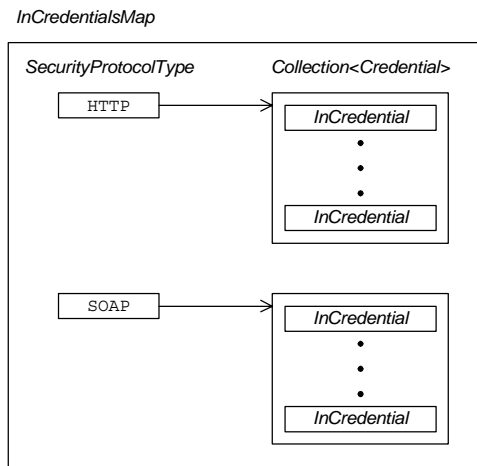

The structure of `InCredentialsMap` is similar to the structure of `OutCredentialsMap`, except that the contained credentials are derived from the `InCredential` type.

---

# Creating and Sending Credentials

---

## Overview

Using the credentials API you can associate a collection of credentials with a particular proxy object. The associated credentials will then be transmitted whenever you make an operation invocation on the proxy object (assuming that the credentials match the transport protocol used by the proxy).

---

## Creating credentials

To create a credential, you need first of all to obtain a `CredentialsManager` instance (see [“Sending credentials” on page 565](#)). You can then create an `OutCredential` object for any credential type, by calling the `CredentialsManager.createOutCredential()` method, which is defined in [Example 132](#).

### Example 132: *The createOutCredential() Method*

```
// Java
package com.ionafx.security.credential;
import com.ionafx.security.types.CredentialType;

public interface CredentialsManager {

    OutCredential
    createOutCredential(
        CredentialType type,
        Object... args
    ) throws CredentialCreationException;
}
```

**createOutCredential() parameters** The `createOutCredential()` method is a generic credential factory method, which can create any of the credential types shown in [Table 17](#).

**Table 17:** *Parameters for createOutCredential()*

Credential Type	Parameters for createOutCredential()
<code>CredentialType.USERNAME_PASSWORD</code>	<code>arg0 (required): String username,</code> <code>arg1 (required): String password.</code>
<code>CredentialType.IONA_SSO_TOKEN</code>	<code>arg0 (required): String IONA_SSO_Token.</code>
<code>CredentialType.GSS_KRB_5_AP_REQ_TOKEN</code>	<code>arg0 (required): byte[] GSS_Krb_V5_AP_REQ_Token.</code>

The first parameter of `createOutCredential()` is always of `CredentialType` type. The subsequent parameters are declared as `Object...`, which means that the number and type of those parameters depends on the particular credential type you are creating, as shown in [Table 17](#). For example, if you create an `OutCredential` of type `CredentialType.USERNAME_PASSWORD`, the second argument would be the username and the third argument would be the password.

## Sending credentials

On the client side, you can associate security credentials with a proxy object by inserting an `OutCredentialsMap` object into the proxy's *request context*. The JAX-WS request context is a mechanism that enables you to pass data to handlers in a handler chain. The security handlers installed by Artix will then read the `OutCredentialsMap` object and insert credentials into the appropriate transport headers in the outgoing request message. [Example 133](#) shows an example of how to insert the `OutCredentialsMap` object into the `Greeter` proxy's request context.

### Example 133: Sending Credentials Using JAX-WS Request Context

```
// Java
import javax.xml.ws.BindingProvider;
import java.util.Map;
import com.ionafx.security.credential.OutCredentialsMap;
import org.apache.cxf.BusFactory;
import org.apache.hello_world_soap_http.Greeter;
```

**Example 133:** *Sending Credentials Using JAX-WS Request Context*

```

OutCredentialsMap map = // create and populate an
    OutCredentialsMap (see example)

// Insert the credentials map on the request context
Greeter greeter = // get a reference to a client proxy
Map<String, Object> requestContext =
    ((BindingProvider)greeter).getRequestContext();
requestContext.put(
    OutCredentialsMap.class.getName(),
    map
);

// Invoke the sayHi operation with the above credentials
greeter.sayHi();

```

The request context is defined to be a map that associates string keys with objects of arbitrary type. For the out credentials map, use the fully qualified class name of `OutCredentialsMap` as the key.

**Scope of credentials and multi-threading**

Once an `OutCredentialsMap` object is associated with a proxy instance, all subsequent (and possibly concurrent) operations invoked on the proxy use the same `OutCredentialsMap` instance. Applications must therefore exercise caution when associating `OutCredentialsMap` instances with proxies in multi-threaded applications; in particular, the assignment of an entry on the request context associated with a proxy instance is not a thread-safe operation.

## JAX-WS example

[Example 134](#) shows a complete example of how to send out credentials with an operation invocation in a JAX-WS client program. This example shows how to initialize the username and password credential for the HTTP Basic Authentication protocol.

**Example 134:** *Example of Sending Credentials from a JAX-WS Client*

```
// Java
import java.io.File;
import java.net.URL;
import javax.xml.namespace.QName;
import javax.xml.ws.BindingProvider;
import javax.xml.ws.ProtocolException;

import
    com.ionacxf.security.credential.CredentialCreationException;
import com.ionacxf.security.credential.CredentialsManager;
import com.ionacxf.security.credential.OutCredential;
import com.ionacxf.security.credential.OutCredentialsMap;
import com.ionacxf.security.types.CredentialType;
import com.ionacxf.security.types.SecurityProtocolType;

import org.apache.cxf.BusFactory;

import org.apache.hello_world_soap_http.Greeter;
import org.apache.hello_world_soap_http.PingMeFault;
import org.apache.hello_world_soap_http.SOAPService;
import org.apache.hello_world_soap_http.types.FaultDetail;

1 CredentialsManager mgr =
    BusFactory.getDefaultBus().getExtension(
        CredentialsManager.class
    );
2 OutCredential cred = mgr.createOutCredential(
    CredentialType.USERNAME_PASSWORD,
    "tony",          // arg0 - Username
    "tonypass"     // arg1 - Password
);

// Associate the credential with the HTTP protocol
OutCredentialsMap map = new OutCredentialsMap();
3 map.get(SecurityProtocolType.HTTP).add(cred);

// Insert the credentials map on the request context
Greeter greeter = // get a reference to a client proxy
```

**Example 134:** *Example of Sending Credentials from a JAX-WS Client*

```

4 Map<String, Object> requestContext =
  ((BindingProvider)greeter).getRequestContext();
5 requestContext.put(
  OutCredentialsMap.class.getName(),
  map
  );

  // Invoke the sayHi operation with the above credentials
6 greeter.sayHi();

```

The preceding example can be explained as follows:

1. The `CredentialsManager` is a CXF bus extension that encapsulates the Artix credential features. In particular, it provides the method, `createOutCredential()`, that lets you create out credentials.
2. Create a username and password out credential by calling the `CredentialsManager.createOutCredential()` method. For more details about the parameters to `createOutCredential()`, see [“createOutCredential\(\) parameters” on page 565](#).
3. Add the username and password credential to the out credentials map, associating it with the HTTP transport layer (implicitly making a HTTP Basic Authentication credential).
4. Obtain a reference to the JAX-WS request context object for the `Greeter` proxy. The request context is a map that associates string keys with arbitrary Java objects.
5. Insert the out credentials map into the request context, using the fully-qualified class name of `OutCredentialsMap` as the key.
6. When you next invoke an operation on the `Greeter` proxy object, the username and password credential is transmitted in the HTTP header of the request message. The out credentials remain effective for all subsequent operations invoked on the `greeter` proxy instance.



---

# Retrieving Received Credentials

---

## Overview

This section explains how to access the credentials received from a consumer that has just invoked an operation on a secure service.

---

## Retrieving credentials

You can gain access to received credentials on the service side of an application by retrieving an `InCredentialsMap` object from the current message context (on the service side of the application). The `InCredentialsMap` instance encapsulates the received credentials for all applicable transport layers in the stack (see [“Multiple received credentials” on page 563](#)).

Once you have obtained the `InCredentialsMap` instance, you can extract credentials for particular transport layers and cast them to the appropriate leaf credential type. You can then use the applicable credential interface to extract the details of each credential.

---

## Retrievable credential types

The following credential types can potentially be retrieved from an `InCredentialsMap` instance:

### CertificateCredential

[Example 135](#) shows the definition of the `com.ionacxf.security.credential.CertificateCredential` interface. A certificate credential object contains an X.509 certificate chain—see [“Certificate Chaining” on page 177](#) for more details about certificate chains.

#### Example 135: *The CertificateCredential Interface*

```
// Java
package com.ionacxf.security.credential;
import java.util.List;

public interface CertificateCredential extends Credential {
    List<java.security.cert.Certificate> getCertificateChain();
}
```

**TlsPeerCredential**

[Example 136](#) shows the definition of the `com.iona.cxf.security.credential.TlsPeerCredential` interface. In addition to the data available from a `CertificateCredential` object, this credential type also provides the name of the cipher suite that is currently being used on the TLS peer connection.

**Example 136: The TlsPeerCredential Interface**

```
// Java
package com.iona.cxf.security.credential;

public interface TlsPeerCredential extends CertificateCredential
{
    String getCipherSuite();
}
```

**UsernamePasswordCredential**

[Example 137](#) shows the definition of the `com.iona.cxf.security.credential.UsernamePasswordCredential` interface. This credential type encapsulates a username and a password. It is *not* tied to any particular protocol type. You can use the `UsernamePasswordCredential` credential for any authentication method that demands a username and a password.

**Example 137: The UsernamePasswordCredential Interface**

```
// Java
package com.iona.cxf.security.credential;

public interface UsernamePasswordCredential extends Credential {
    String getUsername();
    String getPassword();
}
```

**IonaSSOTokenCredential**

[Example 138](#) shows the definition of the `com.iona.cxf.security.credential.IonaSSOTokenCredential` interface. The IONA SSO token is an opaque string that constitutes a reference to a

user identity in the Artix security service. It provides a compact form of credential that can be used within a system that is secured by the Artix security service—see [“Single Sign-On” on page 389](#).

**Example 138:** *The IonaSSOTokenCredential Interface*

```
// Java
package com.iona.cxf.security.credential;

public interface IonaSSOTokenCredential extends Credential {
    String getIonaSSOToken();
}
```

**GssKrb5ReqTokenCredential**

[Example 139](#) shows the definition of the

`com.iona.cxf.security.credential.GssKrb5ReqTokenCredential` interface. The Kerberos token is a binary token that provides the authorization to use a particular service. The Artix security service can be configured to accept Kerberos tokens—see [“Configuring the Kerberos Adapter” on page 301](#) for details.

**Example 139:** *The GssKrb5ApReqTokenCredential Interface*

```
// Java
package com.iona.cxf.security.credential;

public interface GssKrb5ApReqTokenCredential extends Credential
{
    byte[] getGssKrb5ApReqToken();
}
```

**Declaring WebServiceContext**

In order to inspect the credentials from an incoming request, you need to obtain a `WebServiceContext` instance for the service. [Example 140](#) shows how to declare a `WebServiceContext` instance, `ws_context`, in the implementation of the `Greeter` service.

**Example 140: Declaring WebServiceContext in a Service Implementation**

```
// Java
...
@javax.jws.WebService(name = "Greeter" ...)
public class GreeterImpl implements Greeter {
    @javax.annotation.Resource
    private javax.xml.ws.WebServiceContext ws_context;

    // Definitions of Greeter Methods
    ... // Not shown.
}
```

The `@Resource` annotation that precedes the declaration instructs the Artix runtime to populate the `ws_context` object by injection. In the context of a `Greeter` operation invocation, it then becomes possible to access a `MessageContext` instance through the `ws_context` object, as shown in [Example 141](#).

**JAX-WS example**

[Example 141](#) shows an example of how to extract a `UsernamePasswordCredential` instance from the current message context. You could use this code to access a client's username on the service side of an application that uses HTTP Basic Authentication.

**Example 141: Retrieving an InCredentialsMap Instance**

```
// Java
...
import java.util.Collection;
import java.util.logging.Logger;
import javax.annotation.Resource;
import javax.xml.ws.WebServiceContext;

import com.ionacxf.security.credential.InCredential;
import com.ionacxf.security.credential.InCredentialsMap;
import
    com.ionacxf.security.credential.UsernamePasswordCredential;
```

**Example 141:** *Retrieving an InCredentialsMap Instance*

```

import com.ionacxf.security.types.CredentialType;
import com.ionacxf.security.types.SecurityProtocolType;

import org.apache.hello_world_soap_http.Greeter;
import org.apache.hello_world_soap_http.PingMeFault;
import org.apache.hello_world_soap_http.types.FaultDetail;

@javax.jws.WebService(
    targetNamespace = "http://apache.org/hello_world_soap_http",
    serviceName = "SOAPService",
    portName = "SoapPort",
    endpointInterface =
        "org.apache.hello_world_soap_http.Greeter"
)
public class GreeterImpl implements Greeter {
1     @Resource
    protected WebServiceContext ctx;
    ...
    private static String
2     getHTTPUsername(WebServiceContext ctx) {
3         final InCredentialsMap inCreds =
            (InCredentialsMap) ctx.getMessageContext().get(
                InCredentialsMap.class.getName()
            );
            String username = null;
            if (inCreds != null) {
4                 final Collection<InCredential> creds =
                    inCreds.get(SecurityProtocolType.HTTP);
                    UsernamePasswordCredential cred = null;
5                 for (InCredential c : creds) {
                        if (c.getCredentialType() ==
6                            CredentialType.USERNAME_PASSWORD) {
                                cred = (UsernamePasswordCredential) c;
                                break;
                            }
                        }
                    if (cred != null) {
7                            username = cred.getUsername();
                        }
                    }
                return username;
            }
        }
    }
}

```

The preceding code example can be described as follows:

1. The `javax.xml.ws.WebServiceContext` instance is declared to be a `@javax.annotation.Resource`, which causes the Artix Java runtime to populate it by injection.
2. The `getHTTPUsername()` method is a private method that is declared here as a convenience. It lets you put all of the code required to extract the username from an incoming HTTP header in a single place. You can then call this function whenever the current thread is in an *invocation context* (that is, when the thread is processing an operation invocation).
3. This line of code obtains the `InCredentialsMap` instance from the current message context. First of all, the message context is extracted from the `WebServiceContext` instance by calling `getMessageContext()`. The message context consists of a map that maps string keys to objects of arbitrary type. To access the `InCredentialsMap` instance, pass in the fully-qualified class name of `InCredentialsMap` as the key. You can then cast the return value to the type, `InCredentialsMap`.

**Note:** This code fragment only works, if it executes in an operation invocation context. If the current thread is not processing an operation invocation, there is no `InCredentialsMap` available.

4. Obtain the collection of incoming credentials associated with the HTTP transport layer (for an overview of the in credentials data model, see [Figure 55 on page 563](#)).
5. You can use this special `for` loop syntax to iterate over all of the members of a `java.util.Collection`.
6. If you find a credential of the type you need, simply cast it to the correct type. For a list of available credential types, see [Table 16 on page 559](#).
7. You can now call any of the `UsernamePasswordCredential` methods to access the contents of the credential (see [Example 137 on page 570](#)).

---

# Endorsements

---

## Overview

A *credential endorsement* is a relationship between credential instances, such that the endorser of the credential vouches for, or endorses, the data in an endorsed credential instance. For example, a credential representing a signature on a document can be an endorsement of the data in the document. Alternatively, credentials representing an identity authenticated over a securely negotiated security context, such as an SSL session, can endorse, or vouch for credentials that are delivered over that security context (for example, a username or a password).

Using endorsements, credential receivers can have greater confidence in the reliability of credential instances they receive and process. For example, if a received credential is not endorsed by an entity the credential receiver trusts, the request could be rejected.

**Note:** The implementation of such endorsement checking logic is application-specific and is therefore outside of the scope of the Artix Java security runtime.

## Accessing credential endorsements

While populating the `InCredentialsMap` instance from a received request message, the Artix security runtime attempts to build a list of endorsements for each `InCredential` object. The list of endorsements is based on information about the underlying properties of the request, such as whether the request is protected by a negotiated security context—for example, a TLS handshake.

To access the list of endorsements for a particular `Credentials` object, simply call the `Credential.getEndorsements()` method on the object. The `getEndorsements()` method has the following signature:

```
// Java
java.util.Collection<? extends Credential> getEndorsements();
```

Where the return value is a list (of `java.util.Collection` type) of all the credentials that endorse the current credential.

**Default endorsers**

By default, the Artix security runtime automatically endorses received credentials as follows:

- *HTTP Basic Authentication received credentials*—requires that the underlying connection is secured by SSL/TLS encryption. A client certificate is *not* required.
- *WSS UsernameToken received credentials*—requires that the underlying connection is secured by SSL/TLS encryption. A client certificate is *not* required.
- *WSS BinarySecurityToken received credentials*—endorsed by the client’s X.509 certificate, provided the underlying connection is secured by SSL/TLS encryption.

**Custom endorsers**

While the Artix security runtime can make some judgements about which credentials are suitable as endorsements, applications may have specific criteria for building up endorsement lists. Consequently, the Artix security runtime provides applications with an opportunity to perform application-specific credential endorsements.

The mechanism for performing application-specific credential endorsement is through the `CredentialEndorser` interface. This interface provides a hook into the credential endorsement process, allowing applications to provide their own endorsements, if required.

**The CredentialEndorser interface**

[Example 142](#) shows the definition of the `CredentialEndorser` interface.

**Example 142: The CredentialEndorser Interface**

```
// Java
package com.iona.cxf.security.credential;

public interface CredentialEndorser {

    Collection<InCredential> getEndorsements(
        Credential endorsee,
        InCredentialsMap map
    )
    throws CredentialEndorsementException;
}
```



Where the interface consists of one method, `getEndorsements()`, which takes a `Credential` argument, the credential under consideration for endorsement, along with the current `InCredentialsMap`, representing the set of credentials currently available in the execution context.

To implement the `getEndorsements()` method, write code as appropriate to inspect the `InCredentialsMap` argument for candidate endorsers, and then return the selected endorsers back to the Artix security runtime in the form of a `java.util.Collection` instance.

You can throw a `CredentialEndorsementException`, if the construction of the endorsement collection fails for any reason.

---

### Configuring the custom endorser

After you have written the custom endorser class and placed it on your application's CLASSPATH, you can configure an authentication element to use the endorser by setting the `credentialEndorser` attribute equal to the name of your endorser class.

For example, say you have just implemented an endorser class, `org.acme.CustomCredentialEndorser`. You can configure a server to apply this endorser to incoming HTTP Basic Authentication credentials by configuring the relevant `security:HTTPBASServerConfig` element as follows:

```
<security:HTTPBASServerConfig
  aclURL="ACLFile"
  aclServerName="ServerName"
  authorizationRealm="RealmName"
  credentialEndorser="org.acme.CustomCredentialEndorser"
/>
```

See [“Selecting Credentials to Authenticate” on page 369](#) for more details about configuring authentication elements.



# Developing an iSF Adapter

*An iSF adapter is a replaceable component of the iSF server module that enables you to integrate iSF with any third-party enterprise security service. This chapter explains how to develop and configure a custom iSF adapter implementation.*

## In this chapter

This chapter discusses the following topics:

<a href="#">iSF Security Architecture</a>	<a href="#">page 580</a>
<a href="#">iSF Server Module Deployment Options</a>	<a href="#">page 584</a>
<a href="#">iSF Adapter Overview</a>	<a href="#">page 586</a>
<a href="#">Implementing the IS2Adapter Interface</a>	<a href="#">page 587</a>
<a href="#">Deploying the Adapter</a>	<a href="#">page 597</a>

---

# iSF Security Architecture

---

## Overview

This section introduces the basic components and concepts of the iSF security architecture, as follows:

- [Architecture](#).
- [iSF client](#).
- [iSF client SDK](#).
- [Artix Security Service](#).
- [iSF adapter SDK](#).
- [iSF adapter](#).
- [Example adapters](#).

## Architecture

Figure 56 gives an overview of the Artix Security Service, showing how it fits into the overall context of a secure system.

**Figure 56:** *Overview of the Artix Security Service*

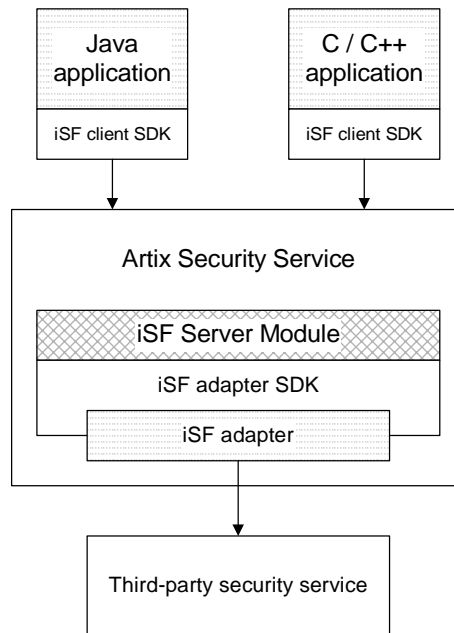

## iSF client

An iSF client is an application that communicates with the Artix Security Service to perform authentication and authorization operations. The following are possible examples of iSF client applications:

- CORBA servers.
- Artix servers.
- Any server that has a requirement to authenticate its clients.

Hence, an iSF client can also be a server. It is a client only with respect to the Artix Security Service.

---

**iSF client SDK**

The *iSF client SDK* is the programming interface that enables the iSF clients to communicate (usually remotely) with the Artix Security Service.

**Note:** The iSF client SDK is only used internally. It is currently not available as a public programming interface.

---

**Artix Security Service**

The Artix Security Service is a standalone process that acts a thin wrapper layer around the iSF server module. On its own, the iSF server module is a Java library which could be accessed only through local calls. By embedding the iSF server module within the Artix Security Service, however, it becomes possible to access the security service remotely.

---

**iSF server module**

The *iSF server module* is a broker that mediates between iSF clients, which request the security service to perform security operations, and a third-party security service, which is the ultimate repository for security data.

The *iSF server module* has the following special features:

- A replaceable iSF adapter component that enables integration with a third-party enterprise security service.
  - A single sign-on feature with user session caching.
- 

**iSF adapter SDK**

The *iSF adapter SDK* is the Java API that enables a developer to create a custom iSF adapter that plugs into the iSF server module.

---

**iSF adapter**

An *iSF adapter* is a replaceable component of the iSF server module that enables you to integrate with any third-party enterprise security service. An iSF adapter implementation provides access to a repository of authentication data and (optionally) authorization data as well.

---

**Example adapters**

The following standard adapters are provided with Artix:

- Lightweight Directory Access Protocol (LDAP).
- File—a simple adapter implementation that stores authentication and authorization data in a flat file.

**WARNING:** The file adapter is intended for demonstration purposes only. It is not industrial strength and is *not* meant to be used in a production environment.

# iSF Server Module Deployment Options

## Overview

The iSF server module, which is fundamentally implemented as a Java library, can be deployed in one of the following ways:

- [CORBA service](#).
- [Java library](#).

## CORBA service

The iSF server module can be deployed as a CORBA service (Artix Security Service), as shown in [Figure 57](#). This is the default deployment model for the iSF server module in Artix. This deployment option has the advantage that any number of distributed iSF clients can communicate with the iSF server module over IIOP/TLS.

With this type of deployment, the iSF server module is packaged as an application plug-in to the Orbix *generic server*. The Artix Security Service can be launched by the `itsecurity` executable and basic configuration is set in the `iona_services.security` scope of the Artix configuration file.

**Figure 57:** *iSF Server Module Deployed as a CORBA Service*

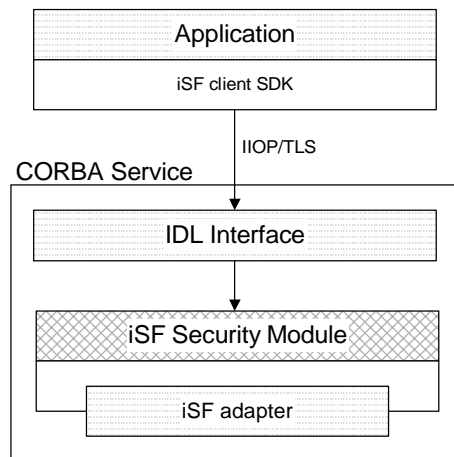



**Java library**

The iSF server module can be deployed as a Java library, as shown in [Figure 58](#), which permits access to the iSF server module from a single iSF client only.

With this type of deployment, the iSF security JAR file is loaded directly into a Java application. The security service is then instantiated as a local object and all calls made through the iSF client SDK are local calls.

**Figure 58:** *iSF Server Module Deployed as a Java Library*

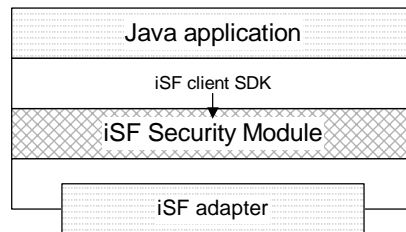

---

# iSF Adapter Overview

---

## Overview

This section provides an overview of the iSF adapter architecture. The modularity of the iSF server module design makes it relatively straightforward to implement a custom iSF adapter written in Java.

---

## Standard iSF adapters

IONA provides several ready-made adapters that are implemented with the iSF adapter API. The following standard adapters are currently available:

- File adapter.
- LDAP adapter.

---

## Custom iSF adapters

The iSF server module architecture also allows you to implement your own custom iSF adapter and use it instead of a standard adapter.

---

## Main elements of a custom iSF adapter

The main elements of a custom iSF adapter are, as follows:

- [Implementation of the iSF Adapter Java interface.](#)
- [Configuration of the iSF adapter using the iSF properties file.](#)

---

## Implementation of the iSF Adapter Java interface

The only code that needs to be written to implement an iSF adapter is a class to implement the `IS2Adapter` Java interface. The adapter implementation class should respond to authentication requests either by checking a repository of user data or by forwarding the requests to a third-party enterprise security service.

---

## Configuration of the iSF adapter using the iSF properties file

The iSF adapter is configured by setting Java properties in the `is2.properties` file. The `is2.properties` file stores two kinds of configuration data for the iSF adapter:

- Configuration of the iSF server module to load the adapter—see [“Configuring iSF to Load the Adapter” on page 598](#).
- Configuration of the adapter itself—see [“Setting the Adapter Properties” on page 599](#).

---

# Implementing the IS2Adapter Interface

---

## Overview

The `com.iona.security.is2adapter` package defines an `IS2Adapter` Java interface, which a developer must implement to create a custom iSF adapter. The methods defined on the `ISFAdapter` class are called by the iSF server module in response to requests received from iSF clients.

This section describes a simple example implementation of the `IS2Adapter` interface, which is capable of authenticating a single test user with hard-coded authorization properties.

---

## Test user

The example adapter implementation described here permits authentication of just a single user, `test_user`. The test user has the following authentication data:

Username: `test_user`  
Password: `test_password`

and the following authorization data:

- The user's global realm contains the `GuestRole` role.
  - The user's `EngRealm` realm contains the `EngineerRole` role.
  - The user's `FinanceRealm` realm contains the `AccountantRole` role.
- 

## iSF adapter example

[Example 143](#) shows a sample implementation of an iSF adapter class, `ExampleAdapter`, that permits authentication of a single user. The user's username, password, and authorization are hard-coded. In a realistic system, however, the user data would probably be retrieved from a database or from a third-party enterprise security system.

### Example 143: Sample ISF Adapter Implementation

```
import com.iona.security.azmgr.AuthorizationManager;
import com.iona.security.common.AuthenticatedPrincipal;
import com.iona.security.common.Realm;
import com.iona.security.common.Role;
import com.iona.security.is2adapter.IS2Adapter;
import com.iona.security.is2adapter.IS2AdapterException;
import java.util.Properties;
import java.util.ArrayList;
import java.security.cert.X509Certificate;
```

**Example 143:** *Sample ISF Adapter Implementation*

```

import org.apache.log4j.*;
import java.util.ResourceBundle;

import java.util.MissingResourceException;

public class ExampleAdapter implements IS2Adapter {

    public final static String EXAMPLE_PROPERTY =
        "example_property";

    public final static String ADAPTER_NAME = "ExampleAdapter";

1 private final static String MSG_EXAMPLE_ADAPTER_INITIALIZED
    = "initialized";
    private final static String MSG_EXAMPLE_ADAPTER_CLOSED
    = "closed";
    private final static String MSG_EXAMPLE_ADAPTER_AUTHENTICATE
    = "authenticate";
    private final static String
MSG_EXAMPLE_ADAPTER_AUTHENTICATE_REALM =
    "authenticate_realm";
    private final static String
MSG_EXAMPLE_ADAPTER_AUTHENTICATE_OK = "authenticateok";
    private final static String MSG_EXAMPLE_ADAPTER_GETAUTHINFO
    = "getauthinfo";
    private final static String
MSG_EXAMPLE_ADAPTER_GETAUTHINFO_OK = "getauthinfook";

    private ResourceBundle _res_bundle = null;

2 private static Logger LOG =
    Logger.getLogger(ExampleAdapter.class.getName());

    public ExampleAdapter() {
3 _res_bundle = ResourceBundle.getBundle("ExampleAdapter");
    LOG.setResourceBundle(_res_bundle);
    }

4 public void initialize(Properties props)
    throws IS2AdapterException {

    LOG.l7dlog(Priority.INFO, ADAPTER_NAME + "." +
MSG_EXAMPLE_ADAPTER_INITIALIZED,null);

```

**Example 143:** *Sample ISF Adapter Implementation*

```

// example property
String propVal = props.getProperty(EXAMPLE_PROPERTY);
LOG.info(propVal);

}

5 public void close() throws IS2AdapterException {
    LOG.17dlog(Priority.INFO, ADAPTER_NAME + "." +
MSG_EXAMPLE_ADAPTER_CLOSED, null);
}

6 public AuthenticatedPrincipal authenticate(String username,
String password)
throws IS2AdapterException {

7     LOG.17dlog(Priority.INFO, ADAPTER_NAME + "." +
MSG_EXAMPLE_ADAPTER_AUTHENTICATE,new
Object [] {username,password}, null);

    AuthenticatedPrincipal ap = null;
    try{
        if (username.equals("test_user")
8            && password.equals("test_password")){
            ap = getAuthorizationInfo(new
AuthenticatedPrincipal(username));
        }
        else {
9            LOG.17dlog(Priority.WARN, ADAPTER_NAME + "." +
IS2AdapterException.WRONG_NAME_PASSWORD,null);
            throw new IS2AdapterException(_res_bundle,this,
IS2AdapterException.WRONG_NAME_PASSWORD, new
Object [] {username});
        }

    } catch (Exception e) {
        LOG.17dlog(Priority.WARN, ADAPTER_NAME + "." +
IS2AdapterException.AUTH_FAILED,e);
        throw new IS2AdapterException(_res_bundle,this,
IS2AdapterException.AUTH_FAILED, new Object [] {username}, e);
    }

    LOG.17dlog(Priority.WARN, ADAPTER_NAME + "." +
MSG_EXAMPLE_ADAPTER_AUTHENTICATE_OK,null);
    return ap;

```

**Example 143:** *Sample ISF Adapter Implementation*

```

    }

10 public AuthenticatedPrincipal authenticate(String realmname,
String username, String password)
throws IS2AdapterException {

    LOG.17dlog(Priority.INFO, ADAPTER_NAME + "." +
MSG_EXAMPLE_ADAPTER_AUTHENTICATE_REALM,new
Object [] {realmname,username,password},null);

    AuthenticatedPrincipal ap = null;
    try{
        if (username.equals("test_user")
11      && password.equals("test_password")){
AuthenticatedPrincipal principal = new
AuthenticatedPrincipal(username);
principal.setCurrentRealm(realmname);
ap = getAuthorizationInfo(principal);
        }
        else {
            LOG.17dlog(Priority.WARN, ADAPTER_NAME + "." +
IS2AdapterException.WRONG_NAME_PASSWORD,null);
            throw new IS2AdapterException(_res_bundle, this,
IS2AdapterException.WRONG_NAME_PASSWORD, new
Object [] {username});
        }

    } catch (Exception e) {
        LOG.17dlog(Priority.WARN, ADAPTER_NAME + "." +
IS2AdapterException.AUTH_FAILED,e);
        throw new IS2AdapterException(_res_bundle, this,
IS2AdapterException.AUTH_FAILED, new Object [] {username}, e);
    }

    LOG.17dlog(Priority.WARN, ADAPTER_NAME + "." +
MSG_EXAMPLE_ADAPTER_AUTHENTICATE_OK,null);
    return ap;
}

12 public AuthenticatedPrincipal authenticate(X509Certificate
certificate)
throws IS2AdapterException {
    throw new IS2AdapterException(
        _res_bundle, this,
IS2AdapterException.NOT_IMPLEMENTED

```

**Example 143:** *Sample ISF Adapter Implementation*

```

    );
}

13 public AuthenticatedPrincipal authenticate(String realm,
X509Certificate certificate)
throws IS2AdapterException {
    throw new IS2AdapterException(
        _res_bundle, this,
14 IS2AdapterException.NOT_IMPLEMENTED
    );
}

14 public AuthenticatedPrincipal
getAuthorizationInfo(AuthenticatedPrincipal principal) throws
IS2AdapterException{

    LOG.l7dlog(Priority.INFO, ADAPTER_NAME + "." +
MSG_EXAMPLE_ADAPTER_GETAUTHINFO,new
Object [] {principal.getUserID()},null);

    AuthenticatedPrincipal ap = null;
    String username = principal.getUserID();
    String realmname = principal.getCurrentRealm();

    try{
15         if (username.equals("test_user")) {
16             ap = new AuthenticatedPrincipal(username);
17             ap.addRole(new Role("GuestRole", ""));

17             if (realmname == null || (realmname != null &&
realmname.equals("EngRealm")))
                {
                    ap.addRealm(new Realm("EngRealm", ""));
                    ap.addRole("EngRealm", new
18 Role("EngineerRole", ""));
                }
                if (realmname == null || (realmname != null &&
realmname.equals("FinanceRealm")))
                {
                    ap.addRealm(new Realm("FinanceRealm",""));
                    ap.addRole("FinanceRealm", new
Role("AccountantRole", ""));
                }
            }
}
}

```

**Example 143:** *Sample ISF Adapter Implementation*

```

        else {
            LOG.l7dlog(Priority.WARN, ADAPTER_NAME + "." +
                IS2AdapterException.USER_NOT_EXIST, new Object[] {username},
                null);
            throw new IS2AdapterException(_res_bundle, this,
                IS2AdapterException.USER_NOT_EXIST, new Object[] {username});
        }

        } catch (Exception e) {
            LOG.l7dlog(Priority.WARN, ADAPTER_NAME + "." +
                IS2AdapterException.AUTH_FAILED,e);
            throw new IS2AdapterException(_res_bundle, this,
                IS2AdapterException.AUTH_FAILED, new Object[] {username}, e);
        }

        LOG.l7dlog(Priority.WARN, ADAPTER_NAME + "." +
            MSG_EXAMPLE_ADAPTER_GETAUTHINFO_OK,null);
        return ap;
    }

19     public AuthenticatedPrincipal getAuthorizationInfo(String
        username) throws IS2AdapterException{

            // this method has been deprecated
            throw new IS2AdapterException(
                _res_bundle, this,
                IS2AdapterException.NOT_IMPLEMENTED
            );
        }

20     public AuthenticatedPrincipal getAuthorizationInfo(String
        realmname, String username) throws IS2AdapterException{

            // this method has been deprecated
            throw new IS2AdapterException(
                _res_bundle, this,
                IS2AdapterException.NOT_IMPLEMENTED
            );
        }

21     public ArrayList getAllUsers()
        throws IS2AdapterException {

```



**Example 143:** *Sample ISF Adapter Implementation*

```

        throw new IS2AdapterException(
            _res_bundle, this,
            IS2AdapterException.NOT_IMPLEMENTED
        );

    }

22     public void logout(AuthenticatedPrincipal ap) throws
        IS2AdapterException {

    }
}

```

The preceding iSF adapter code can be explained as follows:

1. These lines list the keys to the messages from the adapter's resource bundle. The resource bundle stores messages used by the Log4J logger and exceptions thrown in the adapter.
2. This line creates a Log4J logger.
3. This line loads the resource bundle for the adapter.
4. The `initialize()` method is called just after the adapter is loaded. The properties passed to the `initialize()` method, `props`, are the adapter properties that the iSF server module has read from the `is2.properties` file. See ["Setting the Adapter Properties" on page 599](#) for more details.
5. The `close()` method is called to shut down the adapter. This gives you an opportunity to clean up and free resources used by the adapter.
6. This variant of the `IS2Adapter.authenticate()` method is called whenever an iSF client calls `AuthManager.authenticate()` with username and password parameters.
 

In this simple demonstration implementation, the `authenticate()` method recognizes only one user, `test_user`, with password, `test_password`.
7. This line calls a Log4J method in order to log a localized and parametrized message to indicate that the `authenticate` method has been called with the specified username and password values. Since

all the keys in the resource bundle begin with the adapter name, the adapter name is prepended to the key. The `l7dlog()` method is used because it automatically searches the resource bundle which was set previously by the `loggers setResourceBundle()` method.

8. If authentication is successful; that is, if the name and password passed in match `test_user` and `test_password`, the `getAuthorizationInfo()` method is called to obtain an `AuthenticatedPrincipal` object populated with *all* of the user's realms and role
9. If authentication fails, an `IS2AdapterException` is raised with minor code `IS2AdapterException.WRONG_NAME_PASSWORD`. The resource bundle is passed to the exception as it accesses the exception message from the bundle using the key, `ExampleAdapter.wrongUsernamePassword`.
10. This variant of the `IS2Adapter.authenticate()` method is called whenever an iSF client calls `AuthManager.authenticate()` with realm name, username and password parameters.  
This method differs from the preceding username/password `authenticate()` method in that only the authorization data for the specified realm and the global realm are included in the return value.
11. If authentication is successful, the `getAuthorizationInfo()` method is called to obtain an `AuthenticatedPrincipal` object populated with the authorization data from the specified realm and the global realm.
12. This variant of the `IS2Adapter.authenticate()` method is called whenever an iSF client calls `AuthManager.authenticate()` with an X.509 certificate parameter.
13. This variant of the `IS2Adapter.authenticate()` method is called whenever an iSF client calls `AuthManager.authenticate()` with a realm name and an X.509 certificate parameter.  
This method differs from the preceding certificate `authenticate()` method in that only the authorization data for the specified realm and the global realm are included in the return value.
14. This method should create an `AuthenticatedPrincipal` object for the username user. If a realm is *not* specified in the principal, the `AuthenticatedPrincipal` is populated with all realms and roles for this

- user. If a realm *is* specified in the principal, the `AuthenticatedPrincipal` is populated with authorization data from the specified realm and the global realm only.
15. This line creates a new `AuthenticatedPrincipal` object for the username `user` to hold the user's authorization data.
  16. This line adds a `GuestRole` role to the global realm, `IONAGlobalRealm`, using the single-argument form of `addRole()`. Roles added to the global realm implicitly belong to every named realm as well.
  17. This line checks if no realm is specified in the principal or if the realm, `EngRealm`, is specified. If either of these is true, the following lines add the authorization realm, `EngRealm`, to the `AuthenticatedPrincipal` object and add the `EngineerRole` role to the `EngRealm` authorization realm.
  18. This line checks if no realm is specified in the principal or if the realm, `FinanceRealm`, is specified. If either of these is true, the following lines add the authorization realm, `FinanceRealm`, to the `AuthenticatedPrincipal` object and add the `AccountantRole` role to the `FinanceRealm` authorization realm.
  19. Since SSO was introduced to Artix, this variant of the `IS2Adapter.getAuthorizationInfo()` method has been deprecated. The method `IS2Adapter.getAuthorizationInfo(AuthenticatedPrincipal principal)` should be used instead.
  20. Since SSO was introduced to Artix, this variant of the `IS2Adapter.getAuthorizationInfo()` method has also been deprecated. The method `IS2Adapter.getAuthorizationInfo(AuthenticatedPrincipal principal)` should be used instead.
  21. The `getAllUsers()` method is currently not used by the iSF server module during runtime. Hence, there is no need to implement this method currently.

22. When the `logout()` method is called, you can perform cleanup and release any resources associated with the specified user principal. The iSF server module calls back on `IS2Adapter.logout()` either in response to a user calling `AuthManager.logout()` explicitly or after an SSO session has timed out.

---

# Deploying the Adapter

---

**Overview**

---

This section explains how to deploy a custom iSF adapter.

---

**In this section**

This section contains the following subsections:

<a href="#">Configuring iSF to Load the Adapter</a>	<a href="#">page 598</a>
<a href="#">Setting the Adapter Properties</a>	<a href="#">page 599</a>
<a href="#">Loading the Adapter Class and Associated Resource Files</a>	<a href="#">page 600</a>

---

## Configuring iSF to Load the Adapter

---

### Overview

You can configure the iSF server module to load a custom adapter by setting the following properties in the iSF server module's `is2.properties` file:

- [Adapter name](#).
  - [Adapter class](#).
- 

### Adapter name

The iSF server module loads the adapter identified by the `com.iona.isp.adapters` property. Hence, to load a custom adapter, `AdapterName`, set the property as follows:

```
com.iona.isp.adapters=AdapterName
```

**Note:** In the current implementation, the iSF server module can load only a single adapter at a time.

---

### Adapter class

The name of the adapter class to be loaded is specified by the following property setting:

```
com.iona.isp.adapter.AdapterName.class=AdapterClass
```

---

### Example adapter

For example, the example adapter provided shown previously can be configured to load by setting the following properties:

```
com.iona.isp.adapters=example  
com.iona.isp.adapter.example.class=isfadapter.ExampleAdapter
```

---

## Setting the Adapter Properties

---

### Overview

This subsection explains how you can set properties for a specific custom adapter in the `is2.properties` file.

---

### Adapter property name format

All configurable properties for a custom file adapter, `AdapterName`, should have the following format:

```
com.iona.isp.adapter.AdapterName.param.PropertyName
```

---

### Truncation of property names

Adapter property names are truncated before being passed to the iSF adapter. That is, the `com.iona.isp.adapter.AdapterName.param` prefix is stripped from each property name.

---

### Example

For example, given an adapter named `ExampleAdapter` which has two properties, `host` and `port`, these properties would be set as follows in the `is2.properties` file:

```
com.iona.isp.adapter.example.param.example_property="This is an  
example property"
```

Before these properties are passed to the iSF adapter, the property names are truncated as if they had been set as follows:

```
example_property="This is an example property"
```

---

### Accessing properties from within an iSF adapter

The adapter properties are passed to the iSF adapter through the `com.iona.security.is2adapter.IS2Adapter.initialize()` callback method. For example:

```
...  
public void initialize(java.util.Properties props)  
throws IS2AdapterException {  
    // Access a property through its truncated name.  
    String propVal = props.getProperty("PropertyName")  
    ...  
}
```

---

## Loading the Adapter Class and Associated Resource Files

---

### Overview

You need to make appropriate modifications to your `CLASSPATH` to ensure that the iSF server module can find your custom adapter class. You need to distinguish between the following usages of the iSF server module:

- [CORBA service](#).
- [Java library](#)

In all cases, the location of the file used to configure Log4j logging can be set using the `log4j.configuration` property in the `is2.properties` file.

---

### CORBA service

By default, the Artix Security Service uses the `secure_artix.full_security.security_service` scope in your Orbix configuration file (or configuration repository service). Modify the `plugins:java_server:classpath` variable to include the directory containing the compiled adapter class and the adapter's resource bundle. The `plugins:java_server:classpath` variable uses the value of the `SECURITY_CLASSPATH` variable.

For example, if the adapter class and adapter resource bundle are located in the `ArtixInstallDir\ExampleAdapter` directory, you should set the `SECURITY_CLASSPATH` variable as follows:

```
# Artix configuration file
SECURITY_CLASSPATH =
  "ArtixInstallDir\ExampleAdapter;ArtixInstallDir\lib\corba\security_service\5.1\security_service-rt.jar";
```

### Java library

In this case, to make the custom iSF adapter class available to an iSF client, add the directory containing the compiled adapter class and adapter resource bundle to your `CLASSPATH`.

You must also specify the location of the license file, which can be set in one of the following ways:



- Uncomment and set the value of the `is2.license.filename` property in your domain's `is2.properties` file to point to license file for product. For example:

```
# iSF properties file
is2.license.filename=ArtixInstallDir/licenses.txt
```

- Add the license file to the `CLASSPATH` used for the iSF client.
- Pass the license file location to the iSF client using a Java system property:

```
java -DIT_LICENSE_FILE=LocationOfLicenseFile iSFClientClass
```

- Set the license in the code for the iSF client. For example:

```
// Java
...
SecurityService service = SecurityService.instance();
Properties props = new Properties();
props.load(new FileInputStream(propsFileName));
props.setProperty(
    SecurityService.IS2_LICENSE_FILE_NAME,
    LocationOfLicenseFile
);
service.initializeSecurity(props);
```



# Artix Security

*This appendix describes variables used by the IONA Security Framework. The Artix security infrastructure is highly configurable.*

## In this appendix

---

This appendix discusses the following topics:

<a href="#">Applying Constraints to Certificates</a>	page 605
<a href="#">bus:initial_contract</a>	page 607
<a href="#">bus:security</a>	page 608
<a href="#">initial_references</a>	page 610
<a href="#">password_retrieval_mechanism</a>	page 612
<a href="#">plugins:asp</a>	page 613
<a href="#">plugins:at_http</a>	page 616
<a href="#">plugins:atli2_tls</a>	page 621
<a href="#">plugins:csi</a>	page 622
<a href="#">plugins:csi</a>	page 622
<a href="#">plugins:gsp</a>	page 623
<a href="#">plugins:https</a>	page 628
<a href="#">plugins:iiop_tls</a>	page 629

<a href="#">plugins:java_server</a>	<a href="#">page 633</a>
<a href="#">plugins:kdm</a>	<a href="#">page 636</a>
<a href="#">plugins:kdm_adm</a>	<a href="#">page 638</a>
<a href="#">plugins:login_client</a>	<a href="#">page 639</a>
<a href="#">plugins:login_service</a>	<a href="#">page 640</a>
<a href="#">plugins:schannel</a>	<a href="#">page 641</a>
<a href="#">plugins:security</a>	<a href="#">page 642</a>
<a href="#">plugins:wSDL_publish</a>	<a href="#">page 645</a>
<a href="#">plugins:wss</a>	<a href="#">page 646</a>
<a href="#">policies</a>	<a href="#">page 648</a>
<a href="#">policies:asp</a>	<a href="#">page 655</a>
<a href="#">policies:bindings</a>	<a href="#">page 658</a>
<a href="#">policies:csi</a>	<a href="#">page 660</a>
<a href="#">policies:external_token_issuer</a>	<a href="#">page 663</a>
<a href="#">policies:https</a>	<a href="#">page 664</a>
<a href="#">policies:iioP_tls</a>	<a href="#">page 667</a>
<a href="#">policies:security_server</a>	<a href="#">page 677</a>
<a href="#">policies:soap:security</a>	<a href="#">page 679</a>
<a href="#">principal_sponsor</a>	<a href="#">page 680</a>
<a href="#">principal_sponsor:csi</a>	<a href="#">page 684</a>
<a href="#">principal_sponsor:http</a>	<a href="#">page 687</a>
<a href="#">principal_sponsor:https</a>	<a href="#">page 689</a>
<a href="#">principal_sponsor:iioP_tls</a>	<a href="#">page 691</a>
<a href="#">principal_sponsor:wsse</a>	<a href="#">page 693</a>

---

# Applying Constraints to Certificates

---

## Certificate constraints policy

You can use the `CertConstraintsPolicy` to apply constraints to peer X.509 certificates by the default `CertificateValidatorPolicy`. These conditions are applied to the owner's distinguished name (DN) on the first certificate (peer certificate) of the received certificate chain. Distinguished names are made up of a number of distinct fields, the most common being Organization Unit (OU) and Common Name (CN).

---

## Configuration variable

You can specify a list of constraints to be used by `CertConstraintsPolicy` through the `policies:iiop_tls:certificate_constraints_policy` or `policies:certificate_constraints_policy` configuration variables. For example:

```
policies:iiop_tls:certificate_constraints_policy =
    ["CN=Johnny*,OU=[unit1|IT_SSL],O=IONA,C=Ireland,ST=Dublin,L=Earth",
     "CN=Paul*,OU=SSLTEAM,O=IONA,C=Ireland,ST=Dublin,L=Earth",
     "CN=TheOmnipotentOne"];
```

---

## Constraint language

These are the special characters and their meanings in the constraint list:

*	Matches any text. For example: an* matches ant and anger, but not aunt
[ ]	Grouping symbols.
	Choice symbol. For example: OU=[unit1 IT_SSL] signifies that if the OU is unit1 or IT_SSL, the certificate is acceptable.
=, !=	Signify equality and inequality respectively.

---

## Example

This is an example list of constraints:

```
policies:iiop_tls:certificate_constraints_policy = [
    "OU=[unit1|IT_SSL],CN=Steve*,L=Dublin",
    "OU=IT_ART*,OU!=IT_ARTtesters,CN=[Jan|Donal],ST=
    Boston" ];
```

This constraint list specifies that a certificate is deemed acceptable if and only if it satisfies one or more of the constraint patterns:

```

If
  The OU is unit1 or IT_SSL
  And
  The CN begins with the text Steve
  And
  The location is Dublin
Then the certificate is acceptable
Else (moving on to the second constraint)
If
  The OU begins with the text IT_ART but isn't IT_ARTtesters
  And
  The common name is either Donal or Jan
  And
  The State is Boston
Then the certificate is acceptable
Otherwise the certificate is unacceptable.

```

The language is like a boolean OR, trying the constraints defined in each line until the certificate satisfies one of the constraints. Only if the certificate fails all constraints is the certificate deemed invalid.

Note that this setting can be sensitive about white space used within it. For example, "CN =" might not be recognized, where "CN=" is recognized.

---

## Distinguished names

For more information on distinguished names, see the *Security Guide*.

---

# bus:initial\_contract

The `bus:initial_contract` namespace contains the following configuration variable:

- [url:isf\\_service](#)
- [url:login\\_service](#)

---

## url:isf\_service

Specifies the location of the Artix security service's WSDL contract. This variable is needed by applications that connect to the Artix security service through a protocol specified in the physical part of the security service's WSDL contract (the alternative would be to connect over IIOP/TLS using a CORBA object reference).

This variable is used in conjunction with the `policies:asp:use_artix_proxies` configuration variable.

---

## url:login\_service

Specifies the location of the login service WSDL to the `login_client` plug-in. The value of this variable can either be a relative pathname or a URL. The `login_client` requires access to the login service WSDL in order to obtain details of the physical contract (for example, host and IP port).

---

# bus:security

The variables in the `bus:security` are intended for use with the `it_container_admin` utility, in order to facilitate communication with a secure Artix container. The `bus:security` namespace contains the following configuration variables:

- `enable_security`
- `user_name`
- `user_password`

---

## enable\_security

The `bus:security:enable_security` variable is a boolean variable that enables a client to send WSS username and password credentials. When `true`, the client sends WSS username and password credentials with every SOAP request message (whether or not the connection is secured by SSL/TLS); when `false`, the feature is disabled.

There are essentially two different ways of initializing the WSS username and password credentials on the client side:

- *From the Artix .cfg file*—you can set the WSS credentials in the Artix configuration using the related `user_name` and `user_password` configuration variables. For example:

```
# Artix .cfg file
bus:security:enable_security = "true";
bus:security:user_name = "Username";
bus:security:user_password = "Password";
```

- *From the command line*—if you omit the `bus:security:user_name` and `bus:security:user_password` settings from the Artix configuration, the client program will prompt you for the username and password credentials as it starts up. For example:

```
Please enter login :
Please enter password :
```



---

**user\_name**

Initializes a WSS username. This variable is intended for use in conjunction with the `bus:security:enable_security` variable as part of the configuration for the `it_container_admin` utility.

---

**user\_password**

Initializes a WSS password. This variable is intended for use in conjunction with the `bus:security:enable_security` variable as part of the configuration for the `it_container_admin` utility.

---

# initial\_references

The `initial_references` namespace contains the following configuration variables:

- [IT\\_SecurityService:reference](#)
- [IT\\_TLS\\_Toolkit:plugin](#)

---

## IT\_SecurityService:reference

This configuration variable specifies the location of the Artix security service. Clients of the security service need this configuration setting in order to locate and connect to the security service through the IIOP/TLS protocol.

**Note:** This variable is *not* relevant to clients that connect to a HTTPS-based security service.

The most convenient way to initialize this variable is to use a `corbaloc` URL. The `corbaloc` URL typically has the following format:

```
corbaloc:it_iops:1.2@Hostname:Port/IT_SecurityService
```

Where *Hostname* is the name of the host where the security service is running and *Port* is the IP port where the security service is listening for incoming connections.

If the security service is configured as a cluster, you need to use a multi-profile `corbaloc` URL, which lists the addresses of all the services in the cluster. For example, if you configure a cluster of three services—with addresses `security01:5001`, `security02:5002`, and `security03:5003`—you would set the `corbaloc` URL as follows:

```
corbaloc:it_iops:1.2@security01:5001,it_iops:1.2@security02:5002,it_iops:1.2@security03:5003/IT_SecurityService
```

---

## IT\_TLS\_Toolkit:plugin

This configuration variable enables you to specify the underlying SSL/TLS toolkit to be used by Artix. It is used in conjunction with the `plugins:baltimore_toolkit:shlib_name`, `plugins:schannel_toolkit:shlib_name` (Windows only) and `plugins:systemssl_toolkit:shlib_name` (z/OS only) configuration variables to implement SSL/TLS toolkit replaceability.

The default is the Baltimore toolkit.

For example, to specify that an application should use the Schannel SSL/TLS toolkit, you would set configuration variables as follows:

```
initial_references:IT_TLS_Toolkit:plugin = "schannel_toolkit";
plugins:schannel_toolkit:shlib_name = "it_tls_schannel";
```

---

# password\_retrieval\_mechanism

The configuration variables in the `password_retrieval_mechanism` namespace are intended to be used *only* by the Artix services. The following variables are defined in this namespace:

- `inherit_from_parent`
- `use_my_password_as_kdm_password`

---

## inherit\_from\_parent

If an application forks a child process and this variable is set to `true`, the child process inherits the parent's X.509 certificate password through the environment.

**Note:** This variable is intended for use *only* by the standard Artix services.

---

## use\_my\_password\_as\_kdm\_password

This variable should be set to `true` only in the scope of the KDM plug-in's container. From a security perspective it is dangerous to do otherwise as the password could be left in cleartext within the process.

The KDM is a locator plug-in and so it is natural that it should use the locator's identity as its identity. However, it requires a password to encrypt its security information. By default the KDM requests such a password from the user during locator startup and this is separate from the locator password. The locator password would be used if this variable is set to `true`.

**Note:** This variable is intended for use *only* by the standard Artix services.

---

# plugins:asp

The `plugins:asp` namespace contains the following variables:

- `authentication_cache_size`
- `authentication_cache_timeout`
- `authorization_realm`
- `default_password`
- `enable_security_service_cert_authentication`
- `enable_security_service_load_balancing`
- `security_type`
- `security_level`

---

## authentication\_cache\_size

The maximum number of credentials stored in the authentication cache. If this size is exceeded, any new authentication tokens acquired by calling the Artix security service are *not* stored in the cache. The cache can shrink again if some of the cached credentials expire (either because the individual token expiry time is exceeded or the `plugins:asp:authentication_cache_timeout` is exceeded).

A value of -1 (the default) means unlimited size. A value of 0 means disable the cache. The value must lie within the range -1 to  $2^{31}-1$ .

**Note:** This variable does not affect CORBA credentials. For details of how to configure the CORBA cache, see [“plugins:gsp” on page 623](#).

## authentication\_cache\_timeout

The time (in seconds) after which a credential expires. Expired credentials are removed from the cache and must re-authenticate with the Artix security service on the next call from that user.

A value of -1 means an infinite time-out. A value of 0 means disable the cache. The value must lie within the range -1 to  $2^{31}-1$ .

Default is 600 seconds.

**Note:** This variable does not affect CORBA credentials. For details of how to configure the CORBA cache, see [“plugins:gsp” on page 623](#).

---

## authorization\_realm

Specifies the Artix authorization realm to which an Artix server belongs. The value of this variable determines which of a user’s roles are considered when making an access control decision.

For example, consider a user that belongs to the `ejb-developer` and `corba-developer` roles within the `Engineering` realm, and to the `ordinary` role within the `Sales` realm. If you set `plugins:asp:authorization_realm` to `Sales` for a particular server, only the `ordinary` role is considered when making access control decisions (using the action-role mapping file).

The default is `IONAGlobalRealm`.

---

## default\_password

When the client credentials originate either from a CORBA Principal (embedded in a SOAP header) or from a certificate subject, the `default_password` variable specifies the password to use on the server side. The `plugins:asp:default_password` variable is used to get around the limitation that a `PRINCIPAL` identity and a `CERT_SUBJECT` are propagated without an accompanying password.

The `artix_security` plug-in uses the received client principal together with the password specified by `plugins:asp:default_password` to authenticate the user through the Artix security service.

The default value is the string, `default_password`.

---

## enable\_security\_service\_cert\_authentication

When this parameter is set to `true`, the client certificate is retrieved from the TLS connection. If no other credentials are available, the client certificate is then sent to the Artix security service for authentication.

The client certificate has the lowest precedence for authentication. Hence, if any other credentials are presented by the client (for example, if the client sends a WSS username and password), these alternative credentials are sent to the Artix security service instead of the certificate credentials.

Default is `false`.

---

## enable\_security\_service\_load\_balancing

A boolean variable that enables load balancing over a cluster of security services. If an application is deployed in a domain that uses security service clustering, the application should be configured to use *client load balancing* (in this context, *client* means a client of the Artix security service). See also `policies:iiop_tls:load_balancing_mechanism`.

Default is `false`.

---

## security\_type

*(Obsolete)* From Artix 3.0 onwards, this variable is ignored.

---

## security\_level

Specifies the level from which security credentials are picked up. The following options are supported by the `artix_security` plug-in:

- |                            |                                                                          |
|----------------------------|--------------------------------------------------------------------------|
| <code>MESSAGE_LEVEL</code> | Get security information from the transport header. This is the default. |
| <code>REQUEST_LEVEL</code> | Get the security information from the message header.                    |

---

## plugins:at\_http

The `plugins:at_http` configuration variables are provided to facilitate migration from legacy Artix applications (that is, Artix releases prior to version 3.0). The `plugins:at_http` namespace contains variables that are similar to the variables from the old (pre-version 3.0) `plugins:http` namespace. One important change made in 3.0, however, is that an application's own certificate must now be provided in PKCS#12 format (where they were previously supplied in PEM format).

If the variables from the `plugins:at_http` namespace are used, they take precedence over the analogous variables from the `principal_sponsor:https` and `policies:https` namespaces.

The `plugins:at_http` namespace contains the following variables:

- `client:client_certificate`.
- `client:client_private_key_password`.
- `client:trusted_root_certificates`.
- `client:use_secure_sockets`.
- `server:server_certificate`.
- `server:server_private_key_password`.
- `server:trusted_root_certificates`.
- `server:use_secure_sockets`.

---

### client:client\_certificate

This variable specifies the full path to the PKCS#12-encoded X.509 certificate issued by the certificate authority for the client. For example:

```
plugins:at_http:client:client_certificate =  
    "C:\aspen\x509\certs\key.cert.p12"
```

---

### client:client\_private\_key\_password

This variable specifies the password to decrypt the contents of the PKCS#12 certificate file specified by `client:client_certificate`.



---

## client:trusted\_root\_certificates

This variable specifies the path to a file containing a concatenated list of CA certificates in PEM format. The client uses this CA list during the TLS handshake to verify that the server's certificate has been signed by a trusted CA.

---

## client:use\_secure\_sockets

The effect of the `client:use_secure_sockets` variable depends on the type of URL specifying the remote service location:

- `https://host:port` URL format—the client always attempts to open a secure connection. That is, the value of `plugins:at_http:client:use_secure_sockets` is effectively ignored.
- `http://host:port` URL format—whether the client attempts to open a secure connection or not depends on the value of `plugins:at_http:client:use_secure_sockets`, as follows:
  - ◆ `true`—the client attempts to open a secure connection (that is, HTTPS running over SSL or TLS). If no port is specified in the `http` URL, the client uses port 443 for secure HTTPS.
  - ◆ `false`—the client attempts to open an insecure connection (that is, plain HTTP).

If `plugins:at_http:client:use_secure_sockets` is true and the client decides to open a secure connection, the `at_http` plug-in then automatically loads the `https` plug-in.

**Note:** If `plugins:at_http:client:use_secure_sockets` is true and the client decides to open a secure connection, Artix uses the following client secure invocation policies by default:

```

policies:client_secure_invocation_policy:requires =
["Confidentiality", "Integrity", "DetectReplay",
"DetectMisordering", "EstablishTrustInTarget"];

policies:client_secure_invocation_policy:supports =
["Confidentiality", "Integrity", "DetectReplay",
"DetectMisordering", "EstablishTrustInTarget",
"EstablishTrustInClient"];

```

You can optionally override these defaults by setting the client secure invocation policy explicitly in configuration.

---

## server:server\_certificate

This variable specifies the full path to the PKCS#12-encoded X.509 certificate issued by the certificate authority for the server. For example:

```

plugins:at_http:server:server_certificate =
"c:\aspen\x509\certs\key.cert.p12"

```

---

## server:server\_private\_key\_password

This variable specifies the password to decrypt the contents of the PKCS#12 certificate file specified by `server:server_certificate`.

---

## server:trusted\_root\_certificates

This variable specifies the path to a file containing a concatenated list of CA certificates in PEM format. The server uses this CA list during the TLS handshake to verify that the client's certificate has been signed by a trusted CA.

---

## server:use\_secure\_sockets

The effect of the `server:use_secure_sockets` variable depends on the type of URL advertising the service location:

- `https://host:port` URL format—the server accepts only secure connection attempts. That is, the value of `plugins:at_http:server:use_secure_sockets` is effectively ignored.
- `http://host:port` URL format—whether the server accepts secure connection attempts or not depends on the value of `plugins:at_http:server:use_secure_sockets`, as follows:
  - ◆ `true`—the server accepts secure connection attempts (that is, HTTPS running over SSL or TLS). If no port is specified in the `http` URL, the server uses port 443 for secure HTTPS.
  - ◆ `false`—the server accepts insecure connection attempts (that is, plain HTTP).

If `plugins:at_http:server:use_secure_sockets` is set and the server accepts a secure connection, the `at_http` plug-in then automatically loads the `https` plug-in.

**Note:** If `plugins:at_http:server:use_secure_sockets` is set and the server accepts a secure connection, Artix uses the following server secure invocation policies by default:

```
    policies:target_secure_invocation_policy:requires =
["Confidentiality", "Integrity", "DetectReplay",
"DetectMisordering", "EstablishTrustInClient"];

    policies:target_secure_invocation_policy:supports =
["Confidentiality", "Integrity", "DetectReplay",
"DetectMisordering", "EstablishTrustInTarget",
"EstablishTrustInClient"];
```

You can optionally override these defaults by setting the target secure invocation policy explicitly in configuration.

## **server:use\_secure\_sockets:container**

The effect of the `server:use_secure_sockets:container` variable is similar to the effect of the `server:use_secure_sockets` variable, except that only the `ContainerService` service is affected. Using this variable, it is possible to enable HTTPS security specifically for the `ContainerService` service without affecting the security settings of other services deployed in the container.

---

## plugins:atli2\_tls

The `plugins:atli2_tls` namespace contains the following variable:

- `use_jsse_tk`

---

### use\_jsse\_tk

(Java only) Specifies whether or not to use the JSSE/JCE architecture with the CORBA binding. If `true`, the CORBA binding uses the JSSE/JCE architecture to implement SSL/TLS security; if `false`, the CORBA binding uses the Baltimore SSL/TLS toolkit.

The default is `false`.

---

# plugins:csi

The `policies:csi` namespace includes variables that specify settings for Common Secure Interoperability version 2 (CSIv2):

- `ClassName`
- `shlib_name`

---

## ClassName

`ClassName` specifies the Java class that implements the `csi` plugin. The default setting is:

```
plugins:csi:ClassName = "com.iona.corba.security.csi.CSIPlugin";
```

This configuration setting makes it possible for the Artix core to load the plugin on demand. Internally, the Artix core uses a Java class loader to load and instantiate the `csi` class. Plugin loading can be initiated either by including the `csi` in the `orb_plugins` list, or by associating the plugin with an initial reference.

---

## shlib\_name

`shlib_name` identifies the shared library (or DLL in Windows) containing the `csi` plugin implementation.

```
plugins:csi:shlib_name = "it_csi_prot";
```

The `csi` plug-in becomes associated with the `it_csi_prot` shared library, where `it_csi_prot` is the base name of the library. The library base name, `it_csi_prot`, is expanded in a platform-dependent manner to obtain the full name of the library file.

---

# plugins:gsp

The `plugins:gsp` namespace includes variables that specify settings for the Generic Security Plugin (GSP). This provides authorization by checking a user's roles against the permissions stored in an action-role mapping file. It includes the following:

- `accept_asserted_authorization_info`
- `action_role_mapping_file`
- `assert_authorization_info`
- `authentication_cache_size`
- `authentication_cache_timeout`
- `authorization_realm`
- `ClassName`
- `enable_authorization`
- `enable_gssup_sso`
- `enable_user_id_logging`
- `enable_x509_sso`
- `enforce_secure_comms_to_sso_server`
- `enable_security_service_cert_authentication`
- `sso_server_certificate_constraints`
- `use_client_load_balancing`

---

## accept\_asserted\_authorization\_info

If `false`, SAML authorization data is not read from incoming connections.

**Note:** In Artix versions 4.0 and earlier, if no SAML authorization data is received and this variable is `true`, Artix would raise an exception. In Artix versions 4.1 and later, if no SAML authorization data is retrieved, Artix re-authenticates the client credentials with the security service, irrespective of whether the `accept_asserted_authorization_info` variable is `true` or `false`.

Default is `true`.

---

## action\_role\_mapping\_file

Specifies the action-role mapping file URL. For example:

```
plugins:gsp:action_role_mapping_file =  
    "file:///my/action/role/mapping";
```

---

## assert\_authorization\_info

If `false`, SAML authorization data is not sent on outgoing connections. Default is `true`.

---

## authentication\_cache\_size

The maximum number of credentials stored in the authentication cache. If this size is exceeded the oldest credential in the cache is removed.

A value of -1 (the default) means unlimited size. A value of 0 means disable the cache.

---

## authentication\_cache\_timeout

The time (in seconds) after which a credential is considered *stale*. Stale credentials are removed from the cache and the server must re-authenticate with the Artix security service on the next call from that user. The cache timeout should be configured to be smaller than the timeout set in the `is2.properties` file (by default, that setting is `is2.sso.session.timeout=600`).

A value of -1 (the default) means an infinite time-out. A value of 0 means disable the cache.

---

## authorization\_realm

`authorization_realm` specifies the iSF authorization realm to which a server belongs. The value of this variable determines which of a user's roles are considered when making an access control decision.



For example, consider a user that belongs to the `ejb-developer` and `corba-developer` roles within the `Engineering` realm, and to the ordinary role within the `Sales` realm. If you set `plugins:gsp:authorization_realm` to `Sales` for a particular server, only the ordinary role is considered when making access control decisions (using the `action-role` mapping file).

---

## ClassName

`ClassName` specifies the Java class that implements the `gsp` plugin. This configuration setting makes it possible for the Artix core to load the plugin on demand. Internally, the Artix core uses a Java class loader to load and instantiate the `gsp` class. Plugin loading can be initiated either by including the `csi` in the `orb_plugins` list, or by associating the plugin with an initial reference.

---

## enable\_authorization

A boolean GSP policy that, when `true`, enables authorization using action-role mapping ACLs in server.

Default is `true`.

---

## enable\_gssup\_sso

Enables SSO with a username and a password (that is, GSSUP) when set to `true`.

---

## enable\_user\_id\_logging

A boolean variable that enables logging of user IDs on the server side. Default is `false`.

Up until the release of Orbix 6.1 SP1, the GSP plug-in would log messages containing user IDs. For example:

```
[junit] Fri, 28 May 2004 12:17:22.000000 [SLEEPY:3284]
(IT_CSI:205) I - User alice authenticated successfully.
```

In some cases, however, it might not be appropriate to expose user IDs in the Orbix log. From Orbix 6.2 onward, the default behavior of the GSP plug-in is changed, so that user IDs are *not* logged by default. To restore the pre-Orbix 6.2 behavior and log user IDs, set this variable to `true`.

---

## enable\_x509\_sso

Enables certificate-based SSO when set to `true`.

---

## enforce\_secure\_comms\_to\_sso\_server

Enforces a secure SSL/TLS link between a client and the login service when set to `true`. When this setting is true, the value of the SSL/TLS client secure invocation policy does *not* affect the connection between the client and the login service.

Default is `true`.

---

## enable\_security\_service\_cert\_authentication

A boolean GSP policy that enables X.509 certificate-based authentication on the server side using the Artix security service.

Default is `false`.

---

## sso\_server\_certificate\_constraints

A special certificate constraints policy that applies *only* to the SSL/TLS connection between the client and the SSO login server. For details of the pattern constraint language, see [“Applying Constraints to Certificates” on page 605](#).

---

## use\_client\_load\_balancing

A boolean variable that enables load balancing over a cluster of security services. If an application is deployed in a domain that uses security service clustering, the application should be configured to use *client load balancing* (in this context, *client* means a client of the Artix security service). See also `policies:iiop_tls:load_balancing_mechanism`.

Default is `true`.

---

# plugins:https

The `plugins:https` namespace contains the following variable:

- [ClassName](#)

---

## ClassName

(Java only) This variable specifies the class name of the `https` plug-in implementation. For example:

```
plugins:https:ClassName = "com.ionacorba.https.HTTPSPlugIn";
```

---

## plugins:iiop\_tls

The `plugins:iiop_tls` namespace contains the following variables:

- `buffer_pool:recycle_segments`
- `buffer_pool:segment_preallocation`
- `buffer_pools:max_incoming_buffers_in_pool`
- `buffer_pools:max_outgoing_buffers_in_pool`
- `delay_credential_gathering_until_handshake`
- `enable_iiop_1_0_client_support`
- `incoming_connections:hard_limit`
- `incoming_connections:soft_limit`
- `outgoing_connections:hard_limit`
- `outgoing_connections:soft_limit`
- `tcp_listener:reincarnate_attempts`
- `tcp_listener:reincarnation_retry_backoff_ratio`
- `tcp_listener:reincarnation_retry_delay`

---

### buffer\_pool:recycle\_segments

(Java only) When this variable is set, the `iiop_tls` plug-in reads this variable's value instead of the `plugins:iiop:buffer_pool:recycle_segments` variable's value.

---

### buffer\_pool:segment\_preallocation

(Java only) When this variable is set, the `iiop_tls` plug-in reads this variable's value instead of the `plugins:iiop:buffer_pool:segment_preallocation` variable's value.

## **buffer\_pools:max\_incoming\_buffers\_in\_pool**

(C++ only) When this variable is set, the `iiop_tls` plug-in reads this variable's value instead of the `plugins:iiop:buffer_pools:max_incoming_buffers_in_pool` variable's value.

---

## **buffer\_pools:max\_outgoing\_buffers\_in\_pool**

(C++ only) When this variable is set, the `iiop_tls` plug-in reads this variable's value instead of the `plugins:iiop:buffer_pools:max_outgoing_buffers_in_pool` variable's value.

---

## **delay\_credential\_gathering\_until\_handshake**

(Windows and Schannel only) This client configuration variable provides an alternative to using the `principal_sponsor` variables to specify an application's own certificate. When this variable is set to `true` and `principal_sponsor:use_principal_sponsor` is set to `false`, the client delays sending its certificate to a server. The client will wait until the server *explicitly* requests the client to send its credentials during the SSL/TLS handshake.

This configuration variable can be used in conjunction with the `plugins:schannel:prompt_with_credential_choice` configuration variable.

---

## **enable\_iiop\_1\_0\_client\_support**

This variable enables client-side interoperability of Artix SSL/TLS applications with legacy IIOP 1.0 SSL/TLS servers, which do not support IIOP 1.1.

The default value is `false`. When set to `true`, Artix SSL/TLS searches secure target IIOp 1.0 object references for legacy IIOp 1.0 SSL/TLS tagged component data, and attempts to connect on the specified port.

**Note:** This variable will not be necessary for most users.

---

### **incoming\_connections:hard\_limit**

Specifies the maximum number of incoming (server-side) connections permitted to IIOp. IIOp does not accept new connections above this limit. Defaults to -1 (disabled).

When this variable is set, the `iiop_tls` plug-in reads this variable's value instead of the `plugins:iiop:incoming_connections:hard_limit` variable's value.

Please see the chapter on ACM in the *CORBA Programmer's Guide* for further details.

---

### **incoming\_connections:soft\_limit**

Specifies the number of connections at which IIOp should begin closing incoming (server-side) connections. Defaults to -1 (disabled).

When this variable is set, the `iiop_tls` plug-in reads this variable's value instead of the `plugins:iiop:incoming_connections:soft_limit` variable's value.

Please see the chapter on ACM in the *CORBA Programmer's Guide* for further details.

---

### **outgoing\_connections:hard\_limit**

When this variable is set, the `iiop_tls` plug-in reads this variable's value instead of the `plugins:iiop:outgoing_connections:hard_limit` variable's value.

---

## outgoing\_connections:soft\_limit

When this variable is set, the `iiop_tls` plug-in reads this variable's value instead of the `plugins:iiop:outgoing_connections:soft_limit` variable's value.

---

## tcp\_listener:reincarnate\_attempts

(Windows only)

`plugins:iiop_tls:tcp_listener:reincarnate_attempts` specifies the number of times that a Listener recreates its listener socket after receiving a `SocketException`.

Sometimes a network error may occur, which results in a listening socket being closed. On Windows, you can configure the listener to attempt a reincarnation, which enables new connections to be established. This variable only affects Java and C++ applications on Windows. Defaults to 0 (no attempts).

---

## tcp\_listener:reincarnation\_retry\_backoff\_ratio

(Windows only)

`plugins:iiop_tls:tcp_listener:reincarnation_retry_delay` specifies a delay between reincarnation attempts. Data type is `long`. Defaults to 0 (no delay).

---

## tcp\_listener:reincarnation\_retry\_delay

(Windows only)

`plugins:iiop_tls:tcp_listener:reincarnation_retry_backoff_ratio` specifies the degree to which delays between retries increase from one retry to the next. Datatype is `long`. Defaults to 1.



---

## plugins:java\_server

In the context of Artix security, the variables in the `plugins:java_server` namespace are used only to configure the Artix security service. To deploy the security service, Artix exploits IONA's *generic server* (which is a feature originally developed for Orbix). The Artix security service is deployed into the following container hierarchy:

- *Generic server*—a simple container, originally developed for the Orbix product, which enables you to deploy CORBA services implemented in C++.
- *Java server plug-in*—a JNI-based adapter that plugs into the generic server, enabling you to deploy CORBA services implemented in Java.
- *JVM created by the Java server plug-in*—once it is loaded, the Java server plug-in creates a JVM instance to host a Java program.
- *Artix security service Java code*—you instruct the Java server plug-in to load the security service core (which is implemented in Java) by specifying the appropriate class to the `plugins:java_server:class` variable.

In addition to the configuration variables described in this section, you must also include the following setting in your configuration:

```
generic_server_plugin = "java_server";
```

Which instructs the generic server to load the Java server plug-in.

The `plugins:java_server` namespace contains the following variables:

- [class](#)
- [classpath](#)
- [jni\\_verbose](#)
- [shlib\\_name](#)
- [system\\_properties](#)
- [X\\_options](#)

---

## class

In the context of the Artix security service, this variable specifies the entry point to the core security service (the core security service is a pure Java program). There are two possible values:

- `com.iona.jbus.security.services.SecurityServer`—creates an Artix bus instance that takes its configuration from the `bus` sub-scope of the current configuration scope. This entry point is suitable for a security service that is accessed through a WSDL contract (for example, a HTTPS-based security service).
- `com.iona.corba.security.services.SecurityServer`—a CORBA-based implementation of the security service, which does *not* create an Artix bus instance. This entry point is suitable for running an IIOP/TLS-based security service.

---

## classpath

Specifies the `CLASSPATH` for the JVM instance created by the Java server plug-in. For the Artix security service, this `CLASSPATH` must point at the JAR file containing the implementation of the security service. For example:

```
plugins:java_server:classpath =
  "C:\artix_40/lib/artix/security_service/4.0/security_service-rt.jar";
```

The Java server plug-in ignores the contents of the `CLASSPATH` environment variable.

---

## jni\_verbose

A boolean variable that instructs the JVM to output JNI-level diagnostics, which can be helpful for troubleshooting. When `true`, the JVM-generated diagnostic messages are sent to the Artix logging stream; when `false`, the diagnostic messages are suppressed.

---

## shlib\_name

Specifies the abbreviated name of the shared library that implements the `java_server` plug-in. This variable must always be set as follows:

```
plugins:java_server:shlib_name = "it_java_server";
```

---

## system\_properties

Specifies a list of Java system properties to the JVM created by the Java server plug-in. For example, the Artix security service requires the following Java system property settings:

```
plugins:java_server:system_properties =
  ["org.omg.CORBA.ORBClass=com.ion.corba.art.artimpl.ORBImpl",
   "org.omg.CORBA.ORBSingletonClass=com.ion.corba.art.artimpl.ORBSingleton",
   "is2.properties=%{INSTALL_DIR}/%{PRODUCT_NAME}/%{PRODUCT_VERSION}/demos/security/full_security/etc/is2.properties.FILE",
   "java.endorsed.dirs=%{INSTALL_DIR}/%{PRODUCT_NAME}/%{PRODUCT_VERSION}/lib/endorsed"];
```

Where each item in the list specifies a Java system property, as follows:

```
<PropertyName>=<PropertyValue>
```

---

## X\_options

Specifies a list of non-standard, `-x`, options to the JVM created by the Java server plug-in. In contrast to the way these options are specified to the `java` command-line tool, you must omit the `-x` prefix in the `X_options` list.

For example:

```
plugins:java_server:X_options = ["rs"];
```

To find out more about the non-standard JVM options, type `java -x -help` at the command line (using Sun's implementation of the JVM).

---

## plugins:kdm

The `plugins:kdm` namespace contains the following variables:

- `cert_constraints`
- `iiop_tls:port`
- `checksums_optional`

---

### cert\_constraints

Specifies the list of certificate constraints for principals attempting to open a connection to the KDM server plug-in. See [“Applying Constraints to Certificates” on page 605](#) for a description of the certificate constraint syntax.

To protect the sensitive data stored within it, the KDM applies restrictions on which entities are allowed talk to it. A security administrator should choose certificate constraints that restrict access to the following principals:

- The locator service (requires read-only access).
- The `kdm_admin` plug-in, which is normally loaded into the `itadmin` utility (requires read-write access).

All other principals should be blocked from access. For example, you might define certificate constraints similar to the following:

```
plugins:kdm:cert_constraints =  
    ["C=US,ST=Massachusetts,O=ABigBank*,CN=Secure admin*",  
     "C=US,ST=Boston,O=ABigBank*,CN=Orbix2000 Locator Service*"]
```

Your choice of certificate constraints will depend on the naming scheme for your subject names.

---

**iiop\_tls:port**

Specifies the well known IP port on which the KDM server listens for incoming calls.

---

**checksums\_optional**

When equal to `false`, the secure information associated with a server must include a checksum; when equal to `true`, the presence of a checksum is optional. Default is `false`.

---

## plugins:kdm\_adm

The `plugins:kdm_adm` namespace contains the following variable:

- [cert\\_constraints](#)

---

### cert\_constraints

Specifies the list of certificate constraints that are applied when the KDM administration plug-in authenticates the KDM server. See [“Applying Constraints to Certificates” on page 605](#) for a description of the certificate constraint syntax.

The KDM administration plug-in requires protection against attack from applications that try to impersonate the KDM server. A security administrator should, therefore, choose certificate constraints that restrict access to trusted KDM servers only. For example, you might define certificate constraints similar to the following:

```
plugins:kdm_adm:cert_constraints =  
    ["C=US,ST=Massachusetts,O=ABigBank*,CN=IT_KDM*"];
```

Your choice of certificate constraints will depend on the naming scheme for your subject names.

---

# plugins:login\_client

The `plugins:login_client` namespace contains the following variables:

- `wsdl_url`

---

## `wsdl_url`

*(Deprecated)* Use `bus:initial_contract:url:login_service` instead.

---

## plugins:login\_service

The `plugins:login_service` namespace contains the following variables:

- `wsdl_url`

---

### **wsdl\_url**

Specifies the location of the login service WSDL to the `login_service` plug-in. The value of this variable can either be a relative pathname or an URL. The `login_service` requires access to the login service WSDL in order to obtain details of the physical contract (for example, host and IP port).



---

# plugins:schannel

The `plugins:schannel` namespace contains the following variable:

- [prompt\\_with\\_credential\\_choice](#)

---

## prompt\_with\_credential\_choice

(Windows and Schannel only) Setting both this variable and the `plugins:iiop_tls:delay_credential_gathering_until_handshake` variable to `true` on the client side allows the user to choose which credentials to use for the server connection. The choice of credentials offered to the user is based on the trusted CAs sent to the client in an SSL/TLS handshake message.

If `prompt_with_credential_choice` is set to `false`, runtime chooses the first certificate it finds in the certificate store that meets the applicable constraints.

The certificate prompt can be replaced by implementing an IDL interface and registering it with the ORB.

---

# plugins:security

The `plugins:security` namespace contains the following variable:

- `direct_persistence`
  - `iiop_tls:addr_list`
  - `iiop_tls:host`
  - `iiop_tls:port`
  - `log4j_to_local_log_stream`
  - `share_credentials_across_orbs`
- 

## direct\_persistence

A boolean variable that specifies whether or not the security service runs on a fixed IP port (for an IIOP/TLS-based security service). You must always set this variable to `true` in the security service's configuration scope, because the security service *must* run on a fixed port.

---

## iiop\_tls:addr\_list

When the security service is configured as a cluster, you must use this variable to list the addresses of all of the security services in the cluster.

The first entry, *not* prefixed by a `+` sign, must specify the address of the current security service instance. The remaining entries, prefixed by a `+` sign, must specify the addresses of the other services in the cluster (the `+` sign indicates that an entry affects only the contents of the generated IOR, not the security service's listening port).

For example, to configure the first instance of a cluster consisting of three security service instances—with addresses `security01:5001`, `security02:5002`, and `security03:5003`—you would initialize the address list as follows:

```
plugins:security:iiop_tls:addr_list = ["security01:5001",  
    "+security02:5002", "+security03:5003"];
```

---

## iiop\_tls:host

Specifies the hostname where the security service is running. This hostname will be embedded in the security service's IOR (for an IIOP/TLS-based security service).

---

## iiop\_tls:port

Specifies the fixed IP port where the security service listens for incoming connections. This IP port also gets embedded in the security service's IOR (for an IIOP/TLS-based security service).

---

## log4j\_to\_local\_log\_stream

Redirects the Artix security service's log4j output to the local log stream. In the Artix security service's configuration scope, you can set the `plugins:security:log4j_to_local_log_stream` variable to one of the following values:

- `true`—the security service log4j output is sent to the local log stream. This requires that the `local_log_stream` plug-in is present in the `orb_plugins` list.
- `false`—(*default*) the log4j output is controlled by the `log4j.properties` file (whose location is specified in the `is2.properties` file).

When redirecting log4j messages to the local log stream, you can control the log4j logging level using Artix event log filters. You can specify Artix event log filters with the following setting in the Artix `.cfg` file:

```
event_log:filters = ["IT_SECURITY=LoggingLevels"];
```

The `IT_SECURITY` tag configures the logging levels for the Artix security service (which includes the redirected log4j stream). log4j has five logging levels: `DEBUG`, `INFO`, `WARN`, `ERROR`, and `FATAL`. To select a particular log4j logging level (for example, `WARN`), replace `LoggingLevels` by that logging level plus all of the higher logging levels (for example, `WARN+ERROR+FATAL`).

For example, you can configure the Artix security service to send log4j logging to the local log stream, as follows:

```
# Artix .cfg file
security_service
{
    orb_plugins = ["local_log_stream", "iiop_profile", "giop",
"iiop_tls"];
    plugins:security:log4j_to_local_log_stream = "true";

    # Log all log4j messages at level WARN and above
    event_log:filters = ["IT_SECURITY=WARN+ERROR+FATAL"];
    ...
};
```

---

## share\_credentials\_across\_orbs

Enables own security credentials to be shared across ORBs. Normally, when you specify an own SSL/TLS credential (using the principal sponsor or the principal authenticator), the credential is available only to the ORB that created it. By setting the

`plugins:security:share_credentials_across_orbs` variable to `true`, however, the own SSL/TLS credentials created by one ORB are automatically made available to any other ORBs that are configured to share credentials.

See also `principal_sponsor:csi:use_existing_credentials` for details of how to enable sharing of CSI credentials.

Default is `false`.

---

# plugins:wSDL\_publish

The `plugins:wSDL_publish` namespace contains the following variables:

- `enable_secure_wSDL_publish`

---

## enable\_secure\_wSDL\_publish

A boolean variable that enables certain security features of the WSDL publishing service that are required whenever the WSDL publishing service is configured to use the HTTPS protocol. Set this variable to `true`, if the WSDL publishing service is configured to use HTTPS; otherwise, set it to `false`.

Default is `false`.

For example, to configure the WSDL publishing service to use HTTPS, you should include the following in your program's configuration scope:

```
# Artix .cfg file
secure_server
{
    orb_plugins = [ ... , "wSDL_publish", "at_http", "https"];

    plugins:wSDL_publish:publish_port = "2222";
    plugins:wSDL_publish:enable_secure_wSDL_publish = "true";
    plugins:at_http:server:use_secure_sockets = "true";

    # Other HTTPS-related settings
    ...
};
```

The `plugins:at_http:server:use_secure_sockets` setting is needed to enable HTTPS for the WSDL publishing service.

**Note:** You must set *both* `plugins:wSDL_publish:enable_secure_wSDL_publish` and `plugins:at_http:server:use_secure_sockets` to `true`, when enabling HTTPS for the WSDL publish plug-in.

---

# plugins:wss

The `plugins:wss` namespace defines variables that are needed to configure the Artix partial message protection feature. Partial message protection is a WS-Security feature that enables you to apply cryptographic operations at the SOAP 1.1 binding level, including encrypting and signing a message's SOAP body. The variables belonging to this namespace are as follows:

- `classname`
- `keyretrieval:keystore:file`
- `keyretrieval:keystore:provider`
- `keyretrieval:keystore:storepass`
- `keyretrieval:keystore:storetype`
- `protection_policy:location`

---

## classname

Specifies the name of the Java class that implements the WSS plug-in. This variable must be set to the value

```
com.iona.jbus.security.wss.plugin.BusPlugInFactory.
```

---

## keyretrieval:keystore:file

Specifies the location of a Java keystore file. This must be a filename or file pathname, not a URL.

---

## keyretrieval:keystore:provider

Specifies the name of the Java keystore provider (*optional*). Using the Java cryptographic extension (JCE) package from Sun, it is possible to provide a custom implementation of the Java keystore. If your Java keystore is based on a custom provider, use this variable to set the *provider name*.

Default is to use the default provider provided by the Java virtual machine.

---

## keyretrieval:keystore:storepass

Specifies the password to access the Java keystore. This variable is used in conjunction with `plugins:wss:keyretrieval:keystore:file` to associate a Java keystore with the WSS plug-in.

For example:

```
# Artix .cfg file
plugins:wss:keyretrieval:keystore:file="Keystore.jks";
plugins:wss:keyretrieval:keystore:storepass="StorePassword";
plugins:wss:keyretrieval:keystore:provider="";
plugins:wss:keyretrieval:keystore:storetype="";
```

---

## keyretrieval:keystore:storetype

Specifies the type of the Java keystore (*optional*). Using the Java cryptographic extension (JCE) package from Sun, it is possible to provide a custom implementation of the Java keystore. If your Java keystore is based on a custom provider, use this variable to set the keystore type.

Default is `jks`.

---

## protection\_policy:location

Specifies the location of a policy configuration file that governs the behavior of the partial message protection feature. The policy configuration file is an XML file that conforms to the `protection-policy.xsd` XML schema (located in `ArtixInstallDir/cxx_java/schemas`).

---

# policies

The `policies` namespace defines the default CORBA policies for an ORB. Many of these policies can also be set programmatically from within an application. SSL/TLS-specific variables in the `policies` namespace include:

- `allow_unauthenticated_clients_policy`
- `certificate_constraints_policy`
- `client_secure_invocation_policy:requires`
- `client_secure_invocation_policy:supports`
- `max_chain_length_policy`
- `mechanism_policy:accept_v2_hellos`
- `mechanism_policy:ciphersuites`
- `mechanism_policy:protocol_version`
- `session_caching_policy`
- `target_secure_invocation_policy:requires`
- `target_secure_invocation_policy:supports`
- `trusted_ca_list_policy`

---

## allow\_unauthenticated\_clients\_policy

A generic variable that sets this policy both for `iiop_tls` and `https`. To set this policy specifically for the IIOP/TLS protocol, set the `policies:iiop_tls:allow_unauthenticated_clients_policy` variable, which takes precedence.

A boolean variable that specifies whether a server will allow a client to establish a secure connection without sending a certificate. Default is `false`. This configuration variable is applicable *only* in the special case where the target secure invocation policy is set to require `NoProtection` (a semi-secure server).



---

## certificate\_constraints\_policy

A generic variable that sets this policy both for `iiop_tls` and `https`. To set this policy specifically for the IOP/TLS protocol, set the `policies:iiop_tls:certificate_constraints_policy` variable, which takes precedence.

A list of constraints applied to peer certificates—see [“Applying Constraints to Certificates” on page 605](#). If a peer certificate fails to match any of the constraints, the certificate validation step will fail.

The policy can also be set programmatically using the `IT_TLS_API::CertConstraintsPolicy` CORBA policy. Default is no constraints.

---

## client\_secure\_invocation\_policy:requires

A generic variable that sets this policy both for `iiop_tls` and `https`. To set this policy specifically for the IOP/TLS protocol, set the `policies:iiop_tls:client_secure_invocation_policy:requires` variable, which takes precedence.

Specifies the minimum level of security required by a client. The value of this variable is specified as a list of association options—see the *Artix Security Guide* for more details about association options.

In accordance with CORBA security, this policy cannot be downgraded programmatically by the application.

---

## client\_secure\_invocation\_policy:supports

A generic variable that sets this policy both for `iiop_tls` and `https`. To set this policy specifically for the IIOp/TLS protocol, set the `policies:iiop_tls:client_secure_invocation_policy:supports` variable, which takes precedence.

Specifies the initial maximum level of security supported by a client. The value of this variable is specified as a list of association options—see the *Artix Security Guide* for more details about association options.

This policy can be upgraded programmatically using either the `QOP` or the `EstablishTrust` policies.

---

## max\_chain\_length\_policy

A generic variable that sets this policy both for `iiop_tls` and `https`. To set this policy specifically for the IIOp/TLS protocol, set the `policies:iiop_tls:max_chain_length_policy` variable, which takes precedence.

`max_chain_length_policy` specifies the maximum certificate chain length that an ORB will accept. The policy can also be set programmatically using the `IT_TLS_API::MaxChainLengthPolicy` CORBA policy. Default is 2.

**Note:** The `max_chain_length_policy` is not currently supported on the z/OS platform.

---

## mechanism\_policy:accept\_v2\_hellos

A generic variable that sets this policy both for `iiop_tls` and `https`. To set this policy for a specific protocol, set

`policies:iiop_tls:mechanism_policy:accept_v2_hellos` or `policies:https:mechanism_policy:accept_v2_hellos` respectively for IIOp/TLS or HTTPS.

The `accept_v2_hellos` policy is a special setting that facilitates interoperability with an Artix application deployed on the z/OS platform. When `true`, the Artix application accepts V2 client hellos, but continues the

handshake using either the SSL\_V3 or TLS\_V1 protocol. When `false`, the Artix application throws an error, if it receives a V2 client hello. The default is `false`.

For example:

```
policies:mechanism_policy:accept_v2_hellos = "true";
```

---

## mechanism\_policy:ciphersuites

A generic variable that sets this policy both for `iiop_tls` and `https`. To set this policy for a specific protocol, set

`policies:iiop_tls:mechanism_policy:ciphersuites` OR `policies:https:mechanism_policy:ciphersuites` respectively for IIOP/TLS or HTTPS.

`mechanism_policy:ciphersuites` specifies a list of cipher suites for the default mechanism policy. One or more of the cipher suites shown in [Table 18](#) can be specified in this list.

**Table 18:** *Mechanism Policy Cipher Suites*

Null Encryption, Integrity and Authentication Ciphers	Standard Ciphers
RSA_WITH_NULL_MD5	RSA_EXPORT_WITH_RC4_40_MD5
RSA_WITH_NULL_SHA	RSA_WITH_RC4_128_MD5
	RSA_WITH_RC4_128_SHA
	RSA_EXPORT_WITH_DES40_CBC_SHA
	RSA_WITH_DES_CBC_SHA
	RSA_WITH_3DES_EDE_CBC_SHA

If you do not specify the list of cipher suites explicitly, all of the null encryption ciphers are disabled and all of the non-export strength ciphers are supported by default.

---

## mechanism\_policy:protocol\_version

A generic variable that sets this policy both for `iiop_tls` and `https`. To set this policy for a specific protocol, set

```
policies:iiop_tls:mechanism_policy:protocol_version OR  
policies:https:mechanism_policy:protocol_version respectively for  
IIOP/TLS or HTTPS.
```

`mechanism_policy:protocol_version` specifies the list of protocol versions used by a security capsule (ORB instance). The list can include one or more of the values `SSL_V3` and `TLS_V1`. For example:

```
policies:mechanism_policy:protocol_version=["TLS_V1", "SSL_V3"];
```

---

## session\_caching\_policy

A generic variable that sets this policy both for `iiop_tls` and `https`. To set this policy specifically for the IIOP/TLS protocol, set the

```
policies:iiop_tls:session_caching_policy
```

 variable, which takes precedence.

`session_caching_policy` specifies whether an ORB caches the session information for secure associations when acting in a client role, a server role, or both. The purpose of session caching is to enable closed connections to be re-established quickly. The following values are supported:

`CACHE_NONE`(default)

`CACHE_CLIENT`

`CACHE_SERVER`

`CACHE_SERVER_AND_CLIENT`

The policy can also be set programmatically using the

`IT_TLS_API::SessionCachingPolicy` CORBA policy.

---

## target\_secure\_invocation\_policy:requires

A generic variable that sets this policy both for `iiop_tls` and `https`. To set this policy specifically for the IOP/TLS protocol, set the `policies:iiop_tls:target_secure_invocation_policy:requires` variable, which takes precedence.

`target_secure_invocation_policy:requires` specifies the minimum level of security required by a server. The value of this variable is specified as a list of association options.

**Note:** In accordance with CORBA security, this policy cannot be downgraded programmatically by the application.

---

## target\_secure\_invocation\_policy:supports

A generic variable that sets this policy both for `iiop_tls` and `https`. To set this policy specifically for the IOP/TLS protocol, set the `policies:iiop_tls:target_secure_invocation_policy:supports` variable, which takes precedence.

`supports` specifies the maximum level of security supported by a server. The value of this variable is specified as a list of association options. This policy can be upgraded programmatically using either the `QOP` or the `EstablishTrust` policies.

---

## trusted\_ca\_list\_policy

A generic variable that sets this policy both for `iiop_tls` and `https`. To set this policy for a specific protocol, set

```
policies:iiop_tls:trusted_ca_list_policy OR  
policies:https:trusted_ca_list_policy
```

 respectively for IIOP/TLS or HTTPS.

`trusted_ca_list_policy` specifies a list of filenames, each of which contains a concatenated list of CA certificates in PEM format. The aggregate of the CAs in all of the listed files is the set of trusted CAs.

For example, you might specify two files containing CA lists as follows:

```
policies:trusted_ca_list_policy =  
  ["install_dir/asp/version/etc/tls/x509/ca/ca_list1.pem",  
   "install_dir/asp/version/etc/tls/x509/ca/ca_list_extra.pem"];
```

The purpose of having more than one file containing a CA list is for administrative convenience. It enables you to group CAs into different lists and to select a particular set of CAs for a security domain by choosing the appropriate CA lists.

---

# policies:asp

The `policies:asp` namespace contains the following variables:

- `enable_authorization`
- `enable_security`
- `enable_sso`
- `load_balancing_policy`
- `use_artix_proxies`

---

## enable\_authorization

A boolean variable that specifies whether Artix should enable authorization using the Artix Security Framework. Default is `true`.

**Note:** From Artix 4.0 onwards, the default value of `policies:asp:enable_authorization` is `true`. For versions of Artix prior to 4.0, the default value of `policies:asp:enable_authorization` is `false`.

---

## enable\_security

A boolean variable that specifies whether Artix should enable security using the Artix Security Framework. When this variable is set to `false`, all security features that depend on the `artix_security` plug-in (that is, authentication and authorization using the Artix security service) are disabled. Default is `true`.

**Note:** From Artix 4.0 onwards, the default value of `policies:asp:enable_security` is `true`. For versions of Artix prior to 4.0, the default value of `policies:asp:enable_security` is `false`.

---

## enable\_sso

This configuration variable is obsolete and has no effect.

---

## load\_balancing\_policy

When client load balancing is enabled, this variable specifies how often the Artix security plug-in reconnects to a node in the security service cluster. There are two possible values for this policy:

- `per-server`—(*the default*) after selecting a particular security service from the cluster, the client remains connected to that security service instance for the rest of the session.
- `per-request`—for each new request, the Artix security plug-in selects and connects to a new security service node (in accordance with the algorithm specified by `policies:iiop_tls:load_balancing_mechanism`).

**Note:** The process of re-establishing a secure connection with every new request imposes a significant performance overhead. Therefore, the `per-request` policy value is *not* recommended for most deployments.

This policy is used in conjunction with the `plugins:asp:enable_security_service_load_balancing` and `policies:iiop_tls:load_balancing_mechanism` configuration variables.

Default is `per-server`.

---

## use\_artix\_proxies

A boolean variable that specifies whether a client of the Artix security service connects to the security service through a WSDL contract or through a CORBA object reference. The `policies:asp:use_artix_proxies` variable can have the following values:

- `true`—connect to the security service through a WSDL contract. The location of the security service WSDL contract can be specified using the `bus:initial_contract:url:isf_service` configuration variable.
- `false`—connect to the security service through a CORBA object reference. The object reference is specified by the `initial_references:IT_SecurityService:reference` configuration variable.



Default is false.

---

## policies:bindings

The `policies:bindings` namespace contains the following variables:

- [corba:gssup\\_propagation](#)
- [corba:token\\_propagation](#)
- [soap:gssup\\_propagation](#)
- [soap:token\\_propagation](#)

---

### corba:gssup\_propagation

A boolean variable that can be used in a SOAP-to-CORBA router to enable the transfer of incoming SOAP credentials into outgoing CORBA credentials.

The CORBA binding extracts the username and password credentials from incoming SOAP/HTTP invocations and inserts them into an outgoing GSSUP credentials object, to be transmitted using CSI authentication over transport. The domain name in the outgoing GSSUP credentials is set to a blank string. Default is `false`.

---

### corba:token\_propagation

A boolean variable that can be used in a SOAP-to-CORBA router to enable the transfer of an SSO token from an incoming SOAP request into an outgoing CORBA request.

The CORBA binding extracts the SSO token from incoming SOAP/HTTP invocations and inserts the token into an outgoing IIOP request, to be transmitted using CSI identity assertion.

---

### soap:gssup\_propagation

A boolean variable that can be used in a CORBA-to-SOAP router to enable the transfer of incoming CORBA credentials into outgoing SOAP credentials.

The SOAP binding extracts the username and password from incoming IIOp invocations (where the credentials are embedded in a GIOP service context and encoded according to the CSI and GSSUP standards), and inserts them into an outgoing SOAP header, encoded using the WSS standard.

Default is `false`.

---

## **soap:token\_propagation**

A boolean variable that can be used in a CORBA-to-SOAP router to enable the transfer of an SSO token from an incoming CORBA request into an outgoing SOAP request.

The SOAP binding extracts the SSO token from an incoming IIOp request and inserts the token into the header of an outgoing SOAP/HTTP request.

---

## policies:csi

The `policies:csi` namespace includes variables that specify settings for Common Secure Interoperability version 2 (CSIv2):

- `attribute_service:backward_trust:enabled`
- `attribute_service:client_supports`
- `attribute_service:target_supports`
- `auth_over_transport:authentication_service`
- `auth_over_transport:client_supports`
- `auth_over_transport:server_domain_name`
- `auth_over_transport:target_requires`
- `auth_over_transport:target_supports`

---

### `attribute_service:backward_trust:enabled`

(Obsolete)

---

### `attribute_service:client_supports`

`attribute_service:client_supports` is a client-side policy that specifies the association options supported by the CSIv2 attribute service (principal propagation). The only association option that can be specified is `IdentityAssertion`. This policy is normally specified in an intermediate server so that it propagates CSIv2 identity tokens to a target server. For example:

```
policies:csi:attribute_service:client_supports =  
    ["IdentityAssertion"];
```

---

## attribute\_service:target\_supports

`attribute_service:target_supports` is a server-side policy that specifies the association options supported by the CSIV2 attribute service (principal propagation). The only association option that can be specified is `IdentityAssertion`. For example:

```
policies:csi:attribute_service:target_supports =  
  ["IdentityAssertion"];
```

---

## auth\_over\_transport:authentication\_service

(Java CSI plug-in only) The name of a Java class that implements the `IT_CSI::AuthenticateGSSUPCredentials` IDL interface. The authentication service is implemented as a callback object that plugs into the CSIV2 framework on the server side. By replacing this class with a custom implementation, you could potentially implement a new security technology domain for CSIV2.

By default, if no value for this variable is specified, the Java CSI plug-in uses a default authentication object that always returns `false` when the `authenticate()` operation is called.

---

## auth\_over\_transport:client\_supports

`auth_over_transport:client_supports` is a client-side policy that specifies the association options supported by CSIV2 authorization over transport. The only association option that can be specified is `EstablishTrustInClient`. For example:

```
policies:csi:auth_over_transport:client_supports =  
  ["EstablishTrustInClient"];
```

---

## auth\_over\_transport:server\_domain\_name

The iSF security domain (CSlv2 authentication domain) to which this server application belongs. The iSF security domains are administered within an overall security technology domain.

The value of the `server_domain_name` variable will be embedded in the IORs generated by the server. A CSlv2 client about to open a connection to this server would check that the domain name in its own CSlv2 credentials matches the domain name embedded in the IOR.

---

## auth\_over\_transport:target\_requires

`auth_over_transport:target_requires` is a server-side policy that specifies the association options required for CSlv2 authorization over transport. The only association option that can be specified is `EstablishTrustInClient`. For example:

```
policies:csi:auth_over_transport:target_requires =  
  ["EstablishTrustInClient"];
```

---

## auth\_over\_transport:target\_supports

`auth_over_transport:target_supports` is a server-side policy that specifies the association options supported by CSlv2 authorization over transport. The only association option that can be specified is `EstablishTrustInClient`. For example:

```
policies:csi:auth_over_transport:target_supports =  
  ["EstablishTrustInClient"];
```

---

# policies:external\_token\_issuer

The `policies:external_token_issuer` namespace contains the following variables:

- `client_certificate_constraints`

---

## client\_certificate\_constraints

To facilitate interoperability with Artix on the mainframe, the Artix security service can be configured to issue security tokens based on a username only (no password required). This feature is known as the *external token issuer*. Because this feature could potentially open a security hole in the Artix security service, the external token issuer is made available *only* to those applications that present a certificate matching the constraints specified in `policies:external_token_issuer:client_certificate_constraints`. For details of how to specify certificate constraints, see [“Applying Constraints to Certificates” on page 605](#).

For example, by inserting the following setting into the security service’s configuration scope in the Artix `.cfg` file, you would effectively disable the external token issuer (recommended for deployments that do not need to interoperate with the mainframe).

```
# DISABLE the security service’s external token issuer.  
# Note: The empty list matches no certificates.  
#  
policies:external_token_issuer:client_certificate_constraints =  
[];
```

This configuration variable must be set in the security server’s configuration scope, otherwise the security server will not start.

---

## policies:https

The `policies:https` namespace contains variables used to configure the https plugin. It contains the following variables:

- `mechanism_policy:accept_v2_hellos`
- `mechanism_policy:ciphersuites`
- `mechanism_policy:protocol_version`
- `trace_requests:enabled`
- `trusted_ca_list_policy`

---

### mechanism\_policy:accept\_v2\_hellos

This HTTPS-specific policy overrides the generic `policies:mechanism_policy:accept_v2_hellos` policy.

The `accept_v2_hellos` policy is a special setting that facilitates HTTPS interoperability with certain Web browsers. Many Web browsers send SSL V2 client hellos, because they do not know what SSL version the server supports.

When `true`, the Artix server accepts V2 client hellos, but continues the handshake using either the `SSL_V3` or `TLS_V1` protocol. When `false`, the Artix server throws an error, if it receives a V2 client hello. The default is `true`.

**Note:** This default value is deliberately different from the `policies:iioptls:mechanism_policy:accept_v2_hellos` default value.

For example:

```
policies:https:mechanism_policy:accept_v2_hellos = "true";
```



---

## mechanism\_policy:ciphersuites

Specifies a list of cipher suites for the default mechanism policy. One or more of the following cipher suites can be specified in this list:

**Table 19:** *Mechanism Policy Cipher Suites*

Null Encryption, Integrity and Authentication Ciphers	Standard Ciphers
RSA_WITH_NULL_MD5	RSA_EXPORT_WITH_RC4_40_MD5
RSA_WITH_NULL_SHA	RSA_WITH_RC4_128_MD5
	RSA_WITH_RC4_128_SHA
	RSA_EXPORT_WITH_DES40_CBC_SHA
	RSA_WITH_DES_CBC_SHA
	RSA_WITH_3DES_EDE_CBC_SHA

If you do not specify the list of cipher suites explicitly, all of the null encryption ciphers are disabled and all of the non-export strength ciphers are supported by default.

---

## mechanism\_policy:protocol\_version

This HTTPS-specific policy overrides the generic `policies:mechanism_policy:protocol_version` policy.

Specifies the list of protocol versions used by a security capsule (ORB instance). Can include one or more of the following values:

TLS\_V1  
SSL\_V3

The default setting is `SSL_V3` and `TLS_V1`.

For example:

```
policies:https:mechanism_policy:protocol_version = ["TLS_V1",
  "SSL_V3"];
```

---

## trace\_requests:enabled

Specifies whether to enable HTTPS-specific trace logging. The default is `false`. To enable HTTPS tracing, set this variable as follows:

```
policies:https:trace_requests:enabled="true";
```

This setting outputs `INFO` level messages that show full HTTP buffers (headers and body) as they go to and from the wire.

You must also set log filtering as follows to pick up the additional HTTPS messages, and then resend the logs:

```
event_log:filters = ["*-*"];
```

For example, you could enable HTTPS trace logging to verify that authentication headers are written to the wire correctly.

Similarly, to enable HTTP-specific trace logging, use the following setting:

```
policies:http:trace_requests:enabled="true";
```

---

## trusted\_ca\_list\_policy

Contains a list of filenames (or a single filename), each of which contains a concatenated list of CA certificates in PEM format. The aggregate of the CAs in all of the listed files is the set of trusted CAs.

For example, you might specify two files containing CA lists as follows:

```
policies:trusted_ca_list_policy =  
  ["ASPInstallDir/asp/6.0/etc/tls/x509/ca/ca_list1.pem",  
   "ASPInstallDir/asp/6.0/etc/tls/x509/ca/ca_list_extra.pem"];
```

The purpose of having more than one file containing a CA list is for administrative convenience. It enables you to group CAs into different lists and to select a particular set of CAs for a security domain by choosing the appropriate CA lists.

---

## policies:iiop\_tls

The `policies:iiop_tls` namespace contains variables used to set IIOF-related policies for a secure environment. These settings affect the `iiop_tls` plugin. It contains the following variables:

- `allow_unauthenticated_clients_policy`
- `buffer_sizes_policy:default_buffer_size`
- `buffer_sizes_policy:max_buffer_size`
- `certificate_constraints_policy`
- `client_secure_invocation_policy:requires`
- `client_secure_invocation_policy:supports`
- `client_version_policy`
- `connection_attempts`
- `connection_retry_delay`
- `load_balancing_mechanism`
- `max_chain_length_policy`
- `mechanism_policy:accept_v2_hellos`
- `mechanism_policy:ciphersuites`
- `mechanism_policy:protocol_version`
- `server_address_mode_policy:local_domain`
- `server_address_mode_policy:local_hostname`
- `server_address_mode_policy:port_range`
- `server_address_mode_policy:publish_hostname`
- `server_version_policy`
- `session_caching_policy`
- `target_secure_invocation_policy:requires`
- `target_secure_invocation_policy:supports`
- `tcp_options_policy:no_delay`
- `tcp_options_policy:recv_buffer_size`
- `tcp_options_policy:send_buffer_size`
- `trusted_ca_list_policy`

---

## allow\_unauthenticated\_clients\_policy

A boolean variable that specifies whether a server will allow a client to establish a secure connection without sending a certificate. Default is `false`. This configuration variable is applicable *only* in the special case where the target secure invocation policy is set to require `NoProtection` (a semi-secure server).

---

## buffer\_sizes\_policy:default\_buffer\_size

When this policy is set, the `iiop_tls` plug-in reads this policy's value instead of the `policies:iiop:buffer_sizes_policy:default_buffer_size` policy's value.

`buffer_sizes_policy:default_buffer_size` specifies, in bytes, the initial size of the buffers allocated by IIOP. Defaults to 16000. This value must be greater than 80 bytes, and must be evenly divisible by 8.

---

## buffer\_sizes\_policy:max\_buffer\_size

When this policy is set, the `iiop_tls` plug-in reads this policy's value instead of the `policies:iiop:buffer_sizes_policy:max_buffer_size` policy's value.

`buffer_sizes_policy:max_buffer_size` specifies the maximum buffer size permitted by IIOP, in kilobytes. Defaults to 512. A value of -1 indicates unlimited size. If not unlimited, this value must be greater than 80.

---

## certificate\_constraints\_policy

A list of constraints applied to peer certificates—see the discussion of certificate constraints in the Artix security guide for the syntax of the pattern constraint language. If a peer certificate fails to match any of the constraints, the certificate validation step will fail.

The policy can also be set programmatically using the `IT_TLS_API::CertConstraintsPolicy` CORBA policy. Default is no constraints.

---

## client\_secure\_invocation\_policy:requires

Specifies the minimum level of security required by a client. The value of this variable is specified as a list of association options—see the *Artix Security Guide* for more details about association options.

In accordance with CORBA security, this policy cannot be downgraded programmatically by the application.

---

## client\_secure\_invocation\_policy:supports

Specifies the initial maximum level of security supported by a client. The value of this variable is specified as a list of association options—see the *Artix Security Guide* for more details about association options.

This policy can be upgraded programmatically using either the `QOP` or the `EstablishTrust` policies.

---

## client\_version\_policy

`client_version_policy` specifies the highest IIOp version used by clients. A client uses the version of IIOp specified by this variable, or the version specified in the IOR profile, whichever is lower. Valid values for this variable are: 1.0, 1.1, and 1.2.

For example, the following file-based configuration entry sets the server IIOp version to 1.1.

```
policies:iiop:server_version_policy="1.1";
```

The following `itadmin` command set this variable:

```
itadmin variable modify -type string -value "1.1"  
policies:iiop:server_version_policy
```

---

## connection\_attempts

`connection_attempts` specifies the number of connection attempts used when creating a connected socket using a Java application. Defaults to 5.

---

## connection\_retry\_delay

`connection_retry_delay` specifies the delay, in seconds, between connection attempts when using a Java application. Defaults to 2.

---

## load\_balancing\_mechanism

Specifies the load balancing mechanism for the client of a security service cluster (see also `plugins:gsp:use_client_load_balancing` and `plugins:asp:enable_security_service_load_balancing`). In this context, a client can also be an *Artix* server. This policy only affects connections made using IORs that contain multiple addresses. The `iiop_tls` plug-in load balances over the addresses embedded in the IOR.

The following mechanisms are supported:

- `random`—choose one of the addresses embedded in the IOR at random (this is the default).
- `sequential`—choose the first address embedded in the IOR, moving on to the next address in the list only if the previous address could not be reached.

---

## max\_chain\_length\_policy

This policy overrides `policies:max_chain_length_policy` for the `iiop_tls` plugin.

The maximum certificate chain length that an ORB will accept.

The policy can also be set programmatically using the `IT_TLS_API::MaxChainLengthPolicy` CORBA policy. Default is 2.

**Note:** The `max_chain_length_policy` is not currently supported on the z/OS platform.

---

## mechanism\_policy:accept\_v2\_hellos

This IIOP/TLS-specific policy overrides the generic `policies:mechanism_policy:accept_v2_hellos` policy.

The `accept_v2_hellos` policy is a special setting that facilitates interoperability with an Artix application deployed on the z/OS platform. Artix security on the z/OS platform is based on IBM's System/SSL toolkit, which implements SSL version 3, but does so by using SSL version 2 hellos as part of the handshake. This form of handshake causes interoperability problems, because applications on other platforms identify the handshake as an SSL version 2 handshake. The misidentification of the SSL protocol version can be avoided by setting the `accept_v2_hellos` policy to `true` in the non-z/OS application (this bug also affects some old versions of Microsoft Internet Explorer).

When `true`, the Artix application accepts V2 client hellos, but continues the handshake using either the `SSL_V3` or `TLS_V1` protocol. When `false`, the Artix application throws an error, if it receives a V2 client hello. The default is `false`.

**Note:** This default value is deliberately different from the `policies:https:mechanism_policy:accept_v2_hellos` default value.

For example:

```
policies:iiop_tls:mechanism_policy:accept_v2_hellos = "true";
```

---

## mechanism\_policy:ciphersuites

This policy overrides `policies:mechanism_policy:ciphersuites` for the `iiop_tls` plugin.

Specifies a list of cipher suites for the default mechanism policy. One or more of the following cipher suites can be specified in this list:

**Table 20:** *Mechanism Policy Cipher Suites*

Null Encryption, Integrity and Authentication Ciphers	Standard Ciphers
<code>RSA_WITH_NULL_MD5</code>	<code>RSA_EXPORT_WITH_RC4_40_MD5</code>
<code>RSA_WITH_NULL_SHA</code>	<code>RSA_WITH_RC4_128_MD5</code>
	<code>RSA_WITH_RC4_128_SHA</code>
	<code>RSA_EXPORT_WITH_DES40_CBC_SHA</code>

**Table 20:** *Mechanism Policy Cipher Suites*

Null Encryption, Integrity and Authentication Ciphers	Standard Ciphers
	RSA_WITH_DES_CBC_SHA
	RSA_WITH_3DES_EDE_CBC_SHA

If you do not specify the list of cipher suites explicitly, all of the null encryption ciphers are disabled and all of the non-export strength ciphers are supported by default.

---

## mechanism\_policy:protocol\_version

This IIOP/TLS-specific policy overrides the generic `policies:mechanism_policy:protocol_version` policy.

Specifies the list of protocol versions used by a security capsule (ORB instance). Can include one or more of the following values:

TLS\_V1  
 SSL\_V3  
 SSL\_V2V3 (*Deprecated*)

The default setting is `SSL_V3` and `TLS_V1`.

For example:

```
policies:iiop_tls:mechanism_policy:protocol_version = ["TLS_V1",
  "SSL_V3"];
```

The `SSL_V2V3` value is now *deprecated*. It was previously used to facilitate interoperability with Artix applications deployed on the z/OS platform. If you have any legacy configuration that uses `SSL_V2V3`, you should replace it with the following combination of settings:

```
policies:iiop_tls:mechanism_policy:protocol_version = ["SSL_V3",
  "TLS_V1"];
policies:iiop_tls:mechanism_policy:accept_v2_hellos = "true";
```

---

## server\_address\_mode\_policy:local\_domain

(Java only) When this policy is set, the `iiop_tls` plug-in reads this policy's value instead of the

`policies:iiop:server_address_mode_policy:local_domain` policy's value.



---

## server\_address\_mode\_policy:local\_hostname

(Java only) When this policy is set, the `iiop_tls` plug-in reads this policy's value instead of the

`policies:iiop:server_address_mode_policy:local_hostname` policy's value.

`server_address_mode_policy:local_hostname` specifies the hostname advertised by the locator daemon, and listened on by server-side IIOP.

Some machines have multiple hostnames or IP addresses (for example, those using multiple DNS aliases or multiple network cards). These machines are often termed *multi-homed hosts*. The `local_hostname` variable supports these type of machines by enabling you to explicitly specify the host that servers listen on and publish in their IORs.

For example, if you have a machine with two network addresses (207.45.52.34 and 207.45.52.35), you can explicitly set this variable to either address:

```
policies:iiop:server_address_mode_policy:local_hostname =  
    "207.45.52.34";
```

By default, the `local_hostname` variable is unspecified. Servers use the default hostname configured for the machine with the Orbix configuration tool.

---

## server\_address\_mode\_policy:port\_range

(Java only) When this policy is set, the `iiop_tls` plug-in reads this policy's value instead of the

`policies:iiop:server_address_mode_policy:port_range` policy's value.

`server_address_mode_policy:port_range` specifies the range of ports that a server uses when there is no well-known addressing policy specified for the port.

---

## server\_address\_mode\_policy:publish\_hostname

When this policy is set, the `iiop_tls` plug-in reads this policy's value instead of the

`policies:iiop:server_address_mode_policy:publish_hostname` policy's value.

`server_address_mode_policy:publish_hostname` specifies whether IIOP exports hostnames or IP addresses in published profiles. Defaults to `false` (exports IP addresses, and does not export hostnames). To use hostnames in object references, set this variable to `true`, as in the following file-based configuration entry:

```
policies:iiop:server_address_mode_policy:publish_hostname=true
```

The following `itadmin` command is equivalent:

```
itadmin variable create -type bool -value true  
  policies:iiop:server_address_mode_policy:publish_hostname
```

---

## server\_version\_policy

When this policy is set, the `iiop_tls` plug-in reads this policy's value instead of the `policies:iiop:server_version_policy` policy's value.

`server_version_policy` specifies the GIOP version published in IIOP profiles. This variable takes a value of either `1.1` or `1.2`. Artix servers do not publish IIOP 1.0 profiles. The default value is `1.2`.

---

## session\_caching\_policy

This policy overrides `policies:session_caching_policy` for the `iiop_tls` plugin.

---

## target\_secure\_invocation\_policy:requires

This policy overrides

`policies:target_secure_invocation_policy:requires` for the `iiop_tls` plugin.

Specifies the minimum level of security required by a server. The value of this variable is specified as a list of association options—see the *Artix Security Guide* for more details about association options.

In accordance with CORBA security, this policy cannot be downgraded programmatically by the application.

---

## target\_secure\_invocation\_policy:supports

This policy overrides

`policies:target_secure_invocation_policy:supports` for the `iiop_tls` plugin.

Specifies the maximum level of security supported by a server. The value of this variable is specified as a list of association options—see the *Artix Security Guide* for more details about association options.

This policy can be upgraded programmatically using either the `QOP` or the `EstablishTrust` policies.

---

## tcp\_options\_policy:no\_delay

When this policy is set, the `iiop_tls` plug-in reads this policy's value instead of the `policies:iiop:tcp_options_policy:no_delay` policy's value.

`tcp_options_policy:no_delay` specifies whether the `TCP_NODELAY` option should be set on connections. Defaults to `false`.

---

## tcp\_options\_policy:recv\_buffer\_size

When this policy is set, the `iiop_tls` plug-in reads this policy's value instead of the `policies:iiop:tcp_options_policy:recv_buffer_size` policy's value.

`tcp_options_policy:recv_buffer_size` specifies the size of the TCP receive buffer. This variable can only be set to `0`, which corresponds to using the default size defined by the operating system.

---

## tcp\_options\_policy:send\_buffer\_size

When this policy is set, the `iiop_tls` plug-in reads this policy's value instead of the `policies:iiop:tcp_options_policy:send_buffer_size` policy's value.

`tcp_options_policy:send_buffer_size` specifies the size of the TCP send buffer. This variable can only be set to `0`, which corresponds to using the default size defined by the operating system.

---

## trusted\_ca\_list\_policy

This policy overrides the `policies:trusted_ca_list_policy` for the `iiop_tls` plugin.

Contains a list of filenames (or a single filename), each of which contains a concatenated list of CA certificates in PEM format. The aggregate of the CAs in all of the listed files is the set of trusted CAs.

For example, you might specify two files containing CA lists as follows:

```
policies:trusted_ca_list_policy =  
    ["ASPInstallDir/asp/6.0/etc/tls/x509/ca/ca_list1.pem",  
     "ASPInstallDir/asp/6.0/etc/tls/x509/ca/ca_list_extra.pem"];
```

The purpose of having more than one file containing a CA list is for administrative convenience. It enables you to group CAs into different lists and to select a particular set of CAs for a security domain by choosing the appropriate CA lists.

---

## policies:security\_server

The `policies:security_server` namespace contains the following variables:

- [client\\_certificate\\_constraints](#)

---

### client\_certificate\_constraints

Restricts access to the Artix security server, allowing only clients that match the specified certificate constraints to open a connection to the security service. For details of how to specify certificate constraints, see [“Applying Constraints to Certificates” on page 605](#).

For example, by inserting the following setting into the security service’s configuration scope in the Artix `.cfg` file, you can allow access by clients presenting the `administrator.p12` and `iona_utilities.p12` certificates (demonstration certificates).

```
# Allow access by demonstration client certificates.
# WARNING: These settings are NOT secure and must be customized
#           before deploying in a real system.
#
policies:security_server:client_certificate_constraints =
  ["C=US,ST=Massachusetts,O=ABigBank*,CN=Orbix2000 IONA
  Services (demo cert), OU=Demonstration Section -- no warranty
  --", "C=US,ST=Massachusetts,O=ABigBank*,CN=Abigbank Accounts
  Server*", "C=US,ST=Massachusetts,O=ABigBank*,CN=Iona
  utilities - demo purposes"];
```

The effect of setting this configuration variable is slightly different to the effect of setting `policies:iioptls:certificate_constraints_policy`. Whereas `policies:iioptls:certificate_constraints_policy` affects *all* services deployed in the current process, the `policies:security_server:client_certificate_constraints` variable affects only the Artix security service. This distinction is significant when the login server is deployed into the same process as the security server. In this case, you would typically want to configure the login server such that it does *not* require clients to present an X.509 certificate (this is the default), while the security server *does* require clients to present an X.509 certificate.

This configuration variable must be set in the security server's configuration scope, otherwise the security server will not start.

---

# policies:soap:security

The `policies:soap:security` namespace contains just a single configuration variable, as follows:

- `enforce_must_understand`

---

## enforce\_must\_understand

Specifies whether the Artix runtime enforces the semantics required by the `mustUnderstand` attribute, which appears in the WS-Security SOAP header.

The semantics are as follows: when the `mustUnderstand` attribute is set to 1, the message receiver *must* process all of the security elements contained in the corresponding `wsse:Security` header element. If the receiving program is unable to process the `wsse:Security` element completely, the message should be rejected.

You can disable this behavior by setting the `policies:soap:security:enforce_must_understand` variable to `false`.

Default is `true`.

The `mustUnderstand` attribute appears as follows in a SOAP 1.1 header:

```
<S11:Envelope>
  <S11:Header>
    ...
    <wsse:Security S11:actor="..." S11:mustUnderstand="...">
      ...
    </wsse:Security>
    ...
  </S11:Header>
  ...
</S11:Envelope>
```

---

# principal\_sponsor

The `principal_sponsor` namespace stores configuration information to be used when obtaining credentials. The CORBA binding provides an implementation of a principal sponsor that creates credentials for applications automatically.

Use of the `PrincipalSponsor` is disabled by default and can only be enabled through configuration.

The `PrincipalSponsor` represents an entry point into the secure system. It must be activated and authenticate the user, before any application-specific logic executes. This allows unmodified, security-unaware applications to have `Credentials` established transparently, prior to making invocations.

---

## In this section

The following variables are in this namespace:

- `use_principal_sponsor`
- `auth_method_id`
- `auth_method_data`
- `callback_handler:ClassName`
- `login_attempts`

---

## use\_principal\_sponsor

`use_principal_sponsor` specifies whether an attempt is made to obtain credentials automatically. Defaults to `false`. If set to `true`, the following `principal_sponsor` variables must contain data in order for anything to actually happen.



## auth\_method\_id

`auth_method_id` specifies the authentication method to be used. The following authentication methods are available:

<code>pkcs12_file</code>	The authentication method uses a PKCS#12 file.
<code>pkcs11</code>	Java only. The authentication data is provided by a smart card.
<code>security_label</code>	Windows and Schannel only. The authentication data is specified by supplying the common name (CN) from an application certificate's subject DN.

For example, you can select the `pkcs12_file` authentication method as follows:

```
principal_sponsor:auth_method_id = "pkcs12_file";
```

## auth\_method\_data

`auth_method_data` is a string array containing information to be interpreted by the authentication method represented by the `auth_method_id`.

For the `pkcs12_file` authentication method, the following authentication data can be provided in `auth_method_data`:

<code>filename</code>	A PKCS#12 file that contains a certificate chain and private key— <i>required</i> .
<code>password</code>	A password for the private key— <i>optional</i> .  It is bad practice to supply the password from configuration for deployed systems. If the password is not supplied, the user is prompted for it.
<code>password_file</code>	The name of a file containing the password for the private key— <i>optional</i> .  Make sure that the password file is read/write protected on your file system.

For the `pkcs11` (smart card) authentication method, the following authentication data can be provided in `auth_method_data`:

<code>provider</code>	A name that identifies the underlying PKCS #11 toolkit used by Artix to communicate with the smart card.  The toolkit currently used by Artix has the provider name <code>dkck132.dll</code> (from Baltimore).
<code>slot</code>	The number of a particular slot on the smart card (for example, 0) containing the user's credentials.
<code>pin</code>	A PIN to gain access to the smart card— <i>optional</i> .  It is bad practice to supply the PIN from configuration for deployed systems. If the PIN is not supplied, the user is prompted for it.

For the `security_label` authentication method on Windows, the following authentication data can be provided in `auth_method_data`:

<code>label</code>	(Windows and Schannel only.) The common name (CN) from an application certificate's subject DN
--------------------	------------------------------------------------------------------------------------------------

For example, to configure an application on Windows to use a certificate, `bob.p12`, whose private key is encrypted with the `bobpass` password, set the `auth_method_data` as follows:

```
principal_sponsor:auth_method_data =
  ["filename=c:\users\bob\bob.p12", "password=bobpass"];
```

The following points apply to Java implementations:

- If the file specified by `filename=` is not found, it is searched for on the classpath.
- The file specified by `filename=` can be supplied with a URL instead of an absolute file location.
- The mechanism for prompting for the password if the password is supplied through `password=` can be replaced with a custom mechanism, as demonstrated by the `login` demo.

- There are two extra configuration variables available as part of the `principal_sponsor` namespace, namely `principal_sponsor:callback_handler` and `principal_sponsor:login_attempts`. These are described below.
  - These Java-specific features are available subject to change in future releases; any changes that can arise probably come from customer feedback on this area.
- 

## **callback\_handler:ClassName**

`callback_handler:ClassName` specifies the class name of an interface that implements the interface `com.ionacorba.tls.auth.CallbackHandler`. This variable is only used for Java clients.

---

## **login\_attempts**

`login_attempts` specifies how many times a user is prompted for authentication data (usually a password). It applies for both internal and custom `CallbackHandlers`; if a `CallbackHandler` is supplied, it is invoked upon up to `login_attempts` times as long as the `PrincipalAuthenticator` returns `SecAuthFailure`. This variable is only used by Java clients.

---

## principal\_sponsor:csi

The `principal_sponsor:csi` namespace stores configuration information to be used when obtaining CSI (Common Secure Interoperability) credentials. It includes the following:

- `use_existing_credentials`
- `use_principal_sponsor`
- `auth_method_data`
- `auth_method_id`

---

### use\_existing\_credentials

A boolean value that specifies whether ORBs that share credentials can also share CSI credentials. If `true`, any CSI credentials loaded by one credential-sharing ORB can be used by other credential-sharing ORBs loaded after it; if `false`, CSI credentials are not shared.

This variable has no effect, unless the `plugins:security:share_credentials_across_orbs` variable is also `true`. Default is `false`.

---

### use\_principal\_sponsor

`use_principal_sponsor` is a boolean value that switches the CSI principal sponsor on or off.

If set to `true`, the CSI principal sponsor is enabled; if `false`, the CSI principal sponsor is disabled and the remaining `principal_sponsor:csi` variables are ignored. Defaults to `false`.

---

## auth\_method\_data

`auth_method_data` is a string array containing information to be interpreted by the authentication method represented by the `auth_method_id`.

For the GSSUPMech authentication method, the following authentication data can be provided in `auth_method_data`:

<code>username</code>	The username for CSIV2 authorization. This is optional. Authentication of CSIV2 usernames and passwords is performed on the server side. The administration of usernames depends on the particular security mechanism that is plugged into the server side see <a href="#">auth_over_transport:authentication_service</a> .
<code>password</code>	The password associated with username. This is optional. It is bad practice to supply the password from configuration for deployed systems. If the password is not supplied, the user is prompted for it.
<code>domain</code>	The CSIV2 authentication domain in which the username/password pair is authenticated.  When the client is about to open a new connection, this domain name is compared with the domain name embedded in the relevant IOR (see <a href="#">policies:csi:auth_over_transport:server_domain_name</a> ). The domain names must match.  <b>Note:</b> If <code>domain</code> is an empty string, it matches any target domain. That is, an empty domain string is equivalent to a wildcard.

If any of the preceding data are omitted, the user is prompted to enter authentication data when the application starts up.

For example, to log on to a CSIV2 application as the `administrator` user in the `US-SantaClara` domain:

```
principal_sponsor:csi:auth_method_data =  
  ["username=administrator", "domain=US-SantaClara"];
```

When the application is started, the user is prompted for the administrator password.

**Note:** It is currently not possible to customize the login prompt associated with the CSIv2 principal sponsor. As an alternative, you could implement your own login GUI by programming and pass the user input directly to the principal authenticator.

---

## auth\_method\_id

`auth_method_id` specifies a string that selects the authentication method to be used by the CSI application. The following authentication method is available:

<code>GSSUPMech</code>	The Generic Security Service Username/Password (GSSUP) mechanism.
------------------------	-------------------------------------------------------------------

For example, you can select the GSSUPMech authentication method as follows:

```
principal_sponsor:csi:auth_method_id = "GSSUPMech";
```

---

# principal\_sponsor:http

The `principal_sponsor:http` namespace provides configuration variables that enable you to specify the HTTP Basic Authentication username and password credentials.

**Note:** Once the HTTP principal sponsor is enabled, the HTTP header containing the username and password is *always* included in outgoing messages. For example, it is not possible to omit the HTTP Basic Authentication credentials while talking to security unaware services. It is possible, however, to program the application to set the username and password values equal to empty strings.

The principal sponsor is disabled by default.

For example, to configure a HTTP client to use the credentials `test_username` and `test_password`, configure the HTTP principal sponsor as follows:

```
principal_sponsor:http:use_principal_sponsor = "true";
principal_sponsor:http:auth_method_id = "USERNAME_PASSWORD";
principal_sponsor:http:auth_method_data =
    ["username=test_username", "password=test_password"];
```

---

## In this section

The following variables are in this namespace:

- `use_principal_sponsor`
- `auth_method_id`
- `auth_method_data`

---

## use\_principal\_sponsor

`use_principal_sponsor` is used to enable or disable the HTTP principal sponsor. Defaults to `false`. If set to `true`, the following `principal_sponsor:http` variables must be set:

- `auth_method_id`
- `auth_method_data`

---

## auth\_method\_id

`auth_method_id` specifies the authentication method to be used. The following authentication methods are available:

`USERNAME_PASSWORD` The authentication method reads the HTTP Basic Authentication username and password from the `auth_method_data` variable.

For example, you can select the `USERNAME_PASSWORD` authentication method as follows:

```
principal_sponsor:http:auth_method_id = "USERNAME_PASSWORD";
```

---

## auth\_method\_data

`auth_method_data` is a string array containing information to be interpreted by the authentication method represented by the `auth_method_id`.

For the `USERNAME_PASSWORD` authentication method, the following authentication data can be provided in `auth_method_data`:

<code>username</code>	The HTTP Basic Authentication username— <i>required</i> .
<code>password</code>	The HTTP Basic Authentication password. It is bad practice to supply the password from configuration for deployed systems. If the password is not supplied, the user is prompted for it.
<code>password_file</code>	The name of a file containing the HTTP Basic Authentication password.

The `username` field is required, and you can include either a `password` field or a `password_file` field to specify the password.

For example, to configure an application with the username, `test_username`, whose password is stored in the `wsse_password_file.txt` file, set the `auth_method_data` as follows:

```
principal_sponsor:http:auth_method_data =
  ["username=test_username",
   "password_file=wsse_password_file.txt"];
```



---

# principal\_sponsor:https

The `principal_sponsor:https` namespace provides configuration variables that enable you to specify the *own credentials* used with the HTTPS transport.

The HTTPS principal sponsor is disabled by default.

---

## In this section

The following variables are in this namespace:

- `use_principal_sponsor`
- `auth_method_id`
- `auth_method_data`

---

## use\_principal\_sponsor

`use_principal_sponsor` specifies whether an attempt is made to obtain credentials automatically. Defaults to `false`. If set to `true`, the following `principal_sponsor:https` variables must contain data in order for anything to actually happen:

- `auth_method_id`
- `auth_method_data`

---

## auth\_method\_id

`auth_method_id` specifies the authentication method to be used. The following authentication methods are available:

`pkcs12_file` The authentication method uses a PKCS#12 file

For example, you can select the `pkcs12_file` authentication method as follows:

```
principal_sponsor:https:auth_method_id = "pkcs12_file";
```

---

## auth\_method\_data

`auth_method_data` is a string array containing information to be interpreted by the authentication method represented by the `auth_method_id`.

For the `pkcs12_file` authentication method, the following authentication data can be provided in `auth_method_data`:

`filename` A PKCS#12 file that contains a certificate chain and private key—*required*.

`password` A password for the private key.

It is bad practice to supply the password from configuration for deployed systems. If the password is not supplied, the user is prompted for it.

`password_file` The name of a file containing the password for the private key.

This option is not recommended for deployed systems.

For example, to configure an application on Windows to use a certificate, `bob.p12`, whose private key is encrypted with the `bobpass` password, set the `auth_method_data` as follows:

```
principal_sponsor:https:auth_method_data =  
  ["filename=c:\users\bob\bob.p12", "password=bobpass"];
```

---

# principal\_sponsor:iiop\_tls

The `principal_sponsor:iiop_tls` namespace provides configuration variables that enable you to specify the *own credentials* used with the IIOp/TLS transport.

The IIOp/TLS principal sponsor is disabled by default.

---

## In this section

The following variables are in this namespace:

- `use_principal_sponsor`
- `auth_method_id`
- `auth_method_data`

---

## use\_principal\_sponsor

`use_principal_sponsor` specifies whether an attempt is made to obtain credentials automatically. Defaults to `false`. If set to `true`, the following `principal_sponsor:iiop_tls` variables must contain data in order for anything to actually happen:

- `auth_method_id`
- `auth_method_data`

---

## auth\_method\_id

`auth_method_id` specifies the authentication method to be used. The following authentication methods are available:

`pkcs12_file`      The authentication method uses a PKCS#12 file

For example, you can select the `pkcs12_file` authentication method as follows:

```
principal_sponsor:iioptls:auth_method_id = "pkcs12_file";
```

---

## auth\_method\_data

`auth_method_data` is a string array containing information to be interpreted by the authentication method represented by the `auth_method_id`.

For the `pkcs12_file` authentication method, the following authentication data can be provided in `auth_method_data`:

<code>filename</code>	A PKCS#12 file that contains a certificate chain and private key— <i>required</i> .
<code>password</code>	A password for the private key. It is bad practice to supply the password from configuration for deployed systems. If the password is not supplied, the user is prompted for it.
<code>password_file</code>	The name of a file containing the password for the private key. The password file must be read and write protected to prevent tampering.

For example, to configure an application on Windows to use a certificate, `bob.p12`, whose private key is encrypted with the `bobpass` password, set the `auth_method_data` as follows:

```
principal_sponsor:iioptls:auth_method_data =
  ["filename=c:\users\bob\bob.p12", "password=bobpass"];
```

---

## principal\_sponsor:wsse

The `principal_sponsor:wsse` namespace provides configuration variables that enable you to specify the WSS username and password credentials sent in a SOAP header.

**Note:** Once the WSS principal sponsor is enabled, the SOAP header containing the WSS username and password is *always* included in outgoing messages. For example, it is not possible to omit the WSS username/password header while talking to security unaware services. It is possible, however, to program the application to set the username and password values equal to empty strings.

The principal sponsor is disabled by default.

For example, to configure a SOAP client to use the credentials `test_username` and `test_password`, configure the WSS principal sponsor as follows:

```
principal_sponsor:wsse:use_principal_sponsor = "true";
principal_sponsor:wsse:auth_method_id = "USERNAME_PASSWORD";
principal_sponsor:wsse:auth_method_data =
    ["username=test_username", "password=test_password"];
```

If you use a SOAP 1.2 binding, you must also include the following configuration in the client and in the server:

```
# Artix .cfg file
...
orb_plugins = ["xmlfile_log_stream", "artix_security", ...];

plugins:artix_security:shlib_name = "it_security_plugin";
binding:artix:server_request_interceptor_list =
    "principal_context+security";
binding:artix:client_request_interceptor_list =
    "security+principal_context";
```

---

**In this section**

The following variables are in this namespace:

- `use_principal_sponsor`
  - `auth_method_id`
  - `auth_method_data`
- 

**use\_principal\_sponsor**

`use_principal_sponsor` is used to enable or disable the WSS principal sponsor. Defaults to `false`. If set to `true`, the following `principal_sponsor:wsse` variables must be set:

- `auth_method_id`
  - `auth_method_data`
- 

**auth\_method\_id**

`auth_method_id` specifies the authentication method to be used. The following authentication methods are available:

`USERNAME_PASSWORD` The authentication method reads the WSS username and password from the `auth_method_data` variable.

For example, you can select the `USERNAME_PASSWORD` authentication method as follows:

```
principal_sponsor:wsse:auth_method_id = "USERNAME_PASSWORD";
```

---

**auth\_method\_data**

`auth_method_data` is a string array containing information to be interpreted by the authentication method represented by the `auth_method_id`.

For the `USERNAME_PASSWORD` authentication method, the following authentication data can be provided in `auth_method_data`:

`username` The WSS username—*required*.

`password` The WSS password.  
It is bad practice to supply the password from configuration for deployed systems. If the password is not supplied, the user is prompted for it.

`password_file` The name of a file containing the WSS password.

The `username` field is required, and you can include either a `password` field or a `password_file` field to specify the password.

For example, to configure an application with the WSS username, `test_username`, whose password is stored in the `wsse_password_file.txt` file, set the `auth_method_data` as follows:

```
principal_sponsor:wsse:auth_method_data =  
  ["username=test_username",  
   "password_file=wsse_password_file.txt"];
```





# iSF Configuration

*This appendix provides details of how to configure the Artix security server.*

**In this appendix**

---

This appendix contains the following sections:

<a href="#">Properties File Syntax</a>	<a href="#">page 698</a>
<a href="#">iSF Properties File</a>	<a href="#">page 699</a>
<a href="#">Cluster Properties File</a>	<a href="#">page 725</a>
<a href="#">log4j Properties File</a>	<a href="#">page 728</a>

---

# Properties File Syntax

---

## Overview

The Artix security service uses standard Java property files for its configuration. Some aspects of the Java properties file syntax are summarized here for your convenience.

## Property definitions

A property is defined with the following syntax:

```
<PropertyName>=<PropertyValue>
```

The `<PropertyName>` is a compound identifier, with each component delimited by the `.` (period) character. For example, `is2.current.server.id`. The `<PropertyValue>` is an arbitrary string, including all of the characters up to the end of the line (embedded spaces are allowed).

## Specifying full pathnames

When setting a property equal to a filename, you normally specify a full pathname, as follows:

### UNIX

```
/home/data/securityInfo.xml
```

### Windows

```
D:/iona/securityInfo.xml
```

or, if using the backslash as a delimiter, it must be escaped as follows:

```
D:\\iona\\securityInfo.xml
```

## Specifying relative pathnames

If you specify a relative pathname when setting a property, the root directory for this path must be added to the Artix security service's classpath. For example, if you specify a relative pathname as follows:

### UNIX

```
securityInfo.xml
```

The security service's classpath must include the file's parent directory:

```
CLASSPATH = /home/data/:<rest_of_classpath>
```

---

# iSF Properties File

---

## Overview

An iSF properties file is used to store the properties that configure a specific Artix security service instance. Generally, every Artix security service instance should have its own iSF properties file. This section provides descriptions of all the properties that can be specified in an iSF properties file.

## File location

The default locations of the iSF property files are as follows:

```
ArtixInstallDir/cxx_java/samples/security/full_security/etc/is2.  
properties.FILE  
ArtixInstallDir/cxx_java/etc/is2.properties.LDAP  
ArtixInstallDir/cxx_java/etc/is2.properties.KERBEROS
```

In general, the iSF properties file location is specified in the Artix configuration by setting the `is2.properties` property in the `plugins:java_server:system_properties` property list.

For example, on UNIX the security server's property list is normally initialized in the `iona_services.security` configuration scope as follows:

```
# Artix configuration file  
...  
iona_services {  
    ...  
    security {  
        ...  
        plugins:java_server:system_properties =  
        ["org.omg.CORBA.ORBClass=com.ion.corba.art.artimpl.ORBImpl",  
        "org.omg.CORBA.ORBSingletonClass=com.ion.corba.art.artimpl.O  
RBSingleton",  
        "is2.properties=ArtixInstallDir/cxx_java/samples/security/ful  
l_security/etc/is2.properties.FILE"];  
        ...  
    };  
};
```

---

**List of properties**

The following properties can be specified in the iSF properties file:

---

**com.ionas.isp.adapters**

Specifies the iSF adapter type to be loaded by the Artix security service at runtime. Choosing a particular adapter type is equivalent to choosing an Artix security domain. Currently, you can specify one of the following adapter types:

- file
- LDAP
- krb5

For example, you can select the LDAP adapter as follows:

```
com.ionas.isp.adapters=LDAP
```

---

**com.ionas.isp.adapter.file.class**

Specifies the Java class that implements the file adapter.

For example, the default implementation of the file adapter provided with Artix is selected as follows:

```
com.ionas.isp.adapter.file.class=com.ionas.security.is2adapter.file.FileAuthAdapter
```

---

**com.ionas.isp.adapter.file.param.filename**

Specifies the name and location of a file that is used by the file adapter to store user authentication data.

For example, you can specify the file, `C:/is2_config/security_info.xml`, as follows:

```
com.ionas.isp.adapter.file.param.filename=C:/is2_config/security_info.xml
```

---

## com.iona.isp.adapter.file.param.userIDInCert

If an X.509 certificate is presented to the Artix security service for authentication, this property specifies which field from the certificate's subject DN is taken to be the user name.

The `userIDInCert` property can be set to any valid *attribute type*, where the attribute type identifies a field in a Distinguished Name (DN). See [“Attribute types” on page 734](#) for a partial list.

For example, to specify that the user name is taken from the Common Name (CN) from the certificate's subject DN, set the property as follows:

```
com.iona.isp.adapter.file.param.userIDInCert=CN
```

---

## com.iona.isp.adapter.file.params

*Obsolete.* This property was needed by earlier versions of the Artix security service, but is now ignored.

---

## com.iona.isp.adapter.krb5.class

Specifies the Java class that implements the Kerberos adapter.

For example, the default implementation of the Kerberos adapter provided with Artix is selected as follows:

```
com.iona.isp.adapter.krb5.class=com.iona.security.is2adapter.krb5.IS2KerberosAdapter
```

---

## com.iona.isp.adapter.krb5.param.check.kdc.principal

(Used in combination with the

`com.iona.isp.adapter.krb5.param.check.kdc.running` property.)

Specifies the dummy KDC principal that is used for connecting to the KDC server, in order to check whether it is running or not.

---

## `com.iona.isp.adapter.krb5.param.check.kdc.running`

A boolean property that specifies whether or not the Artix security service should check whether the Kerberos KDC server is running. Default is `false`.

---

## `com.iona.isp.adapter.krb5.param.ConnectTimeout.1`

Specifies the time-out interval for the connection to the Active Directory Server.

---

## `com.iona.isp.adapter.krb5.param.GroupBaseDN`

Specifies the base DN of the tree in the LDAP directory that stores user groups.

For example, you could use the RDN sequence, `DC=iona,DC=com`, as a base DN by setting this property as follows:

```
com.iona.isp.adapter.krb5.param.GroupBaseDN=dc=iona,dc=com
```

**Note:** The order of the RDNs is significant. The order should be based on the LDAP schema configuration.

---

## `com.iona.isp.adapter.krb5.param.GroupNameAttr`

Specifies the attribute type whose corresponding attribute value gives the name of the user group. The default is `CN`.

For example, you can use the common name, `CN`, attribute type to store the user group's name by setting this property as follows:

```
com.iona.isp.adapter.krb5.param.GroupNameAttr=cn
```

---

## com.iona.isp.adapter.krb5.param.GroupObjectClass

Specifies the object class that applies to user group entries in the LDAP directory structure. An object class defines the required and allowed attributes of an entry. The default is `groupOfUniqueNames`.

For example, to specify that all user group entries belong to the `groupOfWriters` object class:

```
com.iona.isp.adapter.krb5.param.GroupObjectClass=groupOfWriters
```

---

## com.iona.isp.adapter.krb5.param.GroupSearchScope

Specifies the group search scope. The search scope is the starting point of a search and the depth from the base DN to which the search should occur. This property can be set to one of the following values:

- `BASE`—Search a single entry (the base object).
- `ONE`—Search all entries immediately below the base DN.
- `SUB`—Search all entries from a whole subtree of entries.

Default is `SUB`.

For example, to search just the entries immediately below the base DN you would use the following:

```
com.iona.isp.adapter.krb5.param.GroupSearchScope=ONE
```

---

## com.iona.isp.adapter.krb5.param.host.1

Specifies the server name or IP address of the Active Directory Server used to retrieve a user's group information.

---

## **com.ionas.adapter.krb5.param.java.security.auth.login.config**

Specifies the JAAS login module configuration file. For example, if your JAAS login module configuration file is `jaas.config`, your Artix security service configuration would contain the following:

```
com.ionas.adapter.krb5.param.java.security.auth.login.config=jaas.conf
```

---

## **com.ionas.adapter.krb5.param.java.security.krb5.conf**

Specifies the location (path and file name) of the Kerberos configuration file, `krb5.conf`. In most cases, this configuration is not needed. For more information, see the [Java documentation](#) for Kerberos.

---

## **com.ionas.adapter.krb5.param.java.security.krb5.kdc**

Specifies the server name or IP address of the Kerberos KDC server.

---

## **com.ionas.adapter.krb5.param.java.security.krb5.realm**

Specifies the Kerberos Realm name.

For example, to specify that the Kerberos Realm is `is2.ionas.com` would require an entry similar to:

```
com.ionas.adapter.krb5.param.java.security.krb5.realm=is2.ionas.com
```

---

## **com.ionas.adapter.krb5.param.javax.security.auth.useSubjectCredsOnly**

This is a JAAS login module property that must be set to `false` when using Artix.



---

## com.ionas.adapter.krb5.param.MaxConnectionPoolSize

Specifies the maximum LDAP connection pool size for the Kerberos adapter (a strictly positive integer). The maximum connection pool size is the maximum number of LDAP connections that would be opened and cached by the Kerberos adapter. The default is 1.

For example, to limit the Kerberos adapter to open a maximum of 50 LDAP connections at a time:

```
com.ionas.adapter.krb5.param.MaxConnectionPoolSize=50
```

---

## com.ionas.adapter.krb5.param.MemberDNAttr

Specifies which LDAP attribute is used to retrieve group members. The Kerberos adapter uses the `MemberDNAttr` property to construct a query to find out which groups a user belongs to.

The list of the user's groups is needed to determine the complete set of roles assigned to the user. The LDAP adapter determines the complete set of roles assigned to a user as follows:

1. The adapter retrieves the roles assigned directly to the user.
2. The adapter finds out which groups the user belongs to, and retrieves all the roles assigned to those groups.

Default is `uniqueMember`.

For example, you can select the `uniqueMember` attribute as follows:

```
com.ionas.adapter.krb5.param.MemberDNAttr=uniqueMember
```

---

## com.ionas.adapter.krb5.param.MinConnectionPoolSize

Specifies the minimum LDAP connection pool size for the Kerberos adapter. The minimum connection pool size specifies the number of LDAP connections that are opened during initialization of the Kerberos adapter. The default is 1.

For example, to specify a minimum of 10 LDAP connections at a time:

```
com.ionas.adapter.krb5.param.MinConnectionPoolSize=10
```

---

## **com.iona.isp.adapter.krb5.param.port.1**

Specifies the port on which the Active Directory Server can be contacted.

---

## **com.iona.isp.adapter.krb5.param.PrincipalUserDN.1**

Specifies the username that is used to login to the Active Directory Server (in distinguished name format). This property need only be set if the Active Directory Server is configured to require username/password authentication.

---

## **com.iona.isp.adapter.krb5.param.PrincipalUserPassword.1**

Specifies the password that is used to login to the Active Directory Server. This property need only be set if the Active Directory Server is configured to require username/password authentication.

**WARNING:** Because the password is stored in plaintext, you must ensure that the `is2.properties` file is readable and writable only by users with administrator privileges.

---

## **com.iona.isp.adapter.krb5.param.RetrieveAuthInfo**

Specifies if the user's group information needs to be retrieved from the Active Directory Server. Default is `false`.

To instruct the Kerberos adapter to retrieve the user's group information, use the following:

```
com.iona.isp.adapter.krb5.param.RetrieveAuthInfo=true
```

---

## **com.iona.isp.adapter.krb5.param.RoleNameAttr**

Specifies the attribute type that the Kerberos server uses to store the role name. The default is `CN`.

For example, you can specify the common name, `cn`, attribute type as follows:

```
com.iona.isp.adapter.krb5.param.RoleNameAttr=cn
```

---

## **com.iona.isp.adapter.krb5.param.SSLCACertDir.1**

Specifies the directory name for trusted CA certificates. All certificate files in this directory are loaded and set as trusted CA certificates, for the purpose of opening an SSL connection to the Active Directory Server. The CA certificates can either be in DER-encoded X.509 format or in PEM-encoded X.509 format.

For example, to specify that the Kerberos adapter uses the `d:/certs/test` directory to store CA certificates:

```
com.iona.isp.adapter.krb5.param.SSLCACertDir.1=d:/certs/test
```

---

## **com.iona.isp.adapter.krb5.param.SSLClientCertFile.1**

Specifies the client certificate file that is used to identify the Artix security service to the Active Directory Server. This property is needed only if the Active Directory Server requires SSL/TLS mutual authentication. The certificate must be in PKCS#12 format.

## **com.iona.isp.adapter.krb5.param.SSLClientCertPassword.1**

Specifies the password for the client certificate that identifies the Artix security service to the Active Directory Server. This property is needed only if the Active Directory Server requires SSL/TLS mutual authentication.

**WARNING:** Because the password is stored in plaintext, you must ensure that the `is2.properties` file is readable and writable only by users with administrator privileges.

---

## com.iona.isp.adapter.krb5.param.SSLEnabled.1

Specifies if SSL is needed to connect with the Active Directory Server. The default is `no`.

To use SSL when contacting the Active Directory Server use the following:

```
com.iona.isp.adapter.krb5.param.SSLEnabled.1=yes
```

---

## com.iona.isp.adapter.krb5.param.sun.security.krb5.debug

Specifies a boolean value for the `sun.security.krb5.debug` debugging property. If `true`, Kerberos debugging output is generated. Default is `false`.

---

## com.iona.isp.adapter.krb5.param.UseGroupAsRole

Specifies whether a user's groups should be treated as roles. The following alternatives are available:

- `yes`—each group name is interpreted as a role name.
- `no`—for each of the user's groups, retrieve all roles assigned to the group.

This option is useful for some older directory structures, that do not have the role concept.

Default is `no`.

For example:

```
com.iona.isp.adapter.krb5.param.UseGroupAsRole=no
```

---

## com.iona.isp.adapter.krb5.param.UserBaseDN

Specifies the base DN (an ordered sequence of RDNs) of the tree in the active directory that stores user object class instances.

For example, you could use the RDN sequence, `DC=iona,DC=com`, as a base DN by setting this property as follows:

```
com.iona.isp.adapter.krb5.param.UserBaseDN=dc=iona,dc=com
```

---

## **com.iona.isp.adapter.krb5.param.UserCertAttrName**

Specifies the attribute type that stores a user certificate. The default is `userCertificate`.

For example, you can explicitly specify the attribute type for storing user certificates to be `userCertificate` as follows:

```
com.iona.isp.adapter.krb5.param.UserCertAttrName=userCertificate
```

---

## **com.iona.isp.adapter.krb5.param.UserNameAttr**

Specifies the attribute type whose corresponding value uniquely identifies the user. This is the attribute used as the user's login ID. The default is `uid`.

For example:

```
com.iona.isp.adapter.krb5.param.UserNameAttr=uid
```

---

## **com.iona.isp.adapter.krb5.param.UserObjectClass**

Specifies the attribute type for the object class that stores users. The default is `organizationalPerson`.

For example to set the class to `Person` you would use the following:

```
com.iona.isp.adapter.krb5.param.UserObjectClass=Person
```

---

## **com.iona.isp.adapter.krb5.param.UserRoleDNAttr**

Specifies the attribute type that stores a user's role DN. The default is `nsRoleDn` (from the Netscape LDAP directory schema).

For example:

```
com.iona.isp.adapter.krb5.param.UserRoleDNAttr=nsroledn
```

---

## com.iona.isp.adapter.krb5.param.UserSearchFilter

Custom filter for retrieving users. In the current version, `$USER_NAME$` is the only replaceable parameter supported. This parameter would be replaced during runtime by the LDAP adapter with the current User's login ID. This property uses the standard LDAP search filter syntax.

For example:

```
&(uid=$USER_NAME$(objectclass=organizationalPerson)
```

---

## com.iona.isp.adapter.krb5.param.version

Specifies the LDAP protocol version that the Kerberos adapter uses to communicate with the Active Directory Server. The only supported version is 3 (for LDAP v3, <http://www.ietf.org/rfc/rfc2251.txt>). The default is 3.

For example, to select the LDAP protocol version 3:

```
com.iona.isp.adapter.krb5.param.version=3
```

---

## com.iona.isp.adapter.LDAP.class

Specifies the Java class that implements the LDAP adapter.

For example, the default implementation of the LDAP adapter provided with Artix is selected as follows:

```
com.iona.isp.adapter.LDAP.class=com.iona.security.is2adapter.ldap.LdapAdapter
```

---

## com.iona.isp.adapter.LDAP.param.CacheSize

Specifies the maximum LDAP cache size in units of bytes. This maximum applies to the *total* LDAP cache size, including all LDAP connections opened by this Artix security service instance.

Internally, the Artix security service uses a third-party toolkit (currently the *iPlanet SDK*) to communicate with an LDAP server. The cache referred to here is one that is maintained by the LDAP third-party toolkit. Data retrieved from the LDAP server is temporarily stored in the cache in order to optimize subsequent queries.

For example, you can specify a cache size of 1000 as follows:

```
com.iona.isp.adapter.LDAP.param.CacheSize=1000
```

---

### **com.iona.isp.adapter.LDAP.param.CacheTimeToLive**

Specifies the LDAP cache time to-live in units of seconds. For example, you can specify a cache time to-live of one minute as follows:

```
com.iona.isp.adapter.LDAP.param.CacheTimeToLive=60
```

---

### **com.iona.isp.adapter.LDAP.param.GroupBaseDN**

Specifies the base DN of the tree in the LDAP directory that stores user groups.

For example, you could use the RDN sequence, `DC=iona,DC=com`, as a base DN by setting this property as follows:

```
com.iona.isp.adapter.LDAP.param.GroupBaseDN=dc=iona,dc=com
```

**Note:** The order of the RDNs is significant. The order should be based on the LDAP schema configuration.

---

### **com.iona.isp.adapter.LDAP.param.GroupNameAttr**

Specifies the attribute type whose corresponding attribute value gives the name of the user group. The default is `CN`.

For example, you can use the common name, `CN`, attribute type to store the user group's name by setting this property as follows:

```
com.iona.isp.adapter.LDAP.param.GroupNameAttr=cn
```

---

## com.iona.isp.adapter.LDAP.param.GroupObjectClass

Specifies the object class that applies to user group entries in the LDAP directory structure. An object class defines the required and allowed attributes of an entry. The default is `groupOfUniqueNames`.

For example, to specify that all user group entries belong to the `groupOfUniqueNames` object class:

```
com.iona.isp.adapter.LDAP.param.GroupObjectClass=groupofuniquenames
```

---

## com.iona.isp.adapter.LDAP.param.GroupSearchScope

Specifies the group search scope. The search scope is the starting point of a search and the depth from the base DN to which the search should occur. This property can be set to one of the following values:

- `BASE`—Search a single entry (the base object).
- `ONE`—Search all entries immediately below the base DN.
- `SUB`—Search all entries from a whole subtree of entries.

Default is `SUB`.

For example:

```
com.iona.isp.adapter.LDAP.param.GroupSearchScope=SUB
```

---

## com.iona.isp.adapter.LDAP.param.host.<cluster\_index>

For the `<cluster_index>` LDAP server replica, specifies the IP hostname where the LDAP server is running. The `<cluster_index>` is 1 for the primary server, 2 for the first failover replica, and so on.

For example, you could specify that the primary LDAP server is running on host `10.81.1.100` as follows:

```
com.iona.isp.adapter.LDAP.param.host.1=10.81.1.100
```



---

## **com.iona.isp.adapter.LDAP.param.MaxConnectionPoolSize**

Specifies the maximum LDAP connection pool size for the Artix security service (a strictly positive integer). The maximum connection pool size is the maximum number of LDAP connections that would be opened and cached by the Artix security service. The default is 1.

For example, to limit the Artix security service to open a maximum of 50 LDAP connections at a time:

```
com.iona.isp.adapter.LDAP.param.MaxConnectionPoolSize=50
```

---

## **com.iona.isp.adapter.LDAP.param.MemberDNAttr**

Specifies which LDAP attribute is used to retrieve group members. The LDAP adapter uses the `MemberDNAttr` property to construct a query to find out which groups a user belongs to.

The list of the user's groups is needed to determine the complete set of roles assigned to the user. The LDAP adapter determines the complete set of roles assigned to a user as follows:

1. The adapter retrieves the roles assigned directly to the user.
2. The adapter finds out which groups the user belongs to, and retrieves all the roles assigned to those groups.

Default is `uniqueMember`.

For example, you can select the `uniqueMember` attribute as follows:

```
com.iona.isp.adapter.LDAP.param.MemberDNAttr=uniqueMember
```

---

## **com.iona.isp.adapter.LDAP.param.MemberFilter**

Specifies how to search for members in a group. The value specified for this property must be an LDAP search filter (can be a custom filter).

---

## **com.iona.isp.adapter.LDAP.param.MinConnectionPoolSize**

Specifies the minimum LDAP connection pool size for the Artix security service. The minimum connection pool size specifies the number of LDAP connections that are opened during initialization of the Artix security service. The default is 1.

For example, to specify a minimum of 10 LDAP connections at a time:

```
com.iona.isp.adapter.LDAP.param.MinConnectionPoolSize=10
```

---

## **com.iona.isp.adapter.LDAP.param.port.<cluster\_index>**

For the <cluster\_index> LDAP server replica, specifies the IP port where the LDAP server is listening. The <cluster\_index> is 1 for the primary server, 2 for the first failover replica, and so on. The default is 389.

For example, you could specify that the primary LDAP server is listening on port 636 as follows:

```
com.iona.isp.adapter.LDAP.param.port.1=636
```

---

## **com.iona.isp.adapter.LDAP.param.PrincipalUserDN.<cluster\_index>**

For the <cluster\_index> LDAP server replica, specifies the username that is used to login to the LDAP server (in distinguished name format). This property need only be set if the LDAP server is configured to require username/password authentication.

No default.

---

## **com.iona.isp.adapter.LDAP.param.PrincipalUserPassword.<cluster\_index>**

For the <cluster\_index> LDAP server replica, specifies the password that is used to login to the LDAP server. This property need only be set if the LDAP server is configured to require username/password authentication.

No default.

**WARNING:** Because the password is stored in plaintext, you must ensure that the `is2.properties` file is readable and writable only by users with administrator privileges.

---

## **com.iona.isp.adapter.LDAP.param.RetrieveAuthInfo**

Specifies whether or not the Artix security service retrieves authorization information from the LDAP server. This property selects one of the following alternatives:

- `yes`—the Artix security service retrieves authorization information from the LDAP server.
- `no`—the Artix security service retrieves authorization information from the iS2 authorization manager..

Default is `no`.

For example, to use the LDAP server's authorization information:

```
com.iona.isp.adapter.LDAP.param.RetrieveAuthInfo=yes
```

---

## **com.iona.isp.adapter.LDAP.param.RoleNameAttr**

Specifies the attribute type that the LDAP server uses to store the role name. The default is `cn`.

For example, you can specify the common name, `cn`, attribute type as follows:

```
com.iona.isp.adapter.LDAP.param.RoleNameAttr=cn
```

---

## **com.iona.isp.adapter.LDAP.param.SSLCACertDir.<cluster\_index>**

For the `<cluster_index>` LDAP server replica, specifies the directory name for trusted CA certificates. All certificate files in this directory are loaded and set as trusted CA certificates, for the purpose of opening an SSL connection to the LDAP server. The CA certificates can either be in DER-encoded X.509 format or in PEM-encoded X.509 format.

No default.

For example, to specify that the primary LDAP server uses the `d:/certs/test` directory to store CA certificates:

```
com.iona.isp.adapter.LDAP.param.SSLCACertDir.1=d:/certs/test
```

---

### **com.iona.isp.adapter.LDAP.param.SSLClientCertFile.***<cluster\_index>*

Specifies the client certificate file that is used to identify the Artix security service to the *<cluster\_index>* LDAP server replica. This property is needed only if the LDAP server requires SSL/TLS mutual authentication. The certificate must be in PKCS#12 format.

No default.

---

### **com.iona.isp.adapter.LDAP.param.SSLClientCertPassword.***<cluster\_index>*

Specifies the password for the client certificate that identifies the Artix security service to the *<cluster\_index>* LDAP server replica. This property is needed only if the LDAP server requires SSL/TLS mutual authentication.

**WARNING:** Because the password is stored in plaintext, you must ensure that the `is2.properties` file is readable and writable only by users with administrator privileges.

---

### **com.iona.isp.adapter.LDAP.param.SSLEnabled.***<cluster\_index>*

Enables SSL/TLS security for the connection between the Artix security service and the *<cluster\_index>* LDAP server replica. The possible values are `yes` or `no`. Default is `no`.

For example, to enable an SSL/TLS connection to the primary LDAP server:

```
com.iona.isp.adapter.LDAP.param.SSLEnabled.1=yes
```

---

## **com.iona.isp.adapter.LDAP.param.UseGroupAsRole**

Specifies whether a user's groups should be treated as roles. The following alternatives are available:

- `yes`—each group name is interpreted as a role name.
- `no`—for each of the user's groups, retrieve all roles assigned to the group.

This option is useful for some older versions of LDAP, such as iPlanet 4.0, that do not have the role concept.

Default is `no`.

For example:

```
com.iona.isp.adapter.LDAP.param.UseGroupAsRole=no
```

---

## **com.iona.isp.adapter.LDAP.param.UserBaseDN**

Specifies the base DN (an ordered sequence of RDNs) of the tree in the LDAP directory that stores user object class instances.

For example, you could use the RDN sequence, `DC=iona,DC=com`, as a base DN by setting this property as follows:

```
com.iona.isp.adapter.LDAP.param.UserBaseDN=dc=iona,dc=com
```

---

## **com.iona.isp.adapter.LDAP.param.UserCertAttrName**

Specifies the attribute type that stores a user certificate. The default is `userCertificate`.

For example, you can explicitly specify the attribute type for storing user certificates to be `userCertificate` as follows:

```
com.iona.isp.adapter.LDAP.param.UserCertAttrName=userCertificate
```

---

## **com.iona.isp.adapter.LDAP.param.UserNameAttr=uid**

Specifies the attribute type whose corresponding value uniquely identifies the user. This is the attribute used as the user's login ID. The default is `uid`.  
For example:

```
com.iona.isp.adapter.LDAP.param.UserNameAttr=uid
```

---

## **com.iona.isp.adapter.LDAP.param.UserObjectClass**

Specifies the attribute type for the object class that stores users. The default is `organizationalPerson`.

For example:

```
com.iona.isp.adapter.LDAP.param.UserObjectClass=organizationalPerson
```

---

## **com.iona.isp.adapter.LDAP.param.UserRoleDNAttr**

Specifies the attribute type that stores a user's role DN. The default is `nsRoleDn` (from the Netscape LDAP directory schema).

For example:

```
com.iona.isp.adapter.LDAP.param.UserRoleDNAttr=nsroledn
```

---

## **com.iona.isp.adapter.LDAP.param.UserSearchFilter**

Custom filter for retrieving users. In the current version, `$USER_NAME$` is the only replaceable parameter supported. This parameter would be replaced during runtime by the LDAP adapter with the current User's login ID. This property uses the standard LDAP search filter syntax.

For example:

```
&(uid=$USER_NAME$)(objectclass=organizationalPerson)
```

---

## com.iona.isp.adapter.LDAP.param.UserSearchScope

Specifies the user search scope. This property can be set to one of the following values:

- `BASE`—Search a single entry (the base object).
- `ONE`—Search all entries immediately below the base DN.
- `SUB`—Search all entries from a whole subtree of entries.

Default is `SUB`.

For example:

```
com.iona.isp.adapter.LDAP.param.UserSearchScope=SUB
```

---

## com.iona.isp.adapter.LDAP.param.version

Specifies the LDAP protocol version that the Artix security service uses to communicate with LDAP servers. The only supported version is 3 (for LDAP v3, <http://www.ietf.org/rfc/rfc2251.txt>). The default is 3.

For example, to select the LDAP protocol version 3:

```
com.iona.isp.adapter.LDAP.param.version=3
```

---

## com.iona.isp.adapter.LDAP.params

*Obsolete.* This property was needed by earlier versions of the Artix security service, but is now ignored.

---

## com.iona.isp.authz.adapters

Specifies the name of the adapter that is loaded to perform authorization. The adapter name is an arbitrary identifier, *AdapterName*, which is used to construct the names of the properties that configure the adapter—that is, `com.iona.isp.authz.adapter.AdapterName.class` and `com.iona.isp.authz.adapter.AdapterName.param.filelist`. For example:

```
com.iona.isp.authz.adapters=file
com.iona.isp.authz.adapter.file.class=com.iona.security.is2AzAdapter.multifile.MultiFileAzAdapter
com.iona.isp.authz.adapter.file.param.filelist=ACLFileListFile;
```

---

### com.iona.isp.authz.adapter.*AdapterName*.class

Selects the authorization adapter class for the *AdapterName* adapter. The following adapter implementations are provided by Orbix:

- `com.iona.security.is2AzAdapter.multifile.MultiFileAzAdapter`—an authorization adapter that enables you to specify multiple ACL files. It is used in conjunction with the `com.iona.isp.authz.adapter.file.param.filelist` property.

For example:

```
com.iona.isp.authz.adapters = file
com.iona.isp.authz.adapter.file.class=com.iona.security.is2AzAdapter.multifile.MultiFileAzAdapter
```

---

### com.iona.isp.authz.adapter.*AdapterName*.param.filelist

Specifies the absolute pathname of a file containing a list of ACL files for the *AdapterName* adapter. Each line of the specified file has the following format:

```
[ACLKey=]ACLFileName
```



A file name can optionally be preceded by an ACL key and an equals sign, *ACLKey=*, if you want to select the file by ACL key. The ACL file, *ACLFileName*, is specified using an absolute pathname in the local file format.

For example, on Windows you could specify a list of ACL files as follows:

```
U:/orbix_security/etc/acl_files/server_A.xml
U:/orbix_security/etc/acl_files/server_B.xml
U:/orbix_security/etc/acl_files/server_C.xml
```

---

## is2.current.server.id

The server ID is an alphanumeric string (excluding spaces) that specifies the current Orbix security service's ID. The server ID is needed for clustering. When a secure application obtains a single sign-on (SSO) token from this Orbix security service, the server ID is embedded into the SSO token. Subsequently, if the SSO token is passed to a *second* Orbix security service instance, the second Orbix security service recognizes that the SSO token originates from the first Orbix security service and delegates security operations to the first Orbix security service.

The server ID is also used to identify replicas in the `cluster.properties` file.

For example, to assign a server ID of `1` to the current Orbix security service:

```
is2.current.server.id=1
```

---

## is2.cluster.properties.filename

Specifies the file that stores the configuration properties for clustering. For example:

```
is2.cluster.properties.filename=C:/is2_config/cluster.properties
```

---

## is2.replication.required

Enables the replication feature of the Artix security service, which can be used in the context of security service clustering. The possible values are `true` (enabled) and `false` (disabled). When replication is enabled, the security service pushes its cache of SSO data to other servers in the cluster at regular intervals.

Default is `false`.

For example:

```
is2.replication.required=true
```

---

## is2.replication.interval

Specifies the time interval between replication updates to other servers in the security service cluster. The value is specified in units of a second.

Default is 30 seconds.

For example:

```
is2.replication.interval=10
```

---

## is2.replica.selector.classname

If replication is enabled (see `is2.replication.required`), you must set this variable equal to `com.ionasecurity.replicate.StaticReplicaSelector`.

For example:

```
is2.replica.selector.classname=com.ionasecurity.replicate.StaticReplicaSelector
```

---

## is2.sso.cache.size

Specifies the maximum cache size (number of user sessions) associated with single sign-on (SSO) feature. The SSO caches user information, including the user's group and role information. If the maximum cache size is reached, the oldest sessions are deleted from the session cache.

Default is 10000.

For example:

```
is2.sso.cache.size=1000
```

---

## is2.sso.enabled

Enables the single sign-on (SSO) feature of the Artix security service. The possible values are `yes` (enabled) and `no` (disabled).

Default is `yes`.

For example:

```
is2.sso.enabled=yes
```

---

## is2.sso.remote.token.cached

In a federated scenario, this variable enables caching of token data for tokens that originate from another security service in the federated cluster. When this variable is set to `true`, a security service need contact another security service in the cluster, only when the remote token is authenticated for the first time. For subsequent token authentications, the token data for the remote token can be retrieved from the local cache.

Default is `false`.

---

## is2.sso.session.idle.timeout

Sets the session idle time-out in units of seconds for the single sign-on (SSO) feature of the Artix security service. A zero value implies no time-out. If a user logs on to the Artix Security Framework (supplying username and password) with SSO enabled, the Artix security service returns an SSO token for the user. The next time the user needs to access a resource, there is no need to log on again because the SSO token can be used instead. However, if no secure operations are performed using the SSO token for the length of time specified in the idle time-out, the SSO token expires and the user must log on again.

Default is 0 (no time-out).

For example:

```
is2.sso.session.idle.timeout=0
```

---

## is2.sso.session.timeout

Sets the absolute session time-out in units of seconds for the single sign-on (SSO) feature of the Artix security service. A zero value implies no time-out. This is the maximum length of time since the time of the original user login for which an SSO token remains valid. After this time interval elapses, the session expires irrespective of whether the session has been active or idle. The user must then login again.

Default is 0 (no time-out).

For example:

```
is2.sso.session.timeout=0
```

---

## log4j.configuration

Specifies the log4j configuration filename. You can use the properties in this file to customize the level of debugging output from the Artix security service. See also [“log4j Properties File” on page 728](#).

For example:

```
log4j.configuration=d:/temp/myconfig.txt
```

---

# Cluster Properties File

---

## Overview

The cluster properties file is used to store properties common to a group of Artix security service instances that operate as a cluster or federation. This section provides descriptions of all the properties that can be specified in a cluster file.

---

## File location

The location of the cluster properties file is specified by the `is2.cluster.properties.filename` property in the iSF properties file. All of the Artix security service instances in a cluster or federation must share the same cluster properties file.

---

## List of properties

The following properties can be specified in the cluster properties file:

---

### **`com.iona.security.common.securityInstanceURL.<server_ID>`**

Specifies the server URL for the `<server_ID>` Artix security service instance. When single sign-on (SSO) is enabled together with clustering or federation, the Artix security service instances use the specified instance URLs to communicate with each other. By specifying the URL for a particular Artix security service instance, you are instructing the instance to listen for messages at that URL. Because the Artix security service instances share the same cluster file, they can read each other's URLs and open connections to each other.

The connections between Artix security service instances can either be insecure (HTTP) or secure (HTTPS). To enable SSL/TLS security, use the `https:` prefix in each of the instance URLs.

For example, to configure two Artix security service instances to operate in a cluster or federation using *insecure* communications (HTTP):

```
com.iona.security.common.securityInstanceURL.1=http://localhost:8080/isp/AuthService
com.iona.security.common.securityInstanceURL.2=http://localhost:8081/isp/AuthService
```

Alternatively, to configure two Artix security service instances to operate in a cluster or federation using *secure* communications (HTTPS):

```
com.iona.security.common.securityInstanceURL.1=https://localhost:8080/isp/AuthService
com.iona.security.common.securityInstanceURL.2=https://localhost:8081/isp/AuthService
```

In the secure case, you must also configure the certificate-related cluster properties (described in this section) for each Artix security service instance.

---

### **com.iona.security.common.replicaURL.<server\_ID>**

A comma-separated list of URLs for the other security services to which this service replicates its SSO token data.

---

### **com.iona.security.common.cACertDir.<server\_ID>**

For the <server\_ID> Artix security service instance in a HTTPS cluster or federation, specifies the directory containing trusted CA certificates. The CA certificates can either be in DER-encoded X.509 format or in PEM-encoded X.509 format.

For example, to specify `d:/temp/cert` as the CA certificate directory for the primary Artix security service instance:

```
com.iona.security.common.cACertDir.1=d:/temp/cert
```

---

### **com.iona.security.common.clientCertFileName.<server\_ID>**

For the <server\_ID> Artix security service instance in a HTTPS cluster or federation, specifies the client certificate file that identifies the Artix security service to its peers within a cluster or federation. The certificate must be in PKCS#12 format.

---

### **com.iona.security.common.clientCertPassword.<server\_ID>**

For the <server\_ID> Artix security service instance in a HTTPS cluster or federation, specifies the password for the client certificate that identifies the Artix security service to its peers within a cluster or federation.

**WARNING:** Because the password is stored in plaintext, you must ensure that the `is2.properties` file is readable and writable only by users with administrator privileges.

---

# log4j Properties File

---

## Overview

The log4j properties file configures log4j logging for your Artix security service. This section describes a minimal set of log4j properties that can be used to configure basic logging.

## log4j documentation

For complete log4j documentation, see the following Web page:  
<http://jakarta.apache.org/log4j/docs/documentation.html>

## File location

The location of the log4j properties file is specified by the `log4j.configuration` property in the iSF properties file. For ease of administration, different Artix security service instances can optionally share a common log4j properties file.

## List of properties

To give you some idea of the capabilities of log4j, the following is an incomplete list of properties that can be specified in a log4j properties file:

### log4j.appender.<AppenderHandle>

This property specifies a log4j appender class that directs <AppenderHandle> logging messages to a particular destination. For example, one of the following standard log4j appender classes could be specified:

- `org.apache.log4j.ConsoleAppender`
- `org.apache.log4j.FileAppender`
- `org.apache.log4j.RollingFileAppender`
- `org.apache.log4j.DailyRollingFileAppender`
- `org.apache.log4j.AsynchAppender`
- `org.apache.log4j.WriterAppender`

For example, to log messages to the console screen for the `A1` appender handle:

```
log4j.appender.A1=org.apache.log4j.ConsoleAppender
```



---

## log4j.appender.<AppenderHandle>.layout

This property specifies a log4j layout class that is used to format <AppenderHandle> logging messages. One of the following standard log4j layout classes could be specified:

- org.apache.log4j.PatternLayout
- org.apache.log4j.HTMLLayout
- org.apache.log4j.SimpleLayout
- org.apache.log4j.TTCCLayout

For example, to use the pattern layout class for log messages processed by the A1 appender:

```
log4j.appender.A1.layout=org.apache.log4j.PatternLayout
```

---

## log4j.appender.<AppenderHandle>.layout.ConversionPattern

This property is used only in conjunction with the org.apache.log4j.PatternLayout class (when specified by the log4j.appender.<AppenderHandle>.layout property) to define the format of a log message.

For example, you can specify a basic conversion pattern for the A1 appender as follows:

```
log4j.appender.A1.layout.ConversionPattern=%-4r [%t] %-5p %c %x - %m%n
```

---

## log4j.rootCategory

This property is used to specify the logging level of the root logger and to associate the root logger with one or more appenders. The value of this property is specified as a comma separated list as follows:

```
<LogLevel>, <AppenderHandle01>, <AppenderHandle02>, ...
```

The logging level, <LogLevel>, can have one of the following values:

- DEBUG
- INFO
- WARN
- ERROR

- FATAL

An appender handle is an arbitrary identifier that associates a logger with a particular logging destination.

For example, to select all messages at the `DEBUG` level and direct them to the `A1` appender, you can set the property as follows:

```
log4j.rootCategory=DEBUG, A1
```

# ASN.1 and Distinguished Names

*The OSI Abstract Syntax Notation One (ASN.1) and X.509 Distinguished Names play an important role in the security standards that define X.509 certificates and LDAP directories.*

---

## In this appendix

This appendix contains the following section:

<a href="#">ASN.1</a>	<a href="#">page 732</a>
<a href="#">Distinguished Names</a>	<a href="#">page 733</a>

# ASN.1

---

## Overview

The *Abstract Syntax Notation One* (ASN.1) was defined by the OSI standards body in the early 1980s to provide a way of defining data types and structures that is independent of any particular machine hardware or programming language. In many ways, ASN.1 can be considered a forerunner of the OMG's IDL, because both languages are concerned with defining platform-independent data types.

ASN.1 is important, because it is widely used in the definition of standards (for example, SNMP, X.509, and LDAP). In particular, ASN.1 is ubiquitous in the field of security standards—the formal definitions of X.509 certificates and distinguished names are described using ASN.1 syntax. You do not require detailed knowledge of ASN.1 syntax to use these security standards, but you need to be aware that ASN.1 is used for the basic definitions of most security-related data types.

---

## BER

The OSI's Basic Encoding Rules (BER) define how to translate an ASN.1 data type into a sequence of octets (binary representation). The role played by BER with respect to ASN.1 is, therefore, similar to the role played by GIOP with respect to the OMG IDL.

---

## DER

The OSI's Distinguished Encoding Rules (DER) are a specialization of the BER. The DER consists of the BER plus some additional rules to ensure that the encoding is unique (BER encodings are not).

---

## References

You can read more about ASN.1 in the following standards documents:

- ASN.1 is defined in X.208.
- BER is defined in X.209.

---

# Distinguished Names

---

## Overview

Historically, distinguished names (DN) were defined as the primary keys in an X.500 directory structure. In the meantime, however, DNs have come to be used in many other contexts as general purpose identifiers. In the Artix Security Framework, DNs occur in the following contexts:

- X.509 certificates—for example, one of the DNs in a certificate identifies the owner of the certificate (the security principal).
- LDAP—DNs are used to locate objects in an LDAP directory tree.

## String representation of DN

Although a DN is formally defined in ASN.1, there is also an LDAP standard that defines a UTF-8 string representation of a DN (see [RFC 2253](#)). The string representation provides a convenient basis for describing the structure of a DN.

**Note:** The string representation of a DN does *not* provide a unique representation of DER-encoded DN. Hence, a DN that is converted from string format back to DER format does not always recover the original DER encoding.

## DN string example

The following string is a typical example of a DN:

```
C=US,O=IONA Technologies,OU=Engineering,CN=A. N. Other
```

## Structure of a DN string

A DN string is built up from the following basic elements:

- [OID](#).
- [Attribute types](#).
- [AVA](#).
- [RDN](#).

## OID

An OBJECT IDENTIFIER (OID) is a sequence of bytes that uniquely identifies a grammatical construct in ASN.1.

**Attribute types**

The variety of attribute types that could appear in a DN is theoretically open-ended, but in practice only a small subset of attribute types are used. [Table 21](#) shows a selection of the attribute types that you are most likely to encounter:

**Table 21:** *Commonly Used Attribute Types*

String Representation	X.500 Attribute Type	Size of Data	Equivalent OID
C	countryName	2	2.5.4.6
O	organizationName	1...64	2.5.4.10
OU	organizationalUnitName	1...64	2.5.4.11
CN	commonName	1...64	2.5.4.3
ST	stateOrProvinceName	1...64	2.5.4.8
L	localityName	1...64	2.5.4.7
STREET	streetAddress		
DC	domainComponent		
UID	userid		

**AVA**

An *attribute value assertion* (AVA) assigns an attribute value to an attribute type. In the string representation, it has the following syntax:

```
<attr-type>=<attr-value>
```

For example:

```
CN=A. N. Other
```

Alternatively, you can use the equivalent OID to identify the attribute type in the string representation (see [Table 21](#)). For example:

```
2.5.4.3=A. N. Other
```

**RDN**

---

A *relative distinguished name* (RDN) represents a single node of a DN (the bit that appears between the commas in the string representation).

Technically, an RDN might contain more than one AVA (it is formally defined as a set of AVAs); in practice, however, this almost never occurs. In the string representation, an RDN has the following syntax:

```
<attr-type>=<attr-value>[+<attr-type>=<attr-value> ...]
```

Here is an example of a (very unlikely) multiple-value RDN:

```
OU=Eng1+OU=Eng2+OU=Eng3
```

Here is an example of a single-value RDN:

```
OU=Engineering
```





# Action-Role Mapping DTD

*This appendix presents the document type definition (DTD) for the action-role mapping XML file.*

---

## DTD file

The action-role mapping DTD is shown in [Example 144](#).

### Example 144:

```
<?xml version="1.0" encoding="UTF-8"?>
<!ELEMENT action-name (#PCDATA)>
<!ELEMENT role-name (#PCDATA)>
<!ELEMENT server-name (#PCDATA)>
<!ELEMENT action-role-mapping (server-name, interface+)>
<!ELEMENT name (#PCDATA)>
<!ELEMENT interface (name, action-role+)>
<!ELEMENT action-role (action-name, role-name+)>
<!ELEMENT allow-unlisted-interfaces (#PCDATA)>
<!ELEMENT secure-system (allow-unlisted-interfaces*,
    action-role-mapping+)>
```

**Action-role mapping elements**

The elements of the action-role mapping DTD can be described as follows:

```
<!ELEMENT action-name (#PCDATA)>
```

Specifies the action name to which permissions are assigned. The interpretation of the action name depends on the type of application:

- ◆ CORBA server—for IDL operations, the action name corresponds to the GIOP on-the-wire format of the operation name (usually the same as it appears in IDL).  
For IDL attributes, the accessor or modifier action name corresponds to the GIOP on-the-wire format of the attribute accessor or modifier. For example, an IDL attribute, `foo`, would have an accessor, `_get_foo`, and a modifier, `_set_foo`.
- ◆ Artix server—for WSDL operations, the action name is equivalent to a WSDL operation name; that is, the *OperationName* from a tag, `<operation name="OperationName">`.

The `action-name` element supports a wildcard mechanism, where the special character, `*`, can be used to match any number of contiguous characters in an action name. For example, the following `action-name` element matches any action:

```
<action-name>*</action-name>
```

```
<!ELEMENT action-role (action-name, role-name+)>
```

Groups together a particular action and all of the roles permitted to perform that action.

```
<!ELEMENT action-role-mapping (server-name, interface+)>
```

Contains all of the permissions that apply to a particular server application.

<!ELEMENT allow-unlisted-interfaces (#PCDATA)>

Specifies the default access permissions that apply to interfaces not explicitly listed in the action-role mapping file. The element contents can have the following values:

- ◆ `true`—for any interfaces not listed, access to all of the interfaces' actions is allowed for all roles. If the remote user is unauthenticated (in the sense that no credentials are sent by the client), access is also allowed.

**Note:** However, if `<allow-unlisted-interfaces>` is `true` and a particular interface is listed, then only the actions explicitly listed within that interface's `interface` element are accessible. Unlisted actions from the listed interface are not accessible.

- ◆ `false`—for any interfaces not listed, access to all of the interfaces' actions is denied for all roles. Unauthenticated users are also denied access.

Default is `false`.

<!ELEMENT interface (name, action-role+)>

In the case of a CORBA server, the `interface` element contains all of the access permissions for one particular IDL interface.

In the case of an Artix server, the `interface` element contains all of the access permissions for one particular WSDL port type.

<!ELEMENT name (#PCDATA)>

Within the scope of an `interface` element, identifies the interface (IDL interface or WSDL port type) with which permissions are being associated. The format of the interface name depends on the type of application, as follows:

- ◆ CORBA server—the `name` element identifies the IDL interface using the interface's OMG repository ID. The repository ID normally consists of the characters `IDL:` followed by the fully scoped name of the interface (using `/` instead of `::` as the scoping

character), followed by the characters `:1.0`. Hence, the `Simple::SimpleObject` IDL interface is identified by the `IDL:Simple/SimpleObject:1.0` repository ID.

**Note:** The form of the repository ID can also be affected by various `#pragma` directives appearing in the IDL file. A commonly used directive is `#pragma prefix`.

For example, the `CosNaming::NamingContext` interface in the naming service module, which uses the `omg.org` prefix, has the following repository ID: `IDL:omg.org/CosNaming/NamingContext:1.0`

- ◆ Artix server—the `name` element contains a WSDL port type name, specified in the following format:

*NamespaceURI:PortTypeName*

The *PortTypeName* comes from a tag, `<portType name="PortTypeName">`, defined in the *NamespaceURI* namespace.

The *NamespaceURI* is usually defined in the `<definitions targetNamespace="NamespaceURI" ...>` tag of the WSDL contract.

The `name` element supports a wildcard mechanism, where the special character, `*`, can be used to match any number of contiguous characters in an interface name. For example, the following `name` element matches any interface:

```
<interface>
  <name>*</name>
  ...
</interface>
```

`<!ELEMENT role-name (#PCDATA)>`

Specifies a role to which permission is granted. The role name can be any role that belongs to the server's Artix authorization realm (for CORBA bindings, the realm name is specified by the `plugins:gsp:authorization_realm` configuration variable; for SOAP bindings, the realm name is specified by the `plugins:asp:authorization_realm` configuration variable) or to the `IONAGlobalRealm` realm. The roles themselves are defined in the

security server backend; for example, in a file adapter file or in an LDAP backend.

```
<!ELEMENT secure-system (allow-unlisted-interfaces*,  
action-role-mapping+)>
```

The outermost scope of an action-role mapping file groups together a collection of `action-role-mapping` elements.

```
<!ELEMENT server-name (#PCDATA)>
```

The `server-name` element specifies the configuration scope (that is, the ORB name or BUS name) used by the server in question. This is normally the value of the `-ORBname` or `-BUSname` parameter passed to the server executable on the command line.

The `server-name` element supports a wildcard mechanism, where the special character, `*`, can be used to match any number of contiguous characters in an ORB name or BUS name. For example, the following `server-name` element matches any ORB name or BUS name:

```
<server-name>*</server-name>
```



# OpenSSL Utilities

*The `openssl` program consists of a large number of utilities that have been combined into one program. This appendix describes how you use the `openssl` program with Artix when managing X.509 certificates and private keys.*

---

**In this appendix**

This appendix contains the following sections:

<a href="#">Using OpenSSL Utilities</a>	page 744
<a href="#">The OpenSSL Configuration File</a>	page 758

---

# Using OpenSSL Utilities

---

## The OpenSSL package

This section describes a version of the `openssl` program that is available with Eric Young's OpenSSL package, which you can download from the OpenSSL Web site, <http://www.openssl.org>. OpenSSL is a publicly available implementation of the SSL protocol. Consult "License Issues" on page 773 for information about the copyright terms of OpenSSL.

**Note:** For complete documentation of the OpenSSL utilities, consult the documentation at the OpenSSL web site <http://www.openssl.org/docs>.

---

## Command syntax

An `openssl` command line takes the following form:

```
openssl utility arguments
```

For example:

```
openssl x509 -in OrbixCA -text
```

---

## The `openssl` utilities

This appendix describes the following `openssl` utilities:

<code>x509</code>	Manipulates X.509 certificates.
<code>req</code>	Creates and manipulates certificate signing requests, and self-signed certificates.
<code>rsa</code>	Manipulates RSA private keys.
<code>ca</code>	Implements a Certification Authority (CA).
<code>s_client</code>	Implements a generic SSL/TLS client.
<code>s_server</code>	Implements a generic SSL/TLS server.

---

## The `-help` option

To get a list of the arguments associated with a particular command, use the `-help` option as follows:

```
openssl utility -help
```

For example:

```
openssl x509 -help
```



---

## The x509 Utility

---

### Purpose of the `x509` utility

In Artix the `x509` utility is mainly used for:

- Printing text details of certificates you wish to examine.
  - Converting certificates to different formats.
- 

### Options

The options supported by the `openssl x509` utility are as follows:

```
-inform arg          - input format - default PEM
                    (one of DER, NET or PEM)
-outform arg        - output format - default PEM
                    (one of DER, NET or PEM)
-keyform arg        - private key format - default PEM
-CAform arg         - CA format - default PEM
-CAkeyform arg      - CA key format - default PEM
-in arg             - input file - default stdin
-out arg            - output file - default stdout
-serial             - print serial number value
-hash               - print serial number value
-subject            - print subject DN
-issuer             - print issuer DN
-startdate          - notBefore field
-enddate            - notAfter field
-dates              - both Before and After dates
-modulus            - print the RSA key modulus
-fingerprint        - print the certificate fingerprint
-noout              - no certificate output
-days arg           - How long till expiry of a signed certificate
                    - def 30 days
-signkey arg        - self sign cert with arg
-x509toreq          - output a certification request object
-req                - input is a certificate request, sign and
                    output
-CA arg             - set the CA certificate, must be PEM format
```

```

-CAkey arg          - set the CA key, must be PEM format. If missing
                    it is assumed to be in the CA file
-CAcreateserial    - create serial number file if it does not exist
-CAserial          - serial file
-text              - print the certificate in text form
-C                 - print out C code forms
-md2/-md5/-sha1/  - digest to do an RSA sign with
-mdc2

```

---

### Using the x509 utility

To print the text details of an existing PEM-format X.509 certificate, use the `x509` utility as follows:

```
openssl x509 -in MyCert.pem -inform PEM -text
```

To print the text details of an existing DER-format X.509 certificate, use the `x509` utility as follows:

```
openssl x509 -in MyCert.der -inform DER -text
```

To change a certificate from PEM format to DER format, use the `x509` utility as follows:

```
openssl x509 -in MyCert.pem -inform PEM -outform DER -out
    MyCert.der
```

---

## The req Utility

---

### Purpose of the `x509` utility

The `req` utility is used to generate a self-signed certificate or a certificate signing request (CSR). A CSR contains details of a certificate to be issued by a CA. When creating a CSR, the `req` command prompts you for the necessary information from which a certificate request file and an encrypted private key file are produced. The certificate request is then submitted to a CA for signing.

If the `-nodes` (no DES) parameter is not supplied to `req`, you are prompted for a pass phrase which will be used to protect the private key.

**Note:** It is important to specify a validity period (using the `-days` parameter). If the certificate expires, applications that are using that certificate will not be authenticated successfully.

### Options

The options supported by the `openssl req` utility are as follows:

```
-inform arg          input format - one of DER TXT PEM
-outform            arg output format - one of DER TXT PEM
-in arg            inout file
-out arg           output file
-text              text form of request
-noout             do not output REQ
-verify            verify signature on REQ
-modulus           RSA modulus
-nodes             do not encrypt the output key
-key file          use the private key contained in file
-keyform arg       key file format
-keyout arg        file to send the key to
-newkey rsa:bits   generate a new RSA key of 'bits' in size
-newkey dsa:file   generate a new DSA key, parameters taken from
                  CA in 'file'
-[digest]          Digest to sign with (md5, sha1, md2, mdc2)
-config file       request template file
```

<code>-new</code>	new request
<code>-x509</code>	output an x509 structure instead of a certificate req. (Used for creating self signed certificates)
<code>-days</code>	number of days an x509 generated by <code>-x509</code> is valid for
<code>-asn1-kludge</code>	Output the 'request' in a format that is wrong but some CA's have been reported as requiring [It is now always turned on but can be turned off with <code>-no-asn1-kludge</code> ]

---

### Using the req Utility

To create a self-signed certificate with an expiry date a year from now, the `req` utility can be used as follows to create the certificate `CA_cert.pem` and the corresponding encrypted private key file `CA_pk.pem`:

```
openssl req -config ssl_conf_path_name -days 365
-out CA_cert.pem -new -x509 -keyout CA_pk.pem
```

This following command creates the certificate request `MyReq.pem` and the corresponding encrypted private key file `MyEncryptedKey.pem`:

```
openssl req -config ssl_conf_path_name -days 365
-out MyReq.pem -new -keyout MyEncryptedKey.pem
```

---

## The rsa Utility

### Purpose of the `rsa` utility

The `rsa` command is a useful utility for examining and modifying RSA private key files. Generally RSA keys are stored encrypted with a symmetric algorithm using a user-supplied pass phrase. The OpenSSL `req` command prompts the user for a pass phrase in order to encrypt the private key. By default, `req` uses the triple DES algorithm. The `rsa` command can be used to change the password that protects the private key and to convert the format of the private key. Any `rsa` command that involves reading an encrypted `rsa` private key will prompt for the PEM pass phrase used to encrypt it.

### Options

The options supported by the `openssl rsa` utility are as follows:

<code>-inform arg</code>	input format - one of DER NET PEM
<code>-outform arg</code>	output format - one of DER NET PEM
<code>-in arg</code>	input file
<code>-out arg</code>	output file
<code>-des</code>	encrypt PEM output with cbc des
<code>-des3</code>	encrypt PEM output with ede cbc des using 168 bit key
<code>-text</code>	print the key in text
<code>-noout</code>	do not print key out
<code>-modulus</code>	print the RSA key modulus

### Using the `rsa` Utility

Converting a private key to PEM format from DER format involves using the `rsa` utility as follows:

```
openssl rsa -inform DER -in MyKey.der -outform PEM -out MyKey.pem
```

Changing the pass phrase which is used to encrypt the private key involves using the `rsa` utility as follows:

```
openssl rsa -inform PEM -in MyKey.pem -outform PEM -out MyKey.pem
-des3
```

Removing encryption from the private key (which is not recommended) involves using the `rsa` command utility as follows:

```
openssl rsa -inform PEM -in MyKey.pem -outform PEM -out MyKey2.pem
```

**Note:** Do not specify the same file for the `-in` and `-out` parameters, because this can corrupt the file.

---

## The ca Utility

---

### Purpose of the `ca` utility

You can use the `ca` utility create X.509 certificates by signing existing signing requests. It is imperative that you check the details of a certificate request before signing. Your organization should have a policy with respect to the issuing of certificates.

The `ca` utility is used to sign certificate requests thereby creating a valid X.509 certificate which can be returned to the request submitter. It can also be used to generate Certificate Revocation Lists (CRLs). For information on the `ca -policy` and `-name` options, refer to [“The OpenSSL Configuration File” on page 758](#).

---

### Creating a new CA

To create a new CA using the `openssl ca` utility, two files (`serial` and `index.txt`) need to be created in the location specified by the `openssl` configuration file that you are using.

---

### Options

The options supported by the `openssl ca` utility are as follows:

<code>-verbose</code>	- Talk alot while doing things
<code>-config file</code>	- A config file
<code>-name arg</code>	- The particular CA definition to use
<code>-genctrl</code>	- Generate a new CRL
<code>-crl days</code>	- Days is when the next CRL is due
<code>-crl hours</code>	- Hours is when the next CRL is due
<code>-days arg</code>	- number of days to certify the certificate for
<code>-md arg</code>	- md to use, one of md2, md5, sha or sha1
<code>-policy arg</code>	- The CA 'policy' to support
<code>-keyfile arg</code>	- PEM private key file
<code>-key arg</code>	- key to decode the private key if it is encrypted
<code>-cert</code>	- The CA certificate
<code>-in file</code>	- The input PEM encoded certificate request(s)
<code>-out file</code>	- Where to put the output file(s)
<code>-outdir dir</code>	- Where to put output certificates

```
-infile...      - The last argument, requests to process
-spkac file     - File contains DN and signed public key and
                challenge
-preserveDN     - Do not re-order the DN
-batch          - Do not ask questions
-msie_hack      - msie modifications to handle all thos
                universal strings
```

**Note:** Most of the above parameters have default values as defined in `openssl.cnf`.

---

### Using the ca Utility

Converting a private key to PEM format from DER format involves using the `ca` utility as shown in the following example. To sign the supplied CSR `MyReq.pem` to be valid for 365 days and create a new X.509 certificate in PEM format, use the `ca` utility as follows:

```
openssl ca -config ssl_conf_path_name -days 365
-in MyReq.pem -out MyNewCert.pem
```



---

## The s\_client Utility

---

### Purpose of the s\_client utility

You can use the `s_client` utility to debug an SSL/TLS server. Using the `s_client` utility, you can negotiate an SSL/TLS handshake under controlled conditions, accompanied by extensive logging and error reporting.

---

### Options

The options supported by the `openssl s_client` utility are as follows:

```
-connect          - Specify the host and (optionally) port to
host[:port]      connect to. Default is local host and port 4433.
-cert certname   - Specifies the certificate to use, if one is
                  requested by the server.
-certform format - The certificate format, which can be either
                  PEM or DER. Default is PEM.
-key keyfile     - File containing the client's private key.
                  Default is to extract the key from the client
                  certificate.
-keyform format  - The private key format, which can be either
                  PEM or DER. Default is PEM.
-pass arg        - The private key password.
-verify depth    - Maximum server certificate chain length.
-CApath directory - Directory to use for server certificate
                  verification.
-CAfile file     - File containing trusted CA certificates.
-reconnect       - Reconnects to the same server five times using
                  the same session ID.
-pause           - Pauses for one second between each read and
                  write call.
-showcerts      - Display the whole server certificate chain.
-prexit         - Print session information when the program
                  exits.
-state          - Prints out the SSL session states.
-debug          - Log debug data, including hex dump of
                  messages.
-msg            - Show all protocol messages with hex dump.
-nbio_test      - Tests non-blocking I/O.
```

- nbio - Turns on non-blocking I/O.
- crlf - Translates a line feed (LF) from the terminal into CR+LF, as required by some servers.
- ign\_eof - Inhibits shutting down the connection when end of file is reached in the input.
- quiet - Inhibits printing of session and certificate information; implicitly turns on -ign\_eof as well.
- ssl2, -ssl3, -tls1, -no\_ssl2, -no\_ssl3, -no\_tls1 - These options enable/disable the use of certain SSL or TLS protocols.
- bugs - Enables workarounds to several known bugs in SSL and TLS implementations.
- cipher cipherlist - Specifies the cipher list sent by the client. The server should use the first supported cipher from the list sent by the client.
- starttls protocol - Send the protocol-specific message(s) to switch to TLS for communication, where the protocol can be either smtp or pop3.
- engine id - Specifies an engine, by it's unique id string.
- rand file(s) - A file or files containing random data used to seed the random number generator, or an EGD socket. The file separator is ; for MS-Windows, , for OpenVMS, and : for all other platforms.

### Using the `s_client` utility

Before running the `s_client` utility, there must be an active SSL/TLS server for you to connect to. For example, you could have an `s_server` test server running on the local host, listening on port 9000. To run the `s_client` test client, open a command prompt and enter the following command:

```
openssl s_client -connect localhost:9000 -ssl3
-cert clientcert.pem
```

Where `clientcert.pem` is a file containing the client's X.509 certificate in PEM format. When you enter the command, you are prompted to enter the pass phrase for the `clientcert.pem` file.

---

## The s\_server Utility

---

### Purpose of the s\_server utility

You can use the `s_server` utility to debug an SSL/TLS client. By entering `openssl s_server` at the command line, you can run a simple SSL/TLS server that listens for incoming SSL/TLS connections on a specified port. The server can be configured to provide extensive logging and error reporting.

---

### Options

The options supported by the `openssl s_server` utility are as follows:

- accept port           - Specifies the IP port to listen for incoming connections. Default is port 4433.
- context id           - Sets the SSL context id (any string value).
- cert certname       - Specifies the certificate to use for the server.
- certform format     - The certificate format, which can be either PEM or DER. Default is PEM.
- key keyfile          - File containing the server's private key. Default is to extract the key from the server certificate.
- keyform format      - The private key format, which can be either PEM or DER. Default is PEM.
- pass arg            - The private key password.
- dcert filename,     - Specifies an additional certificate and  
-dkey keyname        private key, enabling the server to have multiple credentials.
- dcertform format, - Specifies additional certificate format,  
-dkeyform format, private key format, and passphrase respectively.  
-dpass arg
- nocert              - If this option is set, no certificate is used.
- dhparam filename   - The DH parameter file to use.
- no\_dhe              - If this option is set, no DH parameters will be loaded, effectively disabling the ephemeral DH cipher suites.
- no\_tmp\_rsa          - Certain export cipher suites sometimes use a temporary RSA key. This option disables temporary RSA key generation.

- verify depth, -Verify depth - Maximum client certificate chain length. With the -Verify option, the client must supply a certificate or an error occurs.
- CApath directory - Directory to use for client certificate verification.
- CAfile file - File containing trusted CA certificates.
- state - Prints out the SSL session states.
- debug - Log debug data, including hex dump of messages.
- msg - Show all protocol messages with hex dump.
- nbio\_test - Tests non-blocking I/O.
- nbio - Turns on non-blocking I/O.
- crlf - Translates a line feed (LF) from the terminal into CR+LF, as required by some servers.
- quiet - Inhibits printing of session and certificate information; implicitly turns on -ign\_eof as well.
- ssl2, -ssl3, -tls1, -no\_ssl2, -no\_ssl3, -no\_tls1 - These options enable/disable the use of certain SSL or TLS protocols.
- bugs - Enables workarounds to several known bugs in SSL and TLS implementations.
- hack - Enables a further workaround for some some early Netscape SSL code.
- cipher cipherlist - Specifies the cipher list sent by the client. The server should use the first supported cipher from the list sent by the client.
- www - Sends a status message back to the client when it connects. The status message is in HTML format.
- WWW - Emulates a simple web server, where pages are resolved relative to the current directory.
- HTTP - Emulates a simple web server, where pages are resolved relative to the current directory.
- engine id - Specifies an engine, by it's unique id string.
- id\_prefix\_arg - Generate SSL/TLS session IDs prefixed by arg.

`-rand file(s)` - A file or files containing random data used to seed the random number generator, or an EGD socket. The file separator is `;` for MS-Windows, `,` for OpenVMS, and `:` for all other platforms.

---

### Connected commands

When an SSL client is connected to the test server, you can enter any of the following single letter commands at the server side:

`q` End the current SSL connection but still accept new connections.  
`Q` End the current SSL connection and exit.  
`r` Renegotiate the SSL session.  
`R` Renegotiate the SSL session and request a client certificate.  
`P` Send some plain text down the underlying TCP connection. This should cause the client to disconnect due to a protocol violation.  
`S` Print out some session cache status information.

---

### Using the `s_server` utility

To use the `s_server` utility to debug SSL clients, start the test server with the following command:

```
openssl s_server -accept 9000 -cert servercert.pem
```

Where the test server listens on the IP port 9000 and `servercert.pem` is a file containing the server's X.509 certificate in PEM format.

The `s_server` utility also provides a convenient way to test a secure Web browser. If you start the `s_server` utility with the `-www` switch, the test server functions as a simple Web server, serving up pages from the current directory. For example:

```
openssl s_server -accept 9000 -cert servercert.pem -www
```

---

# The OpenSSL Configuration File

---

## Overview

A number of OpenSSL commands (for example, `req` and `ca`) take a `-config` parameter that specifies the location of the openssl configuration file. This section provides a brief description of the format of the configuration file and how it applies to the `req` and `ca` commands. An example configuration file is listed at the end of this section.

---

## Structure of `openssl.cnf`

The `openssl.cnf` configuration file consists of a number of sections that specify a series of default values that are used by the openssl commands.

---

## In this section

This section contains the following subsections:

<a href="#">[req] Variables</a>	<a href="#">page 759</a>
<a href="#">[ca] Variables</a>	<a href="#">page 760</a>
<a href="#">[policy] Variables</a>	<a href="#">page 761</a>
<a href="#">Example openssl.cnf File</a>	<a href="#">page 762</a>

---

## [req] Variables

---

### Overview of the variables

The `req` section contains the following variables:

```
default_bits = 1024
default_keyfile = privkey.pem
distinguished_name = req_distinguished_name
attributes = req_attributes
```

---

### `default_bits` configuration variable

The `default_bits` variable is the default RSA key size that you wish to use. Other possible values are 512, 2048, and 4096.

---

### `default_keyfile` configuration variable

The `default_keyfile` variable is the default name for the private key file created by `req`.

---

### `distinguished_name` configuration variable

The `distinguished_name` variable specifies the section in the configuration file that defines the default values for components of the distinguished name field. The `req_attributes` variable specifies the section in the configuration file that defines defaults for certificate request attributes.

---

## [ca] Variables

---

### Choosing the CA section

You can configure the file `openssl.cnf` to support a number of CAs that have different policies for signing CSRs. The `-name` parameter to the `ca` command specifies which CA section to use. For example:

```
openssl ca -name MyCa ...
```

This command refers to the CA section `[MyCa]`. If `-name` is not supplied to the `ca` command, the CA section used is the one indicated by the `default_ca` variable. In the [“Example openssl.cnf File” on page 762](#), this is set to `CA_default` (which is the name of another section listing the defaults for a number of settings associated with the `ca` command). Multiple different CAs can be supported in the configuration file, but there can be only one default CA.

---

### Overview of the variables

Possible `[ca]` variables include the following

`dir`: The location for the CA database  
The database is a simple text database containing the following tab separated fields:

```
status:    A value of 'R' - revoked, 'E' -expired or 'V' valid
issued date: When the certificate was certified
revoked date: When it was revoked, blank if not revoked
serial number: The certificate serial number
certificate: Where the certificate is located
CN: The name of the certificate
```

The serial number field should be unique, as should the `CN/status` combination. The `ca` utility checks these at startup.

```
certs: This is where all the previously issued certificates are
kept
```



---

## [policy] Variables

---

### Choosing the policy section

The policy variable specifies the default policy section to be used if the `-policy` argument is not supplied to the `ca` command. The CA policy section of a configuration file identifies the requirements for the contents of a certificate request which must be met before it is signed by the CA.

There are two policy sections defined in the [“Example openssl.cnf File” on page 762](#): `policy_match` and `policy_anything`.

---

### Example policy section

The `policy_match` section of the example `openssl.cnf` file specifies the order of the attributes in the generated certificate as follows:

```
countryName
stateOrProvinceName
organizationName
organizationalUnitName
commonName
emailAddress
```

---

### The `match` policy value

Consider the following value:

```
countryName = match
```

This means that the country name must match the CA certificate.

---

### The `optional` policy value

Consider the following value:

```
organisationalUnitName = optional
```

This means that the `organisationalUnitName` does not have to be present.

---

### The `supplied` policy value

Consider the following value:

```
commonName = supplied
```

This means that the `commonName` must be supplied in the certificate request.

## Example openssl.cnf File

### Listing

The following listing shows the contents of an example `openssl.cnf` configuration file:

```
#####
# openssl example configuration file.
# This is mostly used for generation of certificate requests.
#####
[ ca ]
default_ca= CA_default          # The default ca section
#####

[ CA_default ]

dir=/opt/iona/OrbixSSL1.0c/certs # Where everything is kept

certs=$dir # Where the issued certs are kept
crl_dir= $dir/crl # Where the issued crl are kept
database= $dir/index.txt # database index file
new_certs_dir= $dir/new_certs # default place for new certs
certificate=$dir/CA/OrbixCA # The CA certificate
serial= $dir/serial # The current serial number
crl= $dir/crl.pem # The current CRL
private_key= $dir/CA/OrbixCA.pk # The private key
RANDFILE= $dir/.rand # private random number file
default_days= 365 # how long to certify for
default_crl_days= 30 # how long before next CRL
default_md= md5 # which message digest to use
preserve= no # keep passed DN ordering

# A few different ways of specifying how closely the request
# should conform to the details of the CA

policy= policy_match

# For the CA policy

[policy_match]
countryName= match
stateOrProvinceName= match
organizationName= match
organizationalUnitName= optional
commonName= supplied
```

```
emailAddress= optional

# For the 'anything' policy
# At this point in time, you must list all acceptable 'object'
# types

[ policy_anything ]
countryName = optional
stateOrProvinceName= optional
localityName= optional
organizationName = optional
organizationalUnitName = optional
commonName= supplied
emailAddress= optional

[ req ]
default_bits = 1024
default_keyfile= privkey.pem
distinguished_name = req_distinguished_name
attributes = req_attributes

[ req_distinguished_name ]
countryName= Country Name (2 letter code)
countryName_min= 2
countryName_max = 2
stateOrProvinceName= State or Province Name (full name)
localityName = Locality Name (eg, city)
organizationName = Organization Name (eg, company)
organizationalUnitName = Organizational Unit Name (eg, section)
commonName = Common Name (eg. YOUR name)
commonName_max = 64
emailAddress = Email Address
emailAddress_max = 40

[ req_attributes ]
challengePassword = A challenge password
challengePassword_min = 4
challengePassword_max = 20
unstructuredName= An optional company name
```



# Configuring the Java Runtime CORBA Binding

*The Java runtime version of the CORBA binding can be configured to load an Orbix configuration file, enabling you to set advanced configuration options. This appendix describes how to bootstrap the configuration mechanism, in order to associate an Orbix configuration file with the CORBA binding.*

---

**In this appendix**

This appendix discusses the following topics:

<a href="#">Java Runtime CORBA Binding Architecture</a>	<a href="#">page 766</a>
<a href="#">Bootstrapping the Configuration</a>	<a href="#">page 768</a>

# Java Runtime CORBA Binding Architecture

## Overview

Figure 59 gives an overview of the Java runtime CORBA binding architecture, showing the XML configuration file, `cx.xml` and the Orbix configuration file. This section describes how those configuration files fit into the architecture of the CORBA binding.

**Figure 59:** *Java Runtime CORBA Binding Architecture*

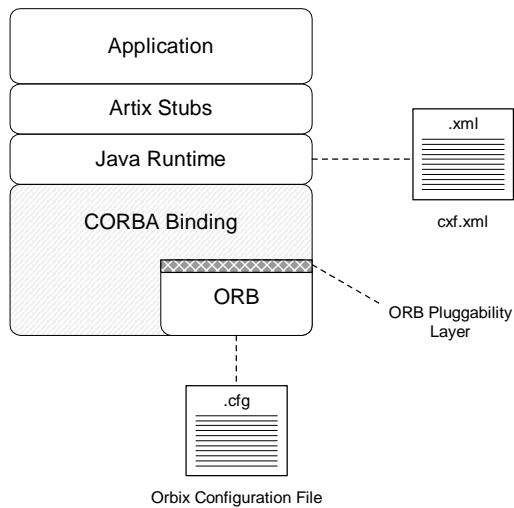

## CORBA binding

The CORBA binding is responsible for converting Artix operation invocations into the GIOP message format, enabling you to integrate your program with CORBA applications. The Java runtime version of the CORBA binding is designed with a pluggable ORB component.

---

**ORB pluggability layer**

In order to load an ORB implementation, the CORBA binding is equipped with an *ORB pluggability layer*. Artix configures this layer to load the Orbix ORB, which is the only option that is currently supported.

**Note:** In principle, the ORB pluggability layer could allow a different ORB implementation to be integrated with the CORBA binding. In practice, however, the ORB pluggability layer is intended for internal Artix use only. Attempting to integrate another ORB with the CORBA binding is not supported by Artix.

---

**cx.xml file**

If you need to customize the ORB pluggability layer, you can add the appropriate configurations settings to the XML configuration file, `cx.xml`. In some cases, it makes sense to customize the ORB pluggability layer, because it allows you to pass initial arguments to the ORB instance that is instantiated inside the CORBA binding.

For example, the most common reason for customizing the ORB pluggability layer is to specify the location of a custom Orbix configuration file.

---

**Orbix configuration file**

You can optionally associate an Orbix configuration file with the CORBA binding. This provides you with access to the full power of Orbix configuration, which you can use to customize the Orbix runtime.

---

**Default configuration of the CORBA binding**

The CORBA binding is packaged with a default XML configuration file, which loads the Orbix ORB, and a default Orbix configuration file, which loads a minimal set of plug-ins. For simple applications, this is often sufficient.

For more advanced applications, however, you can customize the CORBA binding configuration as described in [“Bootstrapping the Configuration” on page 768](#).

---

# Bootstrapping the Configuration

## Overview

This section describes how to configure the ORB pluggability layer in the Java runtime CORBA binding, in order to read an Orbix style configuration file.

## Configuring the classpath

The configuration files for the Java runtime CORBA binding must be placed in a directory that is on the Java CLASSPATH. For example, if the CORBA binding's configuration files are placed in the directory, *ConfigDirectory*, you would need to configure the CLASSPATH as follows:

### Windows

```
set CLASSPATH=ConfigDirectory;%CLASSPATH%
```

### UNIX

```
export CLASSPATH=ConfigDirectory:$CLASSPATH
```

## Contents of the configuration directory

The CORBA binding's configuration directory typically contains the files shown in [Example 145](#).

### Example 145: CORBA Binding Configuration Directory Structure

```
ConfigDirectory/
|
|---- cxf.xml
|
|---- DomainName.cfg
```

By default, the Artix Java runtime searches for an XML configuration file named *cxf.xml* on the current CLASSPATH. If you want to give the XML configuration file a different name or if you want to locate it in a different directory with respect to the CLASSPATH, specify the file location using the *cxf.config.file* Java system property.

For example, you could specify the location of the XML configuration file as a command-line option to the Java interpreter, as follows:

```
-Dcxf.config.file=XMLConfigFile.xml.
```



**cx.xml file**

You can customize the ORB pluggability layer by adding appropriate bean settings to the XML configuration file, `cx.xml`. [Example 146](#) shows you how to configure the ORB pluggability by adding beans with ID equal to `artixORBProperties` and `artixCorbaBindingFactory` respectively.

**Example 146: XML Configuration for Custom CORBA Binding**

```
<?xml version="1.0" encoding="UTF-8"?>
<beans xmlns="http://www.springframework.org/schema/beans"
       xmlns:xsi="http://www.w3.org/2001/XMLSchema-instance"
       xmlns:http="http://cxf.apache.org/transport/http/configuration"
       xsi:schemaLocation="..." >
  ...
  <bean id="artixORBProperties" class="com.ionacxf.bindings.corba.ORBProperties">
    <property name="orbArgs">
      <list>
        <value>-ORBdomain_name</value>
        <value>default_servants-domain</value>
        <value>-ORBname</value>
        <value>tests.default_servants.server</value>
      </list>
    </property>
    <property name="factory" ref="artixCorbaBindingFactory"/>
  </bean>
  <bean id="artixCorbaBindingFactory"
        class="com.ionacxf.bindings.corba.CorbaBindingFactory" lazy-init="true">
    <property name="bus" ref="cxf"/>
    <property name="activationNamespaces">
      <set>
        <value>http://schemas.apache.org/yoko/bindings/corba</value>
      </set>
    </property>
    <property name="transportIds">
      <list>
        <value>http://schemas.apache.org/yoko/bindings/corba</value>
      </list>
    </property>
    <property name="orbClass">
      <value>com.ionacorba.art.artimpl.ORBImpl</value>
    </property>
    <property name="orbSingletonClass">
      <value>com.ionacorba.art.artimpl.ORBSingleton</value>
    </property>
  </bean>
</beans>
```

---

## Specifying ORB arguments

Normally, the only part of the XML configuration you need to edit is the `orbArgs` property, which enables you to pass command-line arguments to the underlying ORB runtime.

The following ORB arguments can be used to bootstrap the Orbix configuration file:

- `-ORBdomain-name DomainName`—specifies the name of the Orbix configuration file, without the `.cfg` suffix.  
For example, the ORB domain name setting in [Example 146 on page 769](#) would direct the CORBA binding to search for the configuration file, `hello_world.cfg`, in the configuration directory (where the configuration directory is listed in the CLASSPATH). If necessary, Artix will search for the configuration file by looking in each of the directories in the CLASSPATH.
- `-ORBname ConfigScopeName`—specifies the name of the ORB instance. This name is also used to identify the *configuration scope* in the Orbix configuration file, from which the ORB takes its configuration data. The period character, `.`, is used as a separator to specify a nested configuration scope name. See [Example 146 on page 769](#).
- `-ORBconfig_domains_dir ConfigFileDir`—specifies the directory containing the Orbix configuration file, relative to the configuration directory.

---

## DomainName.cfg file

The Orbix configuration file, `DomainName.cfg`, has the same syntax as a regular Orbix configuration file or Artix C++ runtime configuration file. In this file, you can set any CORBA-related configuration variables—see the CORBA chapter in the *Artix Configuration Reference*.

For example, given the bootstrap settings shown in [Example 146 on page 769](#), you would store the CORBA configuration settings in a file called `hello_world.cfg`. The settings relevant to your program would then be taken from the `samples.HelloWorld` configuration scope, as follows:

```
# Orbix Configuration File
...
samples {
  HelloWorld {
    ... # Settings for 'samples.HelloWorld' ORB name
  };
};
```



# License Issues

*This appendix contains the text of licenses relevant to Artix.*

---

## **In this appendix**

This appendix contains the following section:

<a href="#">OpenSSL License</a>	<a href="#">page 774</a>
---------------------------------	--------------------------

---

# OpenSSL License

---

## Overview

The licence agreement for the usage of the OpenSSL command line utility shipped with Artix SSL/TLS is as follows:

### LICENSE ISSUES

```
=====
The OpenSSL toolkit stays under a dual license, i.e. both the conditions of
the OpenSSL License and the original SSLeay license apply to the toolkit.
See below for the actual license texts. Actually both licenses are BSD-style
Open Source licenses. In case of any license issues related to OpenSSL
please contact openssl-core@openssl.org.
```

OpenSSL License

```
-----
/* =====
* Copyright (c) 1998-1999 The OpenSSL Project. All rights reserved.
*
* Redistribution and use in source and binary forms, with or without
* modification, are permitted provided that the following conditions
* are met:
*
* 1. Redistributions of source code must retain the above copyright
* notice, this list of conditions and the following disclaimer.
*
* 2. Redistributions in binary form must reproduce the above copyright
* notice, this list of conditions and the following disclaimer in
* the documentation and/or other materials provided with the
* distribution.
*
* 3. All advertising materials mentioning features or use of this
* software must display the following acknowledgment:
* "This product includes software developed by the OpenSSL Project
* for use in the OpenSSL Toolkit. (http://www.openssl.org/)"
*
* 4. The names "OpenSSL Toolkit" and "OpenSSL Project" must not be used to
* endorse or promote products derived from this software without
* prior written permission. For written permission, please contact
* openssl-core@openssl.org.
*
* 5. Products derived from this software may not be called "OpenSSL"
* nor may "OpenSSL" appear in their names without prior written
* permission of the OpenSSL Project.
```

```

*
* 6. Redistributions of any form whatsoever must retain the following
* acknowledgment:
*   "This product includes software developed by the OpenSSL Project
*   for use in the OpenSSL Toolkit (http://www.openssl.org/)"
*
* THIS SOFTWARE IS PROVIDED BY THE OpenSSL PROJECT ``AS IS'' AND ANY
* EXPRESSED OR IMPLIED WARRANTIES, INCLUDING, BUT NOT LIMITED TO, THE
* IMPLIED WARRANTIES OF MERCHANTABILITY AND FITNESS FOR A PARTICULAR
* PURPOSE ARE DISCLAIMED.  IN NO EVENT SHALL THE OpenSSL PROJECT OR
* ITS CONTRIBUTORS BE LIABLE FOR ANY DIRECT, INDIRECT, INCIDENTAL,
* SPECIAL, EXEMPLARY, OR CONSEQUENTIAL DAMAGES (INCLUDING, BUT
* NOT LIMITED TO, PROCUREMENT OF SUBSTITUTE GOODS OR SERVICES;
* LOSS OF USE, DATA, OR PROFITS; OR BUSINESS INTERRUPTION)
* HOWEVER CAUSED AND ON ANY THEORY OF LIABILITY, WHETHER IN CONTRACT,
* STRICT LIABILITY, OR TORT (INCLUDING NEGLIGENCE OR OTHERWISE)
* ARISING IN ANY WAY OUT OF THE USE OF THIS SOFTWARE, EVEN IF ADVISED
* OF THE POSSIBILITY OF SUCH DAMAGE.
* =====
*
* This product includes cryptographic software written by Eric Young
* (eay@cryptsoft.com).  This product includes software written by Tim
* Hudson (tjh@cryptsoft.com).
*
*/

```

Original SSLeay License

-----

```

/* Copyright (C) 1995-1998 Eric Young (eay@cryptsoft.com)
* All rights reserved.
*
* This package is an SSL implementation written
* by Eric Young (eay@cryptsoft.com).
* The implementation was written so as to conform with Netscapes SSL.
*
* This library is free for commercial and non-commercial use as long as
* the following conditions are aheared to.  The following conditions
* apply to all code found in this distribution, be it the RC4, RSA,
* lhash, DES, etc., code; not just the SSL code.  The SSL documentation
* included with this distribution is covered by the same copyright terms
* except that the holder is Tim Hudson (tjh@cryptsoft.com).
*
* Copyright remains Eric Young's, and as such any Copyright notices in
* the code are not to be removed.
* If this package is used in a product, Eric Young should be given attribution
* as the author of the parts of the library used.

```

```

* This can be in the form of a textual message at program startup or
* in documentation (online or textual) provided with the package.
*
* Redistribution and use in source and binary forms, with or without
* modification, are permitted provided that the following conditions
* are met:
* 1. Redistributions of source code must retain the copyright
*   notice, this list of conditions and the following disclaimer.
* 2. Redistributions in binary form must reproduce the above copyright
*   notice, this list of conditions and the following disclaimer in the
*   documentation and/or other materials provided with the distribution.
* 3. All advertising materials mentioning features or use of this software
*   must display the following acknowledgement:
*   "This product includes cryptographic software written by
*     Eric Young (eay@cryptsoft.com) "
*   The word 'cryptographic' can be left out if the routines from the library
*   being used are not cryptographic related :-).
* 4. If you include any Windows specific code (or a derivative thereof) from
*   the apps directory (application code) you must include an acknowledgement:
*   "This product includes software written by Tim Hudson (tjh@cryptsoft.com) "
*
* THIS SOFTWARE IS PROVIDED BY ERIC YOUNG ``AS IS'' AND
* ANY EXPRESS OR IMPLIED WARRANTIES, INCLUDING, BUT NOT LIMITED TO, THE
* IMPLIED WARRANTIES OF MERCHANTABILITY AND FITNESS FOR A PARTICULAR PURPOSE
* ARE DISCLAIMED.  IN NO EVENT SHALL THE AUTHOR OR CONTRIBUTORS BE LIABLE
* FOR ANY DIRECT, INDIRECT, INCIDENTAL, SPECIAL, EXEMPLARY, OR CONSEQUENTIAL
* DAMAGES (INCLUDING, BUT NOT LIMITED TO, PROCUREMENT OF SUBSTITUTE GOODS
* OR SERVICES; LOSS OF USE, DATA, OR PROFITS; OR BUSINESS INTERRUPTION)
* HOWEVER CAUSED AND ON ANY THEORY OF LIABILITY, WHETHER IN CONTRACT, STRICT
* LIABILITY, OR TORT (INCLUDING NEGLIGENCE OR OTHERWISE) ARISING IN ANY WAY
* OUT OF THE USE OF THIS SOFTWARE, EVEN IF ADVISED OF THE POSSIBILITY OF
* SUCH DAMAGE.
*
* The licence and distribution terms for any publically available version or
* derivative of this code cannot be changed.  i.e. this code cannot simply be
* copied and put under another distribution licence
* [including the GNU Public Licence.]
*/

```



# Index

## Symbols

.NET

- and principal propagation 493
- `<action-role-mapping>` tag 355
- `<interface>` tag 355
- `<name>` tag 356
- `<realm>` tag 345
- `<role>` tag 345
- `<server-name>` tag 355
- `<users>` tag 345

## A

access control

- `wsd12acl` subcommand 357

ACL

- `<action-role-mapping>` tag 355
- `<interface>` tag 355
- `<name>` tag 356
- `<server-name>` tag 355
- `action_role_mapping` configuration variable 361
- action-role mapping file 353
- action-role mapping file, example 354
- action-role mapping
  - and role-based access control 339
- `action_role_mapping` configuration variable 152, 361

action-role mapping file

- `<action-role-mapping>` tag 355
- `<interface>` tag 355
- `<name>` tag 356
- `<server-name>` tag 355

CORBA

- configuring 353
- example 354
- administration
  - OpenSSL command-line utilities 181
- and iSF adapter properties 599

Artix security layer

- and certificate-based authentication 118, 123

Artix security plug-in

- and security layer 87
- `authentication_cache_size` configuration variable 90

artix\_security plug-in

- loading and basic configuration 380
- Artix security plug-in plug-in
  - `authentication_cache_timeout` configuration variable 90
- Artix security service
  - and embedded deployment 585
  - architecture 581
  - configuring 271
  - definition 582
  - features 582
  - file adapter 293
  - `is2.properties` file 293
  - LDAP adapter 295
  - LDAP adapter, properties 296
  - log4j logging 333
  - `plugins:java_server:classpath` configuration variable 600
  - security information file 293
  - standalone deployment of 584
- ASN.1 173, 731
  - attribute types 734
  - AVA 734
  - OID 733
  - RDN 735
- ASP plug-in
  - caching of credentials 89
- asp plug-in
  - `default_password` configuration value 488
  - `security_type` configuration variable 488
- association options
  - and cipher suite constraints 264
  - and mechanism policy 253
  - client secure invocation policy, default 250
  - compatibility with cipher suites 265
  - `EstablishTrustInClient` 107, 108, 145, 159
  - `NoProtection` 147
  - rules of thumb 253
  - SSL/TLS
    - Confidentiality 247
    - DetectMisordering 247
    - DetectReplay 247
    - `EstablishTrustInClient` 248

- EstablishTrustInTarget 248
- Integrity 247
- NoProtection 247
- setting 244
- target secure invocation policy, default 252
- attribute value assertion 734
- authenticate() method
  - in IS2Adapter 593
- authentication
  - and security layer 87
  - caching of credentials 89
  - certificate-based 84
  - CSI 84
  - HTTP Basic Authentication 84
  - iSF
    - process of 149
  - own certificate, specifying 216
  - SSL/TLS
    - mutual 201
    - target only 197
    - trusted CA list 206
- authentication\_cache\_size configuration
  - variable 89, 90
- authentication\_cache\_timeout configuration
  - variable 89, 90
- authorization
  - and security layer 87
  - caching of credentials 89
  - role-based access control 339
  - roles
    - creating 342
    - special 343
- authorization realm
  - adding a server 341
  - IONAGlobalRealm realm 343
  - iSF 339
  - iSF, setting in server 152
  - roles in 341
  - servers in 340
  - special 343
- authorization realms
  - creating 342
- AVA 734

**B**

- backward trust 159
- Baltimore toolkit
  - selecting for C++ applications 611
- Basic Encoding Rules 732

- BER 732
- bus:initial\_contract:url:login\_service configuration
  - variable 404, 405, 409, 416
- bus:security 383
- BUSname argument 357
- bus-security:security interceptor 117, 410

**C**

- CA 172
  - choosing a host 176
  - commercial CAs 175
  - index file 183
  - list of trusted 178
  - multiple CAs 178
  - private CAs 176
  - private key, creating 184
  - security precautions 176
  - See *Alsocertificate authority*
  - self-signed 184
  - serial file 183
  - trusted list 206
- 760
- CA, setting up 182
- CACHE\_CLIENT session caching value 267
- CACHE\_NONE session caching value 267
- CACHE\_SERVER\_AND\_CLIENT session caching
  - value 267
- CACHE\_SERVER session caching value 267
- caching
  - authentication\_cache\_size configuration
    - variable 89, 90
  - authentication\_cache\_timeout configuration
    - variable 89, 90
  - CACHE\_CLIENT session caching value 267
  - CACHE\_NONE session caching value 267
  - CACHE\_SERVER\_AND\_CLIENT session caching
    - value 267
  - CACHE\_SERVER session caching value 267
  - of credentials 89
  - SSL/TLS
    - cache size 267
    - validity period 267
- Caching sessions 267
- CAs 182
- ca utility 751
- CertConstraintsPolicy 605
- CertConstraintsPolicy policy 605
- certificate authority
  - and certificate signing 172

- certificate-based authentication 84
  - and HTTP 94
  - example scenario 118, 123, 135, 161
  - file adapter, configuring 346
  - LDAP adapter, configuring 349
- certificate constraints policy
  - three-tier target server 159
- certificate\_constraints\_policy variable 230, 605
- Certificates
  - chain length 229
  - constraints 230, 605
- certificates
  - CertConstraintsPolicy policy 605
  - chaining 177
  - constraint language 230, 605
  - constraints policy 159
  - contents of 173
  - creating and signing 185
  - importing and exporting 180
  - length limit 178
  - own, specifying 216
  - peer 177
  - PKCS#12 file 179
  - public key 173
  - public key encryption 258
  - security handshake 197, 202
  - self-signed 177, 184
  - serial number 173
  - signing 172, 186, 189
  - signing request 185, 189
  - trusted CA list 206
  - X.509 172
- certificate signing request 185, 189
  - common name 186
  - signing 186, 189
- chaining of certificates 177
- ciper suites
  - order of 262
- cipher suites
  - ciphersuites configuration variable 262
  - compatibility algorithm 265
  - compatibility with association options 265
  - default list 263
  - definitions 259
  - effective 264
  - encryption algorithm 258
  - exportable 259
  - integrity-only ciphers 258
  - key exchange algorithm 258
  - mechanism policy 261
  - secure hash algorithm 258
  - secure hash algorithms 259
  - security algorithms 258
  - specifying 257
  - standard ciphers 258
- ciphersuites configuration variable 262
- CLASSPATH 600
- client\_binding\_list configuration variable
  - iSF, client configuration 150
  - secure client 144
- ClientCertificate attribute 109
- ClientPrivateKeyPassword attribute 109
- client secure invocation policy 264
  - HTTPS 249
  - IIOPTLS 249
- ClientSecureInvocationPolicy policy 245
- client\_version\_policy
  - IIOPTLS 669
- close() method 593
- cluster.properties file
  - example 322
- clustering
  - definition 313
  - is2.cluster.properties.filename property 321
  - is2.replica.selector.classname 321
  - IT\_SecurityService initial reference 324
  - load balancing 327
  - login service 320, 321
  - plugins:security:iioptls:addr\_list variable 324
  - plugins:security:iioptls:host variable 325
  - plugins:security:iioptls:port variable 325
  - policies:iioptls:load\_balancing\_mechanism variable 328
  - securityInstanceURL property 322
- cluster properties file 318
- colocated invocations
  - and secure associations 242
- colocation
  - incompatibility with principal propagation 486
- com.iona.isp.adapters property 598
- common names
  - uniqueness 186
- Confidentiality association option 247
  - hints 255
- Confidentiality option 247
- configuration
  - and iSF standalone deployment 584
  - of the iSF adapter 598

- plugins:java\_server:classpath configuration variable 600
- Configuration file 758
- connection\_attempts 669
- constraint\_language 230, 605
- Constraints
  - for certificates 230, 605
- CORBA
  - action-role mapping file 353
  - action-role mapping file, example 354
  - and iSF client SDK 582
  - configuring principal propagation 487
  - intermediate server configuration 155
  - iSF, three-tier system 154
  - principal propagation 486
  - security, overview 140
  - SSL/TLS
    - client configuration 142
    - securing communications 142
  - three-tier target server configuration 157
- CORBA binding
  - CSI authorization over transport 84
  - CSI identity assertion 84
  - protocol layers 86
- CORBA Principal 83, 133
- CORBA security
  - CSlv2 plug-in 141
  - GSP plug-in 141
  - IIOP/TLS plug-in 141
- CSI
  - authorization over transport 84
  - identity assertion 84
- CSI interceptor 150
- CSlv2
  - certificate constraints policy 159
  - principal sponsor
    - client configuration 151
- CSlv2 plug-in
  - CORBA security 141
- CSR 185, 189

**D**

- data encryption standard
  - see DES
- default\_password configuration value 488
- DER 732
- DES
  - symmetric encryption 259
- DetectMisordering association option 247

- hints 255
- DetectMisordering option 247
- DetectReplay association option 247
  - hints 255
- DetectReplay option 247
- Distinguished Encoding Rules 732
- distinguished names
  - definition 733
- DN
  - definition 733
  - string representation 733
- domain name
  - ignored by iSF 149
- domains
  - federating across 314

**E**

- effective cipher suites
  - definition 264
- embedded deployment 585
  - loading an adapter class 600
- enable\_principal\_service\_context configuration variable 487
- encryption algorithm
  - RC4 259
- encryption algorithms 258
  - DES 259
  - symmetric 259
  - triple DES 259
- enterprise security service
  - and iSF security domains 337
- EstablishTrustInClient association option 107, 108, 145, 248
  - hints 254
  - three-tier target server 159
- EstablishTrustInClient option 248
- EstablishTrustInTarget association option 248
  - hints 254
- EstablishTrustInTarget option 248
- event\_log:filters 666
- exportable cipher suites 259

**F**

- failover
  - definition 319
- features, of the Artix security service 582
- federation
  - and the security service 314

- cluster properties file 318
- definition 313
- is2.cluster.properties.filename property 317
- is2.current.server.id property 314
- is2.properties file 317, 321
- plugins:security:iiop\_tls settings 318
- file adapter 293
  - configuring certificate-based authentication 346
  - properties 294
- file domain
  - <realm> tag 345
  - <users> tag 345
  - example 344
  - file location 344
  - managing 344

**G**

- generic server 584
- getAllUsers() method 595
- getAuthorizationInfo() method 594
- GroupBaseDN property 297
- GroupNameAttr property 297
- GroupObjectClass property 297
- GroupSearchScope property 298
- GSP plug-in
  - and security layer 87
  - authentication\_cache\_size configuration variable 89
  - authentication\_cache\_timeout configuration variable 89
  - caching of credentials 89
  - CORBA security 141
- GSSUP credentials 316

**H**

- high availability 319
- HTTP
  - security layer 93
  - security layers 92
- HTTP Basic Authentication 84, 94
  - overview 114
- HTTP-compatible binding
  - compatible bindings 93
  - overview 92
  - protocol layers 85
- HTTPS
  - ciphersuites configuration variable 262
  - client configuration 105, 107

- mutual authentication 109
- HTTPS security
  - overview 95, 103

**I**

- identity assertion 84
- IIOP/TLS
  - ciphersuites configuration variable 262
- IIOP/TLS plug-in
  - CORBA security 141
- IIOP plug-in
  - and semi-secure clients 143
- IIOP policies 664, 667
  - client version 669
  - connection attempts 669
  - export hostnames 674
  - export IP addresses 674
  - GIOP version in profiles 674
  - server hostname 673
  - TCP options
    - delay connections 675
    - receive buffer size 676
- IIOP policy
  - ports 673
- IIOP\_TLS interceptor 144
- index file 183
- initialize() method 593, 599
- Integrity association option 247
  - hints 255
- integrity-only ciphers 258
- Integrity option 247
- interceptors
  - artix security 117
  - bus-security 410
  - login\_client 409
- interoperability
  - explicit principal header 494
  - with .NET 493
  - with Orbix applications 486
- invocation policies
  - interaction with mechanism policy 253
- IONAGlobalRealm 595
- IONAGlobalRealm realm 343
- IONAUserRole 357
- is2.cluster.properties.filename property
  - and clustering 321
  - and federation 317
- is2.current.server.id property 314
  - and clustering 321

- is2.properties file 293
    - and clustering 321
    - and federation 317, 321
    - and iSF adapter configuration 586
  - IS2AdapterException class 594
  - IS2Adapter Java interface 586
    - implementing 587
  - iS2 adapters
    - file domain
      - managing 344
    - LDAP domain
      - managing 349
    - standard adapters 582
  - iSF
    - action\_role\_mapping configuration variable 152
    - and certificate-based authentication 161
    - authorization realm
      - setting in server 152
    - client configuration
      - CSI interceptor 150
    - CORBA
      - three-tier system 154
      - three-tier target server configuration 157
      - two-tier scenario description 149
    - CORBA security 140
    - domain name, ignoring 149
    - intermediate server configuration 155
    - security domain
      - creating 338
    - server configuration
      - server\_binding\_list 150
    - server\_domain\_name configuration variable 152
    - three-tier scenario description 155
    - user account
      - creating 338
  - iSF adapter
    - adapter class property 598
    - and IONAGlobalRealm 595
    - and the iSF architecture 582
    - authenticate() method 593
    - close() method 593
    - com.iona.isp.adapters property 598
    - configuring to load 598
    - custom adapter, main elements 586
    - example code 587
    - getAllUsers() method 595
    - getAuthorizationInfo() method 594
    - initialize() method 593, 599
    - logout() method 596
    - overview 586
    - property format 599
    - property truncation 599
    - WRONG\_NAME\_PASSWORD minor
      - exception 594
  - iSF adapters
    - enterprise security service 337
  - iSF adapter SDK
    - and the iSF architecture 582
  - iSF client
    - in iSF architecture 581
  - iSF client SDK 582
  - iSF server
    - plugins:java\_server:classpath configuration
      - variable 600
  - IT\_SecurityService initial reference 324
- ## J
- J2EE
    - and iSF client SDK 582
  - JCE architecture
    - enabling 621
- ## K
- Kerberos 301
    - token 83
  - key exchange algorithms 258
- ## L
- LDAP adapter 295
    - basic properties 298
    - configuring certificate-based authentication 349
    - GroupBaseDN property 297
    - GroupNameAttr property 297
    - GroupObjectClass property 297, 298
    - LDAP server replicas 299
    - MemberDNAttr property 298
    - PrincipalUserDN property 300
    - PrincipalUserPassword property 300
    - properties 296
    - replica index 299
    - RoleNameAttr property 297
    - SSLCACertDir property 300
    - SSLClientCertFile property 300
    - SSLClientCertPassword property 300
    - SSLEnabled property 300
    - UserBaseDN property 297
    - UserNameAttr property 297

- UserObjectClass property 297
- UserRoleDNAttr property 297
- LDAP database
  - and clustering 320
- LDAP domain
  - managing 349
- Lightweight Directory Access Protocol
  - see LDAP
- load balancing 320
  - and clustering 327
  - policies:iiop\_tls:load\_balancing\_mechanism variable 328
- local\_hostname 673
- log4j 333
  - documentation 333
- logging
  - in secure client 106, 144
  - log4j 333
- login\_client:login\_client interceptor 409
- login\_client plug-in 409
  - and the login service 390
- login service
  - and single sign-on 390
  - standalone deployment 391
  - WSDL contract for 406, 416
- login\_service plug-in
  - configuring 404, 405, 416
- logout() method 596

**M**

- max\_chain\_length\_policy configuration variable 229
- MD5 247, 259
- mechanism policy
  - interaction with invocation policies 253
- MechanismPolicy 247
- mechanism policy 261
- MemberDNAttr property 298
- message digest 5
  - see MD5
- message digests 247
- message fragments 247
- mixed configurations, SSL/TLS 147
- multi-homed hosts, configure support for 673
- multiple CAs 178
- mutual authentication 201
  - HTTPS 109

**N**

- namespace
  - plugins:csi 622
  - plugins:gsp 623
  - policies 648
  - policies:csi 660
  - policies:https 664
  - policies:iiop\_tls 666
  - principal\_sponsor:csi 684
  - principle\_sponsor 680, 687, 689, 693
- no\_delay 675
- NoProtection association option
  - rules of thumb 253
- NoProtection association option 147, 247
  - hints 255
  - semi-secure applications 256
- NoProtection option 247

**O**

- opage Abstract Syntax Notation One
  - see ASN.1 731
- OpenSSL 176, 743
- openssl
  - configuration file 758
  - utilities 744
- openssl.cnf example file 762
- OpenSSL command-line utilities 181
- Orbit configuration file 584
- orb\_plugins configuration variable 143
  - client configuration 150
- orb\_plugins variable
  - and the NoProtection association option 255
  - semi-secure configuration 256

**P**

- Password attribute 115
- peer certificate 177
- performance
  - caching of credentials 89
- PKCS#12 files
  - creating 180, 185
  - definition 179
  - importing and exporting 180
  - viewing 180
- plug-ins
  - CSlv2, in CORBA security 141
  - GSP, in CORBA security 141

- IIOp 143
- IIOp/TLS, in CORBA security 141
- plugins:asp:default\_password configuration variable 136
- plugins:asp:security\_level 615
- plugins:asp:security\_level configuration variable 117
- plugins:csi:ClassName 622
- plugins:csi:shlib\_name 622
- plugins:gsp:authorization\_realm 624
- plugins:gsp:ClassName 625
- plugins:iioptcp\_listener:reincarnate\_attempts 632
- plugins:iioptcp\_listener:reincarnation\_retry\_backoff\_ratio 632
- plugins:iioptcp\_listener:reincarnation\_retry\_delay 632
- plugins:iioptls:hfs\_keyring\_file\_password 670
- plugins:iioptls:tcp\_listener:reincarnation\_retry\_backoff\_ratio 632
- plugins:iioptls:tcp\_listener:reincarnation\_retry\_delay 632
- plugins:java\_server:classpath configuration variable 600
- plugins:security:iioptls:addr\_list variable and clustering 324
- plugins:security:iioptls:host variable 325
- plugins:security:iioptls:port variable 325
- plugins:security:iioptls settings 318
- POA\_Coloc interceptor 486
- policies:max\_chain\_length\_policy 650
- policies
  - CertConstraintsPolicy 605
  - client secure invocation 264
  - ClientSecureInvocationPolicy 245
  - HTTPS
    - client secure invocation 249
    - target secure invocation 251
  - IIOp/TLS
    - client secure invocation 249
    - target secure invocation 251
  - target secure invocation 264
  - TargetSecureInvocationPolicy 245
- policies:allow\_unauthenticated\_clients\_policy 648
- policies:asp:enable\_authorization configuration variable 117
- policies:certificate\_constraints\_policy 649
- policies:csi:attribute\_service:client\_supports 660
- policies:csi:attribute\_service:target\_supports 661
- policies:csi:auth\_over\_transport:target\_supports 662
- policies:csi:auth\_over\_transport:client\_supports 661
- policies:csi:auth\_over\_transport:target\_requires 662
- policies:https:mechanism\_policy:ciphersuites 665
- policies:https:mechanism\_policy:protocol\_version 665
- policies:https:trace\_requests:enabled 666
- policies:https:trusted\_ca\_list\_policy 666
- policies:iioptls:allow\_unauthenticated\_clients\_policy 668
- policies:iioptls:certificate\_constraints\_policy 668
- policies:iioptls:client\_secure\_invocation\_policy:requires 669
- policies:iioptls:client\_secure\_invocation\_policy:supports 669
- policies:iioptls:client\_version\_policy 669
- policies:iioptls:connection\_attempts 669
- policies:iioptls:connection\_retry\_delay 670
- policies:iioptls:load\_balancing\_mechanism variable 328
- policies:iioptls:max\_chain\_length\_policy 670
- policies:iioptls:mechanism\_policy:ciphersuites 671
- policies:iioptls:mechanism\_policy:protocol\_version 672
- policies:iioptls:server\_address\_mode\_policy:local\_hostname 673
- policies:iioptls:server\_address\_mode\_policy:port\_range 673
- policies:iioptls:server\_address\_mode\_policy:publish\_hostname 674
- policies:iioptls:server\_version\_policy 674
- policies:iioptls:session\_caching\_policy 674
- policies:iioptls:target\_secure\_invocation\_policy:requires 675
- policies:iioptls:target\_secure\_invocation\_policy:supports 675
- policies:iioptls:tcp\_options:send\_buffer\_size 676
- policies:iioptls:tcp\_options\_policy:no\_delay 675
- policies:iioptls:tcp\_options\_policy:recv\_buffer\_size 676
- policies:iioptls:trusted\_ca\_list\_policy 676
- policies:mechanism\_policy:ciphersuites 651
- policies:mechanism\_policy:protocol\_version 652
- policies:session\_caching\_policy 652
- policies:target\_secure\_invocation\_policy:requires 653
- policies:target\_secure\_invocation\_policy:supports 653
- policies:trusted\_ca\_list\_policy 654



761  
 Principal 83  
 principals  
   and colocation 486  
   configuring propagation 487  
   explicit principal header 494  
   from O/S username 487  
   interoperability 486  
   interoperating with .NET 493  
   overview 486  
   reading on the server side 492  
   setting on the client side 490  
 principal sponsor  
   CSlv2  
     client configuration 151  
     SSL/TLS  
       enabling 111, 146  
       SSL/TLS, disabling 106, 108, 144  
 principal\_sponsor:csi:auth\_method\_data 685  
 principal\_sponsor:csi:use\_principal\_sponsor 684  
 principal\_sponsor Namespace Variables 680, 687, 689, 693  
 PrincipalUserDN property 300  
 PrincipalUserPassword property 300  
 principle\_sponsor:auth\_method\_data 681, 688, 690, 694  
 principle\_sponsor:auth\_method\_id 681, 688, 690, 694  
 principle\_sponsor:callback\_handler:ClassName 683  
 principle\_sponsor:login\_attempts 683  
 principle\_sponsor:use\_principle\_sponsor 680, 687, 689, 694  
 private key 184  
 protocol\_version configuration variable 261  
 public key encryption 258  
 public keys 173  
 publish\_hostname 674

## R

RC4 encryption 259  
 RDN 735  
 realm  
   see authorization realm  
 realms  
   IONAGlobalRealm, adding to 595  
 recv\_buffer\_size 676  
 relative distinguished name 735  
 Replay detection 247  
   759

REQUEST\_LEVEL security level 410  
 req utility 747  
 req Utility command 747  
 Rivest Shamir Adleman  
   see RSA  
 role-based access control 339  
   example 342  
 RoleNameAttr property 297  
 role-properties file 358  
 roles  
   creating 342  
   special 343  
 root certificate directory 178  
 RSA 258  
   symmetric encryption algorithm 259  
 RSA\_EXPORT\_WITH\_DES40\_CBC\_SHA cipher suite 258, 265  
 RSA\_EXPORT\_WITH\_RC4\_40\_MD5 cipher suite 258, 265  
 rsa utility 749  
 rsa Utility command 749  
 RSA\_WITH\_3DES\_EDE\_CBC\_SHA cipher suite 258, 265  
 RSA\_WITH\_DES\_CBC\_SHA cipher suite 258, 265  
 RSA\_WITH\_NULL\_MD5 cipher suite 258, 265  
 RSA\_WITH\_NULL\_SHA cipher suite 258, 265  
 RSA\_WITH\_RC4\_128\_MD5 cipher suite 258, 265  
 RSA\_WITH\_RC4\_128\_SHA cipher suite 258, 265

## S

Schannel toolkit  
   selecting for C++ applications 611  
 secure associations  
   client behavior 249  
   definition 242  
   TLS\_Coloc interceptor 242  
 secure hash algorithms 258, 259  
 security algorithms  
   and cipher suites 258  
 security domain  
   creating 338  
 security domains  
   architecture 337  
   ISF 338  
 security handshake  
   cipher suites 257  
   SSL/TLS 197, 202  
 security information file 293  
 securityInstanceURL property 322

- security layer
  - and HTTP 93
  - and SOAP binding 131
  - overview 87
- security levels
  - REQUEST\_LEVEL 410
- security service
  - federation of 314
- security\_type configuration variable 488
- self-signed CA 184
- self-signed certificate 177
- semi-secure applications
  - and NoProtection 256
- send\_principal configuration variable 487
- serial file 183
- serial number 173
- server\_binding\_list configuration variable 150
- ServerCertificate attribute 113
- server\_domain\_name configuration variable
  - iSF, ignored by 152
- ServerPrivateKeyPassword attribute 113
- server\_version\_policy
  - IIOp 674
- session\_cache\_size configuration variable 267
- session\_cache\_validity\_period configuration variable 267
- session\_caching\_policy configuraion variable 267
- session\_caching\_policy variable 267
- session idle timeout
  - SSO 391
- session timeout
  - SSO 391
- SHA 259
- SHA1 247
- signing certificates 172
- Single sign-on
  - and security layer 87
- single sign-on
  - SSO token 84
  - token timeouts 391
- SOAP
  - principal propagation 486
- SOAP 1.2
  - configuring Artix security plug-in for 380
- SOAP binding
  - configuring principal propagation 487
  - protocol layers 86, 130
  - security layer 131
  - SOAP protocol layer 131
- SSO overview 390
- Specifying ciphersuites 257
- SSL/TLS
  - association options
    - setting 244
  - caching validity period 267
  - cipher suites 257
  - client configuration 142
  - colocated invocations 242
  - encryption algorithm 258
  - IIOp\_TLS interceptor 144
  - key exchange algorithm 258
  - logging 106, 144
  - mechanism policy 261
  - mixed configurations 147
  - orb\_plugins list 143
  - principal sponsor
    - disabling 106, 108, 144
    - enabling 111, 146
  - protocol\_version configuration variable 261
  - secure associations 242
  - secure hash algorithm 258
  - secure hash algorithms 259
  - securing communications 142
  - security handshake 197, 202
  - selecting a toolkit, C++ 611
  - semi-secure client
    - IIOp plug-in 143
    - session cache size 267
    - TLS session 242
- SSLCACertDir property 300
- SSLClientCertFile property 300
- SSLClientCertPassword property 300
- SSLLeay 176
- SSLEnabled property 300
- SSO
  - advantages 390
  - login\_client plug-in 409
  - login service WSDL 406, 416
  - session idle timeout 391
  - session timeout 391
  - SOAP binding 390
  - username/password-based authentication 394, 408
- SSO token 84
  - and the login service 390
  - automatic refresh 391
  - timeouts 391
- standalone deployment 584

standard ciphers 258  
 symmetric encryption algorithms 259

## T

Target  
   choosing behavior 251  
 target authentication 197  
 target secure invocation policy 264  
   HTTPS 251  
   IIOP/TLS 251  
 TargetSecureInvocationPolicy policy 245  
 TCP policies  
   delay connections 675  
   receive buffer size 676  
 three-tier scenario description 155  
 TLS\_Coloc interceptor 242  
 TLS security  
   and HTTP 92  
 TLS session  
   definition 242  
 toolkit replaceability  
   enabling JCE architecture 621  
   selecting the toolkit, C++ 611  
 triple DES 259  
 truncation of property names 599  
 trusted CA list policy 206  
 trusted CAs 178  
 TrustedRootCertificates attribute 113

## U

use\_jsse\_tk configuration variable 621  
 user account  
   creating 338  
 UserBaseDN property 297  
 username/password-based authentication  
   overview 393, 407  
   SSO 394, 408  
 UserName attribute 115  
 UserNameAttr property 297

UserObjectClass property 297  
 UserRoleDNAttr property 297  
 UserSearchScope property  
   LDAP adapter  
     UserObjectClass property 297  
 UseSecureSockets attribute 112  
 utilities  
   wsdl2acl 357

## V

Variables 759, 760, 761

## W

Web service security extension  
   opage see WSSE 83  
 WRONG\_NAME\_PASSWORD minor exception 594  
 wsdl2acl subcommand 357  
 wsdltoacl utility  
   role-properties file 358  
 WSSE  
   Kerberos token 83  
   UsernameToken 83  
 WSSE Kerberos credentials 132  
 WSSE UsernameToken credentials 132  
 WSSEUsernameToken property 541, 543, 546,  
   549  
 WSSEX509Cert property 551, 554

## X

X.500 731  
 X.509  
   public key encryption 258  
 X.509 certificate  
   definition 172  
 X.509 certificates 171  
 x509 utility 745

