

# PROGRESS<sup>®</sup> ARTIX<sup>™</sup>

## Developing Advanced Artix Plug-Ins in C++ Version 5.6, December 2011

**© 2011 Progress Software Corporation and/or its subsidiaries or affiliates. All rights reserved.**

These materials and all Progress<sup>®</sup> software products are copyrighted and all rights are reserved by Progress Software Corporation. The information in these materials is subject to change without notice, and Progress Software Corporation assumes no responsibility for any errors that may appear therein. The references in these materials to specific platforms supported are subject to change.

Actional, Apama, Artix, Business Empowerment, DataDirect (and design), DataDirect Connect, DataDirect Connect64, DataDirect Technologies, DataDirect XML Converters, DataDirect XQuery, DataXtend, Dynamic Routing Architecture, EdgeXtend, Empowerment Center, Fathom, Fuse Mediation Router, Fuse Message Broker, Fuse Services Framework, IntelliStream, IONA, Making Software Work Together, Mindreef, ObjectStore, OpenEdge, Orbix, PeerDirect, POSSENET, Powered by Progress, PowerTier, Progress, Progress DataXtend, Progress Dynamics, Progress Business Empowerment, Progress Empowerment Center, Progress Empowerment Program, Progress OpenEdge, Progress Profiles, Progress Results, Progress Software Developers Network, Progress Sonic, ProVision, PS Select, Savvion, SequeLink, Shadow, SOAPscope, SOAPStation, Sonic, Sonic ESB, SonicMQ, Sonic Orchestration Server, SpeedScript, Stylus Studio, Technical Empowerment, Web-Speed, Xcalia (and design), and Your Software, Our Technology—Experience the Connection are registered trademarks of Progress Software Corporation or one of its affiliates or subsidiaries in the U.S. and/or other countries. AccelEvent, Apama Dashboard Studio, Apama Event Manager, Apama Event Modeler, Apama Event Store, Apama Risk Firewall, AppsAlive, AppServer, ASPen, ASP-in-a-Box, BusinessEdge, Business Making Progress, Cache-Forward, CloudEdge, DataDirect Spy, DataDirect SupportLink, Fuse, FuseSource, Future Proof, GVAC, High Performance Integration, ObjectStore Inspector, ObjectStore Performance Expert, OpenAccess, Orbacus, Pantero, POSSE, ProDataSet, Progress Arcade, Progress CloudEdge, Progress Control Tower, Progress ESP Event Manager, Progress ESP Event Modeler, Progress Event Engine, Progress RFID, Progress RPM, Progress Software Business Making Progress, PSE Pro, SectorAlliance, SeeThinkAct, Shadow z/Services, Shadow z/Direct, Shadow z/Events, Shadow z/Presentation, Shadow Studio, SmartBrowser, SmartComponent, SmartDataBrowser, SmartDataObjects, SmartDataView, SmartDialog, SmartFolder, SmartFrame, SmartObjects, SmartPanel, SmartQuery, SmartViewer, SmartWindow, Sonic Business Integration Suite, Sonic Process Manager, Sonic Collaboration Server, Sonic Continuous Availability Architecture, Sonic Database Service, Sonic Workbench, Sonic XML Server, The Brains Behind BAM, WebClient, and Who Makes Progress are trademarks or service marks of Progress Software Corporation and/or its subsidiaries or affiliates in the U.S. and other countries. Java is a registered trademark of Oracle and/or its affiliates. Any other marks contained herein may be trademarks of their respective owners.

### **Third Party Acknowledgments:**

Progress Artix ESB for C++ v5.6 incorporates Xalan v2.3.1 technologies from the Apache Software Foundation (<http://www.apache.org>). Such Apache technologies are subject to the following terms and conditions: The Apache Software License, Version 1.1. Copyright (C) 1999-2002 The Apache Software Foundation. All rights reserved. Redistribution and use in source and binary forms, with or without modification, are permitted provided that the following conditions are met: 1. Redistributions of source code must retain the above copyright notice, this list of conditions and the following disclaimer. 2. Redistributions in binary form must reproduce the above copyright notice, this list of conditions and the following disclaimer in the documentation and/or other materials provided with the distribution. 3. The end-user documentation included with the redistribution, if any, must include the following acknowledgment: "This product includes software developed by the Apache Software Foundation (<http://www.apache.org>). Alternately, this acknowledgment may appear in the software itself, if and wherever such third-party acknowledgments normally appear. 4. The names "Ant", "Xerces," "Xalan," "Log 4J," and "Apache Software Foundation" must not be used to: endorse or promote products derived from this software without prior written permission. For written permission, please contact [apache@apache.org](mailto:apache@apache.org). 5. Products derived from this software may not be called "Apache", nor may "Apache" appear in their name, without prior written permission of the Apache Software Foundation. THIS SOFTWARE IS PROVIDED "AS IS" AND ANY EXPRESSED OR IMPLIED WARRANTIES, INCLUDING, BUT NOT LIMITED TO, THE IMPLIED WARRANTIES OF MERCHANTABILITY AND FITNESS FOR A PARTICULAR PURPOSE ARE DISCLAIMED. IN NO EVENT SHALL THE APACHE SOFTWARE FOUNDATION OR ITS CONTRIBUTORS BE LIABLE FOR ANY DIRECT, INDIRECT, INCIDENTAL, SPECIAL, EXEMPLARY, OR CONSEQUENTIAL DAMAGES (INCLUDING, BUT NOT LIMITED TO, PROCUREMENT OF SUBSTITUTE GOODS OR SERVICES; LOSS OF USE, DATA, OR PROFITS; OR BUSINESS INTERRUPTION) HOWEVER CAUSED AND ON ANY THEORY OF LIABILITY, WHETHER IN CONTRACT, STRICT LIABILITY, OR TORT (INCLUDING NEGLIGENCE OR OTHERWISE) ARISING IN ANY WAY OUT OF THE USE OF THIS SOFTWARE, EVEN IF ADVISED OF THE POSSIBILITY OF SUCH DAMAGE. This software consists of voluntary contributions made by many individuals on behalf of the Apache Software Foundation. For more information on the Apache Software Foundation, please see <http://www.apache.org/>. Xalan was originally based on software copyright (c) 1999, Lotus Development Corporation., <http://www.lotus.com>. Xerces was originally based on software copyright (c) 1999, International Business Machines, Inc., <http://www.ibm.com>.

Progress Artix ESB for C++ v5.6 incorporates Xerces C++ v2.4 technology from the Apache Software Foundation (<http://www.apache.org>). Such Apache technology is subject to the following terms and conditions: The Apache Software License, Version 1.1 - Copyright (c) 1999-2001 The Apache Software Foundation. All rights reserved. Redistribution and use in source and binary forms, with or without modification, are permitted provided that the following conditions are met:

1. Redistributions of source code must retain the above copyright notice, this list of conditions and the following disclaimer.

2. Redistributions in binary form must reproduce the above copyright notice, this list of conditions and the following disclaimer in the documentation and/or other materials provided with the distribution.

3. The end-user documentation included with the redistribution, if any, must include the following acknowledgment: "This product includes software developed by the Apache Software Foundation (<http://www.apache.org/>)." Alternately, this acknowledgment may appear in the software itself, if and wherever such third-party acknowledgments normally appear.

4. The names "Xerces" and "Apache Software Foundation" must not be used to endorse or promote products derived from this software without prior written permission. For written permission, please contact [apache@apache.org](mailto:apache@apache.org).

5. Products derived from this software may not be called "Apache", nor may "Apache" appear in their name, without prior written permission of the Apache Software Foundation.

THIS SOFTWARE IS PROVIDED ``AS IS" AND ANY EXPRESSED OR IMPLIED WARRANTIES, INCLUDING, BUT NOT LIMITED TO, THE IMPLIED WARRANTIES OF MERCHANTABILITY AND FITNESS FOR A PARTICULAR PURPOSE ARE DISCLAIMED. IN NO EVENT SHALL THE APACHE SOFTWARE FOUNDATION OR ITS CONTRIBUTORS BE LIABLE FOR ANY DIRECT, INDIRECT, INCIDENTAL, SPECIAL, EXEMPLARY, OR CONSEQUENTIAL DAMAGES (INCLUDING, BUT NOT LIMITED TO, PROCUREMENT OF SUBSTITUTE GOODS OR SERVICES; LOSS OF USE, DATA, OR PROFITS; OR BUSINESS INTERRUPTION) HOWEVER CAUSED AND ON ANY THEORY OF LIABILITY, WHETHER IN CONTRACT, STRICT LIABILITY, OR TORT (INCLUDING NEGLIGENCE OR OTHERWISE) ARISING IN ANY WAY OUT OF THE USE OF THIS SOFTWARE, EVEN IF ADVISED OF THE POSSIBILITY OF SUCH DAMAGE.

Progress Artix ESB for C++ v5.6 incorporates Apache Xerces v2.5.0 technology from the Apache Software Foundation ([http://www.apache.org](http://www.apache.org/)). Such Apache technology is subject to the following terms and conditions: The Apache Software License, Version 1.1 - Copyright (c) 1999-2002 The Apache Software Foundation. All rights reserved. Redistribution and use in source and binary forms, with or without modification, are permitted provided that the following conditions are met:

1. Redistributions of source code must retain the above copyright notice, this list of conditions and the following disclaimer.

2. Redistributions in binary form must reproduce the above copyright notice, this list of conditions and the following disclaimer in the documentation and/or other materials provided with the distribution.

3. The end-user documentation included with the redistribution, if any, must include the following acknowledgment: "This product includes software developed by the Apache Software Foundation (<http://www.apache.org/>)." Alternately, this acknowledgment may appear in the software itself, if and wherever such third-party acknowledgments normally appear.

4. The names "Xerces" and "Apache Software Foundation" must not be used to endorse or promote products derived from this software without prior written permission. For written permission, please contact [apache@apache.org](mailto:apache@apache.org).

5. Products derived from this software may not be called "Apache", nor may "Apache" appear in their name, without prior written permission of the Apache Software Foundation.

THIS SOFTWARE IS PROVIDED ``AS IS" AND ANY EXPRESSED OR IMPLIED WARRANTIES, INCLUDING, BUT NOT LIMITED TO, THE IMPLIED WARRANTIES OF MERCHANTABILITY AND FITNESS FOR A PARTICULAR PURPOSE ARE DISCLAIMED. IN NO EVENT SHALL THE APACHE SOFTWARE FOUNDATION OR ITS CONTRIBUTORS BE LIABLE FOR ANY DIRECT, INDIRECT, INCIDENTAL, SPECIAL, EXEMPLARY, OR CONSEQUENTIAL DAMAGES (INCLUDING, BUT NOT LIMITED TO, PROCUREMENT OF SUBSTITUTE GOODS OR SERVICES; LOSS OF USE, DATA, OR PROFITS; OR BUSINESS INTERRUPTION) HOWEVER CAUSED AND ON ANY THEORY OF LIABILITY, WHETHER IN CONTRACT, STRICT LIABILITY, OR TORT (INCLUDING NEGLIGENCE OR OTHERWISE) ARISING IN ANY WAY OUT OF THE USE OF THIS SOFTWARE, EVEN IF ADVISED OF THE POSSIBILITY OF SUCH DAMAGE.

This software consists of voluntary contributions made by many individuals on behalf of the Apache Software Foundation and was originally based on software copyright (c) 1999, International Business Machines, Inc., <http://www.ibm.com>. For more information on the Apache Software Foundation, please see <http://www.apache.org/>.

Progress Artix ESB for C++ v5.6 incorporates Xerces C++ v1.7 technology from the Apache Software Foundation (<http://www.apache.org>). Such Apache technology is subject to the following terms and conditions: The Apache Software License, Version 1.1. - Copyright (c) 1999-2004 The Apache Software Foundation. All rights reserved. Redistribution and use in source and binary forms, with or without modification, are permitted provided that the following conditions are met:

1. Redistributions of source code must retain the above copyright notice, this list of conditions and the following disclaimer.
2. Redistributions in binary form must reproduce the above copyright notice, this list of conditions and the following disclaimer in the documentation and/or other materials provided with the distribution.
3. The end-user documentation included with the redistribution, if any, must include the following acknowledgment: "This product includes software developed by the Apache Software Foundation (<http://www.apache.org/>)." Alternately, this acknowledgment may appear in the software itself, if and wherever such third-party acknowledgments normally appear.
4. The names "Xalan" and "Apache Software Foundation" must not be used to endorse or promote products derived from this software without prior written permission. For written permission, please contact [apache@apache.org](mailto:apache@apache.org).
5. Products derived from this software may not be called "Apache", nor may "Apache" appear in their name, without prior written permission of the Apache Software Foundation.

THIS SOFTWARE IS PROVIDED ``AS IS" AND ANY EXPRESSED OR IMPLIED WARRANTIES, INCLUDING, BUT NOT LIMITED TO, THE IMPLIED WARRANTIES OF MERCHANTABILITY AND FITNESS FOR A PARTICULAR PURPOSE ARE DISCLAIMED. IN NO EVENT SHALL THE APACHE SOFTWARE FOUNDATION OR ITS CONTRIBUTORS BE LIABLE FOR ANY DIRECT, INDIRECT, INCIDENTAL, SPECIAL, EXEMPLARY, OR CONSEQUENTIAL DAMAGES (INCLUDING, BUT NOT LIMITED TO, PROCUREMENT OF SUBSTITUTE GOODS OR SERVICES; LOSS OF USE, DATA, OR PROFITS; OR BUSINESS INTERRUPTION) HOWEVER CAUSED AND ON ANY THEORY OF LIABILITY, WHETHER IN CONTRACT, STRICT LIABILITY, OR TORT (INCLUDING NEGLIGENCE OR OTHERWISE) ARISING

ING IN ANY WAY OUT OF THE USE OF THIS SOFTWARE, EVEN IF ADVISED OF THE POSSIBILITY OF SUCH DAMAGE.

This software consists of voluntary contributions made by many individuals on behalf of the Apache Software Foundation and was originally based on software copyright (c) 1999, Lotus Development Corporation., <http://www.lotus.com>. For more information on the Apache Software Foundation, please see <http://www.apache.org/>.

Progress Artix ESB for C++ v5.6 incorporates Apache Velocity v1.3 technology from the Apache Software Foundation (<http://www.apache.org>). Such Apache technology is subject to the following terms and conditions: The Apache Software License, Version 1.1 - Copyright (c) 2000-2003 The Apache Software Foundation. All rights reserved. Redistribution and use in source and binary forms, with or without modification, are permitted provided that the following conditions are met:

1. Redistributions of source code must retain the above copyright notice, this list of conditions and the following disclaimer.

2. Redistributions in binary form must reproduce the above copyright notice, this list of conditions and the following disclaimer in the documentation and/or other materials provided with the distribution.

3. The end-user documentation included with the redistribution, if any, must include the following acknowledgement: "This product includes software developed by the Apache Software Foundation (<http://www.apache.org/>)." Alternately, this acknowledgement may appear in the software itself, if and wherever such third-party acknowledgements normally appear.

4. The names "The Jakarta Project", "Velocity", and "Apache Software Foundation" must not be used to endorse or promote products derived from this software without prior written permission. For written permission, please contact [apache@apache.org](mailto:apache@apache.org).

5. Products derived from this software may not be called "Apache", "Velocity" nor may "Apache" appear in their names without prior written permission of the Apache Group.

THIS SOFTWARE IS PROVIDED ``AS IS" AND ANY EXPRESSED OR IMPLIED WARRANTIES, INCLUDING, BUT NOT LIMITED TO, THE IMPLIED WARRANTIES OF MERCHANTABILITY AND FITNESS FOR A PARTICULAR PURPOSE ARE DISCLAIMED. IN NO EVENT SHALL THE APACHE SOFTWARE FOUNDATION OR ITS CONTRIBUTORS BE LIABLE FOR ANY DIRECT, INDIRECT, INCIDENTAL, SPECIAL, EXEMPLARY, OR CONSEQUENTIAL DAMAGES (INCLUDING, BUT NOT LIMITED TO, PROCUREMENT OF SUBSTITUTE GOODS OR SERVICES; LOSS OF USE, DATA, OR PROFITS; OR BUSINESS INTERRUPTION) HOWEVER CAUSED AND ON ANY THEORY OF LIABILITY, WHETHER IN CONTRACT, STRICT LIABILITY, OR TORT (INCLUDING NEGLIGENCE OR OTHERWISE) ARISING IN ANY WAY OUT OF THE USE OF THIS SOFTWARE, EVEN IF ADVISED OF THE POSSIBILITY OF SUCH DAMAGE.

Progress Artix ESB for C++ v5.6 incorporates Log4J v1.2.6 technology from the Apache Software Foundation (<http://www.apache.org>). Such Apache technology is subject to the following terms and conditions: The Apache Software License, Version 1.1 - Copyright (C) 1999 The Apache Software Foundation. All rights reserved. Redistribution and use in

source and binary forms, with or without modification, are permitted provided that the following conditions are met:

1. Redistributions of source code must retain the above copyright notice, this list of conditions and the following disclaimer.

2. Redistributions in binary form must reproduce the above copyright notice, this list of conditions and the following disclaimer in the documentation and/or other materials provided with the distribution.

3. The end-user documentation included with the redistribution, if any, must include the following acknowledgment: "This product includes software developed by the Apache Software Foundation (<http://www.apache.org/>)." Alternately, this acknowledgment may appear in the software itself, if and wherever such third-party acknowledgments normally appear.

4. The names "log4j" and "Apache Software Foundation" must not be used to endorse or promote products derived from this software without prior written permission. For written permission, please contact [apache@apache.org](mailto:apache@apache.org).

5. Products derived from this software may not be called "Apache", nor may "Apache" appear in their name, without prior written permission of the Apache Software Foundation.

THIS SOFTWARE IS PROVIDED ``AS IS'' AND ANY EXPRESSED OR IMPLIED WARRANTIES, INCLUDING, BUT NOT LIMITED TO, THE IMPLIED WARRANTIES OF MERCHANTABILITY AND FITNESS FOR A PARTICULAR PURPOSE ARE DISCLAIMED. IN NO EVENT SHALL THE APACHE SOFTWARE FOUNDATION OR ITS CONTRIBUTORS BE LIABLE FOR ANY DIRECT, INDIRECT, INCIDENTAL, SPECIAL, EXEMPLARY, OR CONSEQUENTIAL DAMAGES (INCLUDING, BUT NOT LIMITED TO, PROCUREMENT OF SUBSTITUTE GOODS OR SERVICES; LOSS OF USE, DATA, OR PROFITS; OR BUSINESS INTERRUPTION) HOWEVER CAUSED AND ON ANY THEORY OF LIABILITY, WHETHER IN CONTRACT, STRICT LIABILITY, OR TORT (INCLUDING NEGLIGENCE OR OTHERWISE) ARISING IN ANY WAY OUT OF THE USE OF THIS SOFTWARE, EVEN IF ADVISED OF THE POSSIBILITY OF SUCH DAMAGE.

This software consists of voluntary contributions made by many individuals on behalf of the Apache Software Foundation. For more information on the Apache Software Foundation, please see <http://www.apache.org/>.

(a) Progress Artix ESB for C++ v5.6 incorporates JDOM Beta 9 technology from JDOM. Such technology is subject to the following terms and conditions: Copyright (C) 2000-2004 Jason Hunter & Brett McLaughlin. All rights reserved. Redistribution and use in source and binary forms, with or without modification, are permitted provided that the following conditions are met: 1. Redistributions of source code must retain the above copyright notice, this list of conditions, and the following disclaimer. 2. Redistributions in binary form must reproduce the above copyright notice, this list of conditions, and the disclaimer that follows these conditions in the documentation and/or other materials provided with the distribution. 3. The name "JDOM" must not be used to endorse or promote products derived from this software without prior written permission. For written permission, please contact [request\\_AT\\_jdom\\_DOT\\_org](mailto:request_AT_jdom_DOT_org). 4. Products derived from this software may not be called "JDOM", nor may "JDOM" appear in their name, without prior written permission from the JDOM Project Management [request\\_AT\\_jdom\\_DOT\\_org](mailto:request_AT_jdom_DOT_org). In addition, we request (but do not require) that you include in the end-user documentation provided with the redistribution and/or in the software itself an acknowledgement equivalent to the following: "This

product includes software developed by the JDOM Project (<http://www.jdom.org/>).<sup>1</sup> Alternatively, the acknowledgment may be graphical using the logos available at <http://www.jdom.org/images/logos>. THIS SOFTWARE IS PROVIDED AS IS AND ANY EXPRESSED OR IMPLIED WARRANTIES, INCLUDING, BUT NOT LIMITED TO, THE IMPLIED WARRANTIES OF MERCHANTABILITY AND FITNESS FOR A PARTICULAR PURPOSE ARE DISCLAIMED. IN NO EVENT SHALL THE JDOM AUTHORS OR THE PROJECT CONTRIBUTORS BE LIABLE FOR ANY DIRECT, INDIRECT, INCIDENTAL, SPECIAL, EXEMPLARY, OR CONSEQUENTIAL DAMAGES (INCLUDING, BUT NOT LIMITED TO, PROCUREMENT OF SUBSTITUTE GOODS OR SERVICES; LOSS OF USE, DATA, OR PROFITS; OR BUSINESS INTERRUPTION) HOWEVER CAUSED AND ON ANY THEORY OF LIABILITY, WHETHER IN CONTRACT, STRICT LIABILITY, OR TORT (INCLUDING NEGLIGENCE OR OTHERWISE) ARISING IN ANY WAY OUT OF THE USE OF THIS SOFTWARE, EVEN IF ADVISED OF THE POSSIBILITY OF SUCH DAMAGE. This software consists of voluntary contributions made by many individuals on behalf of the JDOM Project and was originally created by Jason Hunter <jhunter\_AT\_jdom\_DOT\_org> and Brett McLaughlin <brett\_AT\_jdom\_DOT\_org>. For more information on the JDOM Project, please see <<http://www.jdom.org/>>

Progress Artix ESB for C++ v5.6 incorporates IBM-ICU v2.6 and IBM-ICU v2.6.1 technologies from IBM. Such technologies are subject to the following terms and conditions: Copyright (c) 1995-2003 International Business Machines Corporation and others All rights reserved. Permission is hereby granted, free of charge, to any person obtaining a copy of this software and associated documentation files (the "Software"), to deal in the Software without restriction, including without limitation the rights to use, copy, modify, merge, publish, distribute, and/or sell copies of the Software, and to permit persons to whom the Software is furnished to do so, provided that the above copyright notice(s) and this permission notice appear in all copies of the Software and that both the above copyright notice(s) and this permission notice appear in supporting documentation. THE SOFTWARE IS PROVIDED "AS IS", WITHOUT WARRANTY OF ANY KIND, EXPRESS OR IMPLIED, INCLUDING BUT NOT LIMITED TO THE WARRANTIES OF MERCHANTABILITY, FITNESS FOR A PARTICULAR PURPOSE AND NONINFRINGEMENT OF THIRD PARTY RIGHTS. IN NO EVENT SHALL THE COPYRIGHT HOLDER OR HOLDERS INCLUDED IN THIS NOTICE BE LIABLE FOR ANY CLAIM, OR ANY SPECIAL INDIRECT OR CONSEQUENTIAL DAMAGES, OR ANY DAMAGES WHATSOEVER RESULTING FROM LOSS OF USE, DATA OR PROFITS, WHETHER IN AN ACTION OF CONTRACT, NEGLIGENCE OR OTHER TORTIOUS ACTION, ARISING OUT OF OR IN CONNECTION WITH THE USE OR PERFORMANCE OF THIS SOFTWARE. Except as contained in this notice, the name of a copyright holder shall not be used in advertising or otherwise to promote the sale, use or other dealings in this Software without prior written authorization of the copyright holder. All trademarks and registered trademarks mentioned herein are the property of their respective owners.

Progress Artix ESB for C++ v5.6 incorporates John Wilson MinML v1.7 technology from John Wilson. Such technology is subject to the following terms and conditions: Copyright (c) 1999, John Wilson ([tug@wilson.co.uk](mailto:tug@wilson.co.uk)). All rights reserved. Redistribution and use in source and binary forms, with or without modification, are permitted provided that the following conditions are met: Redistributions of source code must retain the above copyright



notice, this list of conditions and the following disclaimer. Redistributions in binary form must reproduce the above copyright notice, this list of conditions and the following disclaimer in the documentation and/or other materials provided with the distribution. All advertising materials mentioning features or use of this software must display the following acknowledgement: This product includes software developed by John Wilson. The name of John Wilson may not be used to endorse or promote products derived from this software without specific prior written permission. THIS SOFTWARE IS PROVIDED BY JOHN WILSON ``AS IS" AND ANY EXPRESS OR IMPLIED WARRANTIES, INCLUDING, BUT NOT LIMITED TO, THE IMPLIED WARRANTIES OF MERCHANTABILITY AND FITNESS FOR A PARTICULAR PURPOSE ARE DISCLAIMED. IN NO EVENT SHALL JOHN WILSON BE LIABLE FOR ANY DIRECT, INDIRECT, INCIDENTAL, SPECIAL, EXEMPLARY, OR CONSEQUENTIAL DAMAGES (INCLUDING, BUT NOT LIMITED TO, PROCUREMENT OF SUBSTITUTE GOODS OR SERVICES; LOSS OF USE, DATA, OR PROFITS; OR BUSINESS INTERRUPTION) HOWEVER CAUSED AND ON ANY THEORY OF LIABILITY, WHETHER IN CONTRACT, STRICT LIABILITY, OR TORT (INCLUDING NEGLIGENCE OR OTHERWISE) ARISING IN ANY WAY OUT OF THE USE OF THIS SOFTWARE, EVEN IF ADVISED OF THE POSSIBILITY OF SUCH DAMAGE.

Progress Artix ESB for C++ v5.6 incorporates SourceForge - NET-SNMP v5.0.7 technology from SourceForge and Networks Associates Technology, Inc. Such technology is subject to the following terms and conditions: Various copyrights apply to this package, listed in various separate parts below. Please make sure that you read all the parts. Up until 2001, the project was based at UC Davis, and the first part covers all code written during this time. From 2001 onwards, the project has been based at SourceForge, and Networks Associates Technology, Inc hold the copyright on behalf of the wider Net-SNMP community, covering all derivative work done since then. An additional copyright section has been added as Part 3 below also under a BSD license for the work contributed by Cambridge Broadband Ltd. to the project since 2001. An additional copyright section has been added as Part 4 below also under a BSD license for the work contributed by Sun Microsystems, Inc. to the project since 2003. Code has been contributed to this project by many people over the years it has been in development, and a full list of contributors can be found in the README file under the THANKS section. ---- Part 1: CMU/UCD copyright notice: (BSD like) ---- Copyright 1989, 1991, 1992 by Carnegie Mellon University. Derivative Work - 1996, 1998-2000. Copyright 1996, 1998-2000 The Regents of the University of California. All Rights Reserved. Permission to use, copy, modify and distribute this software and its documentation for any purpose and without fee is hereby granted, provided that the above copyright notice appears in all copies and that both that copyright notice and this permission notice appear in supporting documentation, and that the name of CMU and The Regents of the University of California not be used in advertising or publicity pertaining to distribution of the software without specific written permission. CMU AND THE REGENTS OF THE UNIVERSITY OF CALIFORNIA DISCLAIM ALL WARRANTIES WITH REGARD TO THIS SOFTWARE, INCLUDING ALL IMPLIED WARRANTIES OF MERCHANTABILITY AND FITNESS. IN NO EVENT SHALL CMU OR THE REGENTS OF THE UNIVERSITY OF CALIFORNIA BE LIABLE FOR ANY SPECIAL, INDIRECT OR CONSEQUENTIAL DAMAGES OR ANY DAMAGES WHATSOEVER RESULTING FROM THE LOSS OF USE, DATA OR PROFITS, WHETHER IN AN ACTION OF CONTRACT, NEGLIGENCE OR OTHER TORTIOUS ACTION, ARISING OUT OF OR

IN CONNECTION WITH THE USE OR PERFORMANCE OF THIS SOFTWARE. ---- Part 2: Networks Associates Technology, Inc copyright notice (BSD) ----- Copyright (c) 2001-2003, Networks Associates Technology, Inc. All rights reserved. Redistribution and use in source and binary forms, with or without modification, are permitted provided that the following conditions are met: \*Redistributions of source code must retain the above copyright notice, this list of conditions and the following disclaimer.\* Redistributions in binary form must reproduce the above copyright notice, this list of conditions and the following disclaimer in the documentation and/or other materials provided with the distribution.\* Neither the name of the Networks Associates Technology, Inc nor the names of its contributors may be used to endorse or promote products derived from this software without specific prior written permission. THIS SOFTWARE IS PROVIDED BY THE COPYRIGHT HOLDERS AND CONTRIBUTORS ``AS IS" AND ANY EXPRESS OR IMPLIED WARRANTIES, INCLUDING, BUT NOT LIMITED TO, THE IMPLIED WARRANTIES OF MERCHANTABILITY AND FITNESS FOR A PARTICULAR PURPOSE ARE DISCLAIMED. IN NO EVENT SHALL THE COPYRIGHT HOLDERS OR CONTRIBUTORS BE LIABLE FOR ANY DIRECT, INDIRECT, INCIDENTAL, SPECIAL, EXEMPLARY, OR CONSEQUENTIAL DAMAGES (INCLUDING, BUT NOT LIMITED TO, PROCUREMENT OF SUBSTITUTE GOODS OR SERVICES; LOSS OF USE, DATA, OR PROFITS; OR BUSINESS INTERRUPTION) HOWEVER CAUSED AND ON ANY THEORY OF LIABILITY, WHETHER IN CONTRACT, STRICT LIABILITY, OR TORT (INCLUDING NEGLIGENCE OR OTHERWISE) ARISING IN ANY WAY OUT OF THE USE OF THIS SOFTWARE, EVEN IF ADVISED OF THE POSSIBILITY OF SUCH DAMAGE. ---- Part 3: Cambridge Broadband Ltd. copyright notice (BSD) ----- Portions of this code are copyright (c) 2001-2003, Cambridge Broadband Ltd. All rights reserved. Redistribution and use in source and binary forms, with or without modification, are permitted provided that the following conditions are met:\*Redistributions of source code must retain the above copyright notice, this list of conditions and the following disclaimer.\* Redistributions in binary form must reproduce the above copyright notice, this list of conditions and the following disclaimer in the documentation and/or other materials provided with the distribution.\* The name of Cambridge Broadband Ltd. may not be used to endorse or promote products derived from this software without specific prior written permission. THIS SOFTWARE IS PROVIDED BY THE COPYRIGHT HOLDER ``AS IS" AND ANY EXPRESS OR IMPLIED WARRANTIES, INCLUDING, BUT NOT LIMITED TO, THE IMPLIED WARRANTIES OF MERCHANTABILITY AND FITNESS FOR A PARTICULAR PURPOSE ARE DISCLAIMED. IN NO EVENT SHALL THE COPYRIGHT HOLDER BE LIABLE FOR ANY DIRECT, INDIRECT, INCIDENTAL, SPECIAL, EXEMPLARY, OR CONSEQUENTIAL DAMAGES (INCLUDING, BUT NOT LIMITED TO, PROCUREMENT OF SUBSTITUTE GOODS OR SERVICES; LOSS OF USE, DATA, OR PROFITS; OR BUSINESS INTERRUPTION) HOWEVER CAUSED AND ON ANY THEORY OF LIABILITY, WHETHER IN CONTRACT, STRICT LIABILITY, OR TORT (INCLUDING NEGLIGENCE

OR OTHERWISE) ARISING IN ANY WAY OUT OF THE USE OF THIS SOFTWARE, EVEN IF ADVISED OF THE POSSIBILITY OF SUCH DAMAGE. ---- Part 4: Sun Microsystems, Inc. copyright notice (BSD) -----Copyright © 2003 Sun Microsystems, Inc., 4150 Network Circle, Santa Clara, California 95054, U.S.A. All rights reserved. Use is subject to license terms below. This distribution may include materials developed by third parties. Sun, Sun Microsystems, the Sun logo and Solaris are trademarks or registered trademarks of Sun Microsystems, Inc. in the U.S. and other countries. Redistribution and use in source and binary forms, with or without modification, are permitted provided that the fol-

lowing conditions are met:\* Redistributions of source code must retain the above copyright notice, this list of conditions and the following disclaimer.\* Redistributions in binary form must reproduce the above copyright notice, this list of conditions and the following disclaimer in the documentation and/or other materials provided with the distribution.\* Neither the name of the Sun Microsystems, Inc. nor the names of its contributors may be used to endorse or promote products derived from this software without specific prior written permission. THIS SOFTWARE IS PROVIDED BY THE COPYRIGHT HOLDERS AND CONTRIBUTORS ``AS IS" AND ANY EXPRESS OR IMPLIED WARRANTIES, INCLUDING, BUT NOT LIMITED TO, THE IMPLIED WARRANTIES OF MERCHANTABILITY AND FITNESS FOR A PARTICULAR PURPOSE ARE DISCLAIMED. IN NO EVENT SHALL THE COPYRIGHT HOLDERS OR CONTRIBUTORS BE LIABLE FOR ANY DIRECT, INDIRECT, INCIDENTAL, SPECIAL, EXEMPLARY, OR CONSEQUENTIAL DAMAGES (INCLUDING, BUT NOT LIMITED TO, PROCUREMENT OF SUBSTITUTE GOODS OR SERVICES; LOSS OF USE, DATA, OR PROFITS; OR BUSINESS INTERRUPTION) HOWEVER CAUSED AND ON ANY THEORY OF LIABILITY, WHETHER IN CONTRACT, STRICT LIABILITY, OR TORT (INCLUDING NEGLIGENCE OR OTHERWISE) ARISING IN ANY WAY OUT OF THE USE OF THIS SOFTWARE, EVEN IF ADVISED OF THE POSSIBILITY OF SUCH DAMAGE. ---- Part 5: Sparta, Inc copyright notice (BSD) -----Copyright (c) 2003-2005, Sparta, Inc. All rights reserved. Redistribution and use in source and binary forms, with or without modification, are permitted provided that the following conditions are met:\* Redistributions of source code must retain the above copyright notice, this list of conditions and the following disclaimer.\* Redistributions in binary form must reproduce the above copyright notice, this list of conditions and the following disclaimer in the documentation and/or other materials provided with the distribution.\* Neither the name of Sparta, Inc nor the names of its contributors may be used to endorse or promote products derived from this software without specific prior written permission. THIS SOFTWARE IS PROVIDED BY THE COPYRIGHT HOLDERS AND CONTRIBUTORS ``AS IS" AND ANY EXPRESS OR IMPLIED WARRANTIES, INCLUDING, BUT NOT LIMITED TO, THE IMPLIED WARRANTIES OF MERCHANTABILITY AND FITNESS FOR A PARTICULAR PURPOSE ARE DISCLAIMED. IN NO EVENT SHALL THE COPYRIGHT HOLDERS OR CONTRIBUTORS BE LIABLE FOR ANY DIRECT, INDIRECT, INCIDENTAL, SPECIAL, EXEMPLARY, OR CONSEQUENTIAL DAMAGES (INCLUDING, BUT NOT LIMITED TO, PROCUREMENT OF SUBSTITUTE GOODS OR SERVICES; LOSS OF USE, DATA, OR PROFITS; OR BUSINESS INTERRUPTION) HOWEVER CAUSED AND ON ANY THEORY OF LIABILITY, WHETHER IN CONTRACT, STRICT LIABILITY, OR TORT (INCLUDING NEGLIGENCE OR OTHERWISE) ARISING IN ANY WAY OUT OF THE USE OF THIS SOFTWARE, EVEN IF ADVISED OF THE POSSIBILITY OF SUCH DAMAGE. ---- Part 6: Cisco/BUPTNIC copyright notice (BSD) ----- Copyright (c) 2004, Cisco, Inc and Information Network Center of Beijing University of Posts and Telecommunications. All rights reserved. Redistribution and use in source and binary forms, with or without modification, are permitted provided that the following conditions are met:\* Redistributions of source code must retain the above copyright notice, this list of conditions and the following disclaimer. \* Redistributions in binary form must reproduce the above copyright notice, this list of conditions and the following disclaimer in the documentation and/or other materials provided with the distribution. \* Neither the name of Cisco, Inc, Beijing University of Posts and Telecommunications, nor the names of their contributors may be used to endorse or promote products derived from this software without specific prior written permission. THIS SOFTWARE IS

PROVIDED BY THE COPYRIGHT HOLDERS AND CONTRIBUTORS ``AS IS" AND ANY EXPRESS OR IMPLIED WARRANTIES, INCLUDING, BUT NOT LIMITED TO, THE IMPLIED WARRANTIES OF MERCHANTABILITY AND FITNESS FOR A PARTICULAR PURPOSE ARE DISCLAIMED. IN NO EVENT SHALL THE COPYRIGHT HOLDERS OR CONTRIBUTORS BE LIABLE FOR ANY DIRECT, INDIRECT, INCIDENTAL, SPECIAL, EXEMPLARY, OR CONSEQUENTIAL DAMAGES (INCLUDING, BUT NOT LIMITED TO, PROCUREMENT OF SUBSTITUTE GOODS OR SERVICES; LOSS OF USE, DATA, OR PROFITS; OR BUSINESS INTERRUPTION) HOWEVER CAUSED AND ON ANY THEORY OF LIABILITY, WHETHER IN CONTRACT, STRICT LIABILITY, OR TORT (INCLUDING NEGLIGENCE OR OTHERWISE) ARISING IN ANY WAY OUT OF THE USE OF THIS SOFTWARE, EVEN IF ADVISED OF THE POSSIBILITY OF SUCH DAMAGE. ---- Part 7: Fabasoft R&D Software GmbH & Co KG copyright notice (BSD) ----- Copyright (c) Fabasoft R&D Software GmbH & Co KG, 2003 oss@fabasoft.com Author: Bernhard Penz. Redistribution and use in source and binary forms, with or without modification, are permitted provided that the following conditions are met:\* Redistributions of source code must retain the above copyright notice, this list of conditions and the following disclaimer.\* Redistributions in binary form must reproduce the above copyright notice, this list of conditions and the following disclaimer in the documentation and/or other materials provided with the distribution. \* The name of Fabasoft R&D Software GmbH & Co KG or any of its subsidiaries, brand or product names may not be used to endorse or promote products derived from this software without specific prior written permission. THIS SOFTWARE IS PROVIDED BY THE COPYRIGHT HOLDER ``AS IS" AND ANY EXPRESS OR IMPLIED WARRANTIES, INCLUDING, BUT NOT LIMITED TO, THE IMPLIED WARRANTIES OF MERCHANTABILITY AND FITNESS FOR A PARTICULAR PURPOSE ARE DISCLAIMED. IN NO EVENT SHALL THE COPYRIGHT HOLDER BE LIABLE FOR ANY DIRECT, INDIRECT, INCIDENTAL, SPECIAL, EXEMPLARY, OR CONSEQUENTIAL DAMAGES (INCLUDING, BUT NOT LIMITED TO, PROCUREMENT OF SUBSTITUTE GOODS OR SERVICES; LOSS OF USE, DATA, OR PROFITS; OR BUSINESS INTERRUPTION) HOWEVER CAUSED AND ON ANY THEORY OF LIABILITY, WHETHER IN CONTRACT, STRICT LIABILITY, OR TORT (INCLUDING NEGLIGENCE OR OTHERWISE) ARISING IN ANY WAY OUT OF THE USE OF THIS SOFTWARE, EVEN IF ADVISED OF THE POSSIBILITY OF SUCH DAMAGE.

Progress Artix ESB for C++ v5.6 incorporates OpenSSL/SSLey v0.9.8i technology from OpenSSL.org. Such Technology is subject to the following terms and conditions: LICENSE ISSUES =====

The OpenSSL toolkit stays under a dual license, i.e. both the conditions of the OpenSSL License and the original SSLey license apply to the toolkit. See below for the actual license texts. Actually both licenses are BSD-style Open Source licenses. In case of any license issues related to OpenSSL please contact openssl-core@openssl.org.

OpenSSL License -----

/\*

=====  
=====

Copyright (c) 1998-2008 The OpenSSL Project. All rights reserved. Redistribution and use in source and binary forms, with or without modification, are permitted provided that the following conditions are met:

1. Redistributions of source code must retain the above copyright notice, this list of conditions and the following disclaimer.
2. Redistributions in binary form must reproduce the above copyright notice, this list of conditions and the following disclaimer in the documentation and/or other materials provided with the distribution.
3. All advertising materials mentioning features or use of this software must display the following acknowledgment: "This product includes software developed by the OpenSSL Project for use in the OpenSSL Toolkit. (<http://www.openssl.org/>)"
4. The names "OpenSSL Toolkit" and "OpenSSL Project" must not be used to endorse or promote products derived from this software without prior written permission. For written permission, please contact [openssl-core@openssl.org](mailto:openssl-core@openssl.org).
5. Products derived from this software may not be called "OpenSSL" nor may "OpenSSL" appear in their names without prior written permission of the OpenSSL Project.
6. Redistributions of any form whatsoever must retain the following acknowledgment: "This product includes software developed by the OpenSSL Project for use in the OpenSSL Toolkit (<http://www.openssl.org/>)"

THIS SOFTWARE IS PROVIDED BY THE OpenSSL PROJECT ``AS IS" AND ANY EXPRESSED OR IMPLIED WARRANTIES, INCLUDING, BUT NOT LIMITED TO, THE IMPLIED WARRANTIES OF MERCHANTABILITY AND FITNESS FOR A PARTICULAR PURPOSE ARE DISCLAIMED. IN NO EVENT SHALL THE OpenSSL PROJECT OR ITS CONTRIBUTORS BE LIABLE FOR ANY DIRECT, INDIRECT, INCIDENTAL, SPECIAL, EXEMPLARY, OR CONSEQUENTIAL DAMAGES (INCLUDING, BUT NOT LIMITED TO, PROCUREMENT OF SUBSTITUTE GOODS OR SERVICES; LOSS OF USE, DATA, OR PROFITS; OR BUSINESS INTERRUPTION) HOWEVER CAUSED AND ON ANY THEORY OF LIABILITY, WHETHER IN CONTRACT, STRICT LIABILITY, OR TORT (INCLUDING NEGLIGENCE OR OTHERWISE) ARISING IN ANY WAY OUT OF THE USE OF THIS SOFTWARE, EVEN IF ADVISED OF THE POSSIBILITY OF SUCH DAMAGE.

=====  
=====

This product includes cryptographic software written by Eric Young ([ey@cryptsoft.com](mailto:ey@cryptsoft.com)).  
This product includes software written by Tim Hudson ([tjh@cryptsoft.com](mailto:tjh@cryptsoft.com)).

Original SSLeay License -----

Copyright (C) 1995-1998 Eric Young ([ey@cryptsoft.com](mailto:ey@cryptsoft.com)) All rights reserved.

This package is an SSL implementation written by Eric Young ([ey@cryptsoft.com](mailto:ey@cryptsoft.com)). The implementation was written so as to conform with Netscape's SSL. This library is free for commercial and non-commercial use as long as the following conditions are adhered to. The following conditions apply to all code found in this distribution, be it the RC4, RSA, lhash, DES, etc., code; not just the SSL code. The SSL documentation included with this distribution is covered by the same copyright terms except that the holder is Tim Hudson ([tjh@cryptsoft.com](mailto:tjh@cryptsoft.com)). Copyright remains Eric Young's, and as such any Copyright notices in the code are not to be removed. If this package is used in a product, Eric Young should be

given attribution as the author of the parts of the library used. This can be in the form of a textual message at program startup or in documentation (online or textual) provided with the package. Redistribution and use in source and binary forms, with or without modification, are permitted provided that the following conditions are met:

1. Redistributions of source code must retain the copyright notice, this list of conditions and the following disclaimer.
2. Redistributions in binary form must reproduce the above copyright notice, this list of conditions and the following disclaimer in the documentation and/or other materials provided with the distribution.
3. All advertising materials mentioning features or use of this software must display the following acknowledgement: "This product includes cryptographic software written by Eric Young (eay@cryptsoft.com)" The word 'cryptographic' can be left out if the routines from the library being used are not cryptographic related :-).
4. If you include any Windows specific code (or a derivative thereof) from the apps directory (application code) you must include an acknowledgement: "This product includes software written by Tim Hudson (tjh@cryptsoft.com)"

THIS SOFTWARE IS PROVIDED BY ERIC YOUNG ``AS IS" AND ANY EXPRESS OR IMPLIED WARRANTIES, INCLUDING, BUT NOT LIMITED TO, THE IMPLIED WARRANTIES OF MERCHANTABILITY AND FITNESS FOR A PARTICULAR PURPOSE ARE DISCLAIMED. IN NO EVENT SHALL THE AUTHOR OR CONTRIBUTORS BE LIABLE FOR ANY DIRECT, INDIRECT, INCIDENTAL, SPECIAL, EXEMPLARY, OR CONSEQUENTIAL DAMAGES (INCLUDING, BUT NOT LIMITED TO, PROCUREMENT OF SUBSTITUTE GOODS OR SERVICES; LOSS OF USE, DATA, OR PROFITS; OR BUSINESS INTERRUPTION) HOWEVER CAUSED AND ON ANY THEORY OF LIABILITY, WHETHER IN CONTRACT, STRICT LIABILITY, OR TORT (INCLUDING NEGLIGENCE OR OTHERWISE) ARISING IN ANY WAY OUT OF THE USE OF THIS SOFTWARE, EVEN IF ADVISED OF THE POSSIBILITY OF SUCH DAMAGE. The licence and distribution terms for any publically available version or derivative of this code cannot be changed. i.e. this code cannot simply be copied and put under another distribution licence [including the GNU Public Licence.]

Progress Artix ESB for C++ v5.6 incorporates Bouncycastle v1.3.3 cryptographic technology from the Legion Of The Bouncy Castle (<http://www.bouncycastle.org>). Such Bouncycastle 1.3.3 cryptographic technology is subject to the following terms and conditions: Copyright (c) 2000 - 2006 The Legion Of The Bouncy Castle (<http://www.bouncycastle.org>). Permission is hereby granted, free of charge, to any person obtaining a copy of this software and associated documentation files (the "Software"), to deal in the Software without restriction, including without limitation the rights to use, copy, modify, merge, publish, distribute, sublicense, and/or sell copies of the Software, and to permit persons to whom the Software is furnished to do so, subject to the following conditions: The above copyright notice and this permission notice shall be included in all copies or substantial portions of the Software. THE SOFTWARE IS PROVIDED "AS IS", WITHOUT WARRANTY OF ANY KIND, EXPRESS OR IMPLIED, INCLUDING BUT NOT LIMITED TO THE WARRANTIES OF MERCHANTABILITY, FITNESS FOR A PARTICULAR PURPOSE AND NONINFRINGEMENT. IN NO EVENT SHALL THE AUTHORS OR COPYRIGHT HOLDERS BE LIABLE FOR ANY CLAIM, DAMAGES OR OTHER LIABILITY, WHETHER IN AN ACTION OF CONTRACT, TORT OR OTHERWISE, ARISING

FROM, OUT OF OR IN CONNECTION WITH THE SOFTWARE OR THE USE OR OTHER DEALINGS IN THE SOFTWARE.

Progress Artix ESB for C++ v5.6 incorporates PCRE 7.8 from PCRE for the purpose of providing a set of functions that implement regular expression pattern matching using the same syntax and semantics as Perl 5. Such technology is subject to the following terms and conditions: PCRE LICENCE. PCRE is a library of functions to support regular expressions whose syntax and semantics are as close as possible to those of the Perl 5 language. Release 7 of PCRE is distributed under the terms of the "BSD" licence, as specified below. The documentation for PCRE, supplied in the "doc" directory, is distributed under the same terms as the software itself. The basic library functions are written in C and are freestanding. Also included in the distribution is a set of C++ wrapper functions. THE BASIC LIBRARY FUNCTIONS. Written by: Philip Hazel. Email local part: ph10. Email domain: cam.ac.uk. University of Cambridge Computing Service, Cambridge, England. Copyright (c) 1997-2008 University of Cambridge All rights reserved. THE C++ WRAPPER FUNCTIONS. Contributed by: Google Inc. Copyright (c) 2007-2008, Google Inc. All rights reserved. THE "BSD" LICENCE. Redistribution and use in source and binary forms, with or without modification, are permitted provided that the following conditions are met: \* Redistributions of source code must retain the above copyright notice, this list of conditions and the following disclaimer. \* Redistributions in binary form must reproduce the above copyright notice, this list of conditions and the following disclaimer in the documentation and/or other materials provided with the distribution. \* Neither the name of the University of Cambridge nor the name of Google Inc. nor the names of their contributors may be used to endorse or promote products derived from this software without specific prior written permission. THIS SOFTWARE IS PROVIDED BY THE COPYRIGHT HOLDERS AND CONTRIBUTORS "AS IS" AND ANY EXPRESS OR IMPLIED WARRANTIES, INCLUDING, BUT NOT LIMITED TO, THE IMPLIED WARRANTIES OF MERCHANTABILITY AND FITNESS FOR A PARTICULAR PURPOSE ARE DISCLAIMED. IN NO EVENT SHALL THE COPYRIGHT OWNER OR CONTRIBUTORS BE LIABLE FOR ANY DIRECT, INDIRECT, INCIDENTAL, SPECIAL, EXEMPLARY, OR CONSEQUENTIAL DAMAGES (INCLUDING, BUT NOT LIMITED TO, PROCUREMENT OF SUBSTITUTE GOODS OR SERVICES; LOSS OF USE, DATA, OR PROFITS; OR BUSINESS INTERRUPTION) HOWEVER CAUSED AND ON ANY THEORY OF LIABILITY, WHETHER IN CONTRACT, STRICT LIABILITY, OR TORT (INCLUDING NEGLIGENCE OR OTHERWISE) ARISING IN ANY WAY OUT OF THE USE OF THIS SOFTWARE, EVEN IF ADVISED OF THE POSSIBILITY OF SUCH DAMAGE.

Progress Artix ESB for C++ v5.6 incorporates mcpp v2.6.4 from Kiyoshi Matsui. Such technology is subject to the following terms and conditions: Copyright (c) 1998, 2002-2007 Kiyoshi Matsui kmatsui@t3.rim.or.jp All rights reserved. This software including the files in this directory is provided under the following license. Redistribution and use in source and binary forms, with or without modification, are permitted provided that the following conditions are met:

1. Redistributions of source code must retain the above copyright notice, this list of conditions and the following disclaimer.

2. Redistributions in binary form must reproduce the above copyright notice, this list of conditions and the following disclaimer in the documentation and/or other materials provided with the distribution.

THIS SOFTWARE IS PROVIDED BY THE AUTHOR ``AS IS" AND ANY EXPRESS OR IMPLIED WARRANTIES, INCLUDING, BUT NOT LIMITED TO, THE IMPLIED WARRANTIES OF MERCHANTABILITY AND FITNESS FOR A PARTICULAR PURPOSE ARE DISCLAIMED. IN NO EVENT SHALL THE AUTHOR BE LIABLE FOR ANY DIRECT, INDIRECT, INCIDENTAL, SPECIAL, EXEMPLARY, OR CONSEQUENTIAL DAMAGES (INCLUDING, BUT NOT LIMITED TO, PROCUREMENT OF SUBSTITUTE GOODS OR SERVICES; LOSS OF USE, DATA, OR PROFITS; OR BUSINESS INTERRUPTION) HOWEVER CAUSED AND ON ANY THEORY OF LIABILITY, WHETHER IN CONTRACT, STRICT LIABILITY, OR TORT (INCLUDING NEGLIGENCE OR OTHERWISE) ARISING IN ANY WAY OUT OF THE USE OF THIS SOFTWARE, EVEN IF ADVISED OF THE POSSIBILITY OF SUCH DAMAGE.

Progress Artix ESB for C++ v5.6 contains IBM Licensed Materials Copyright IBM Corporation 2010 (IBM 32-bit Runtime Environment for AIX, Java Technology Edition v 1.6.0 SR9 FP2).

Updated: December 5, 2011



# Contents

<b>List of Figures</b>	<b>21</b>
<b>Preface</b>	<b>23</b>
<b>Chapter 1 Basic Plug-In Implementation</b>	<b>25</b>
<b>Overview of a Basic Artix Plug-In</b>	<b>26</b>
<b>Developing an Artix Plug-In</b>	<b>30</b>
Development Steps	31
Implementing a BusPlugInFactory Class	32
Implementing a BusPlugIn Class	35
Creating Static Instances	39
<b>Chapter 2 Request Interceptors</b>	<b>41</b>
<b>Overview of Request Interceptors</b>	<b>42</b>
Client Request Interceptors	43
Server Request Interceptors	47
<b>Sending and Receiving Header Contexts</b>	<b>55</b>
SOAP Header Context Example	56
Sample Context Schema	58
Implementation of the Client Request Interceptor	60
Implementation of the Server Request Interceptor	70
Implementation of the Interceptor Factory	76
<b>Accessing and Modifying Parameters</b>	<b>85</b>
Reflection Example	86
Implementation of the Client Request Interceptor	89
Implementation of the Server Request Interceptor	94
<b>Raising Exceptions</b>	<b>99</b>
<b>Chapter 3 WSDL Extension Elements</b>	<b>103</b>
<b>WSDL Structure</b>	<b>104</b>
<b>WSDL Parse Tree</b>	<b>106</b>
<b>How to Extend WSDL</b>	<b>110</b>
<b>Extension Elements for the Stub Plug-In</b>	<b>113</b>

Implementing an Extension Element Base Class	114
Implementing the Extension Element Classes	119
Implementing the Extension Factory	125
Registering the Extension Factory	131
<b>Chapter 4 Artix Transport Plug-Ins</b>	<b>133</b>
<b>The Artix Transport Layer</b>	<b>134</b>
Architecture Overview	135
Artix Transport Classes	137
<b>Transport Threading Models</b>	<b>140</b>
Threading Introduction	141
MESSAGING_PORT_DRIVEN and MULTI_INSTANCE	143
MESSAGING_PORT_DRIVEN and MULTI_THREADED	145
MESSAGING_PORT_DRIVEN and SINGLE_THREADED	148
EXTERNALLY_DRIVEN	150
<b>Dispatch Policies</b>	<b>152</b>
Dispatch Policy Overview	153
RPC-Style Dispatch	155
Messaging-Style Dispatch	158
<b>Accessing Contexts</b>	<b>161</b>
<b>Oneway Semantics</b>	<b>165</b>
<b>Stub Transport Example</b>	<b>168</b>
Implementing the Client Transport	169
Implementing the Server Transport	176
Implementing the Transport Factory	183
Registering and Packaging the Transport	190
<b>Chapter 5 Artix Logging Reference</b>	<b>193</b>
Using Artix TRACE Macros	194
<b>Chapter 6 WS-RM Persistence</b>	<b>199</b>
<b>Introduction to WS-RM Persistence</b>	<b>200</b>
<b>WS-RM Persistence API</b>	<b>204</b>
Overview of the Persistence API	205
RMPersistentManager Class	206
RMEndpointPersistentStore Class	210
RMSequencePersistentStore Class	213
<b>Persistence and Recovery Algorithms</b>	<b>216</b>

Persistence at a Source Endpoint	217
Recovery of a Source Endpoint	219
Persistence at a Destination Endpoint	221
Recovery of a Destination Endpoint	224
<b>Implementing a WS-RM Persistence Plug-In</b>	<b>227</b>
<b>Index</b>	<b>229</b>

## CONTENTS

# List of Figures

Figure 1: Loading a Plug-In	27
Figure 2: Initializing a Plug-In	29
Figure 3: A Client Request Interceptor Chain	43
Figure 4: Server Request Interceptor Chain	47
Figure 5: Server Request Interceptors Using <code>intercept_around_dispatch()</code>	48
Figure 6: Overview of the Custom SOAP Header Demonstration	56
Figure 7: WSDL Parse Tree Inheritance Hierarchy	107
Figure 8: Factory Pattern for WSDL Extension Elements	111
Figure 9: Extension Element Classes	112
Figure 10: Artix Transport Architecture	135
Figure 11: Overview of the Artix Transport Classes	137
Figure 12: <code>MESSAGING_PORT_DRIVEN</code> and <code>MULTI_INSTANCE</code> Threading Model	143
Figure 13: <code>MESSAGING_PORT_DRIVEN</code> and <code>MULTI_THREADED</code> Threading Model	145
Figure 14: <code>MESSAGING_PORT_DRIVEN</code> and <code>SINGLE_THREADED</code> Threading Model	148
Figure 15: <code>EXTERNALLY_DRIVEN</code> Threading Model	150
Figure 16: Overview of RPC-Style Dispatch	155
Figure 17: Overview of Messaging-Style Dispatch	158
Figure 18: Overview of WS-ReliableMessaging with Persistence	200
Figure 19: Sample WS-RM Message Exchange Pattern	201
Figure 20: Overview of the WS-RM Persistence API	205
Figure 21: Overview of Persisting a Source Endpoint	217
Figure 22: Overview of Recovering a Source Endpoint	219
Figure 23: Overview of Persisting a Destination Endpoint	221
Figure 24: Overview of Recovering a Destination Endpoint	224

## LIST OF FIGURES

# Preface

## **What is Covered in This Book**

Artix is built on top of Progress ART (Adaptive Runtime Technology), which uses dynamic linking to load Artix plug-ins at runtime. This book explains how to write your own plug-ins for the ART framework. Two major areas are covered: implementing Artix interceptors, which enables you to access request and reply messages as they pass through the stack; and implementing Artix transports, which enables you to implement custom transport protocols.

## **Who Should Read This Book**

This book is aimed at experienced Artix developers who need to customize the behavior of their Artix applications using advanced APIs.

If you would like to know more about WSDL concepts, see the Introduction to WSDL in *Learning about Artix*.

## **The Artix Documentation Library**

For information on the organization of the Artix library, the document conventions used, and where to find additional resources, see [Using the Artix Library](#).

## PREFACE



# Basic Plug-In Implementation

*This chapter describes how to implement the core classes of an Artix plug-in, `IT_Bus::BusPlugInFactory` and `IT_Bus::BusPlugIn`.*

---

**In this chapter**

This chapter discusses the following topics:

<a href="#">Overview of a Basic Artix Plug-In</a>	<a href="#">page 26</a>
<a href="#">Developing an Artix Plug-In</a>	<a href="#">page 30</a>

---

# Overview of a Basic Artix Plug-In

---

## Overview

This section describes the basic features of an Artix plug-in:

- [Artix plug-ins](#).
  - [Plug-in packaging](#).
  - [Configuration](#).
  - [Loading the plug-in](#).
  - [Initializing the plug-in](#).
  - [BusPlugInFactory object](#).
  - [BusPlugIn object](#).
- 

## Artix plug-ins

An *Artix plug-in* is a well-defined component that can be independently loaded into an application. Artix defines a platform-independent framework for loading plug-ins dynamically, based on the dynamic linking capabilities of modern operating systems (that is, using shared libraries or DLLs).

---

## Plug-in packaging

Plug-ins are packaged in a form that is compatible with the dynamic linking capabilities of the particular platform on which they are deployed: a shared library, a DLL, or a JAR file.

For example, version 5 of a `tunnel` plug-in implemented in C++ for the Visual C++ 6.0 compiler on the Windows platform would be packaged as a `.dll` file and a `.dps` file (ART-specific dependencies file), as follows:

```
it_tunnel5_vc60.dll
it_tunnel5_vc60.dps
```

---

## Configuration

The plug-ins that an application should load are specified by the `orb_plugins` configuration variable, which contains a list of plug-in names.

In addition, for each plug-in that is to be loaded, you need to identify the whereabouts of the plug-in. For C++ applications, you specify the root name of the corresponding shared library using the

`plugins:<plugin_name>:shlib_name` configuration variable.

For example, the following extract shows how to configure an application, whose ORB name is `plugin_example`, to load a single plug-in, `sample_artix_interceptor`.

```
# Artix domain configuration file
...
plugin_example {
    orb_plugins = ["sample_artix_interceptor"];

    plugins:sample_artix_interceptor:shlib_name =
        "it_sample_artix_interceptor";
};
```

## Loading the plug-in

Figure 1 show how a plug-in is loaded by an application as the application starts up.

**Figure 1:** *Loading a Plug-In*

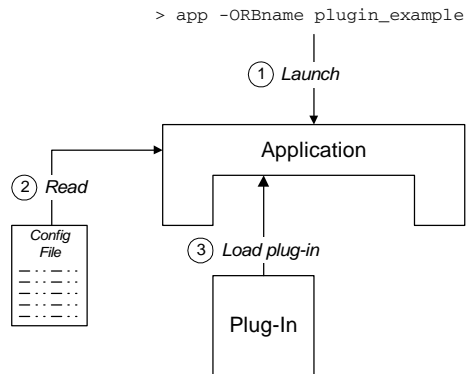

The steps to load the plug-in are as follows:

1. The user launches the application, `app`, specifying the ORB name as `plugin_example` at the command line.
2. As the application starts up, it scans the Artix configuration file to determine which plug-ins to load. Priority is given to the configuration settings in the `plugin_example` configuration scope (that is, the ORB name determines which configuration scopes to search).
3. The Artix core loads the plug-ins specified by the application's configuration.

## Initializing the plug-in

Plug-ins are usually initialized when the main application code calls `IT_Bus::init()`. [Figure 2](#) shows the plug-in initialization sequence, which proceeds as follows:

1. The main application code calls `IT_Bus::init()`.
2. The Artix core iterates over all of the plug-ins in the `orb_plugins` list, calling `IT_Bus::BusPlugInFactory::create_bus_plugin()` on each one.
3. The `BusPlugInFactory` object creates an `IT_Bus::BusPlugIn` object, which initializes the state of the plug-in for the current `Bus` instance.
4. After all of the `BusPlugIn` objects have been created, the Artix core calls `bus_init()` on each `BusPlugIn` object.

**Figure 2:** *Initializing a Plug-In*

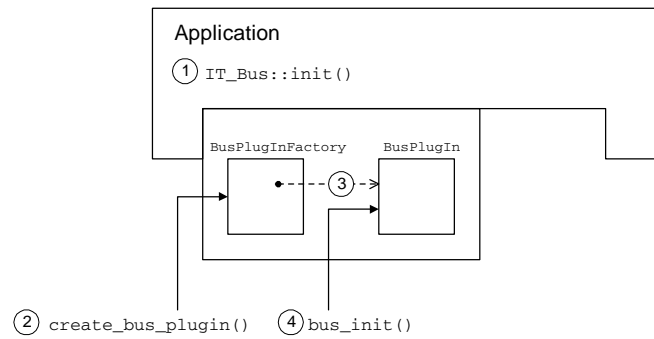

## BusPlugInFactory object

A `BusPlugInFactory` object provides the basic hook for initializing an Artix plug-in. A single static instance of the `BusPlugInFactory` object is created when the plug-in is loaded into an application. See [“Implementing a BusPlugInFactory Class” on page 32](#) for more details.

## BusPlugIn object

A `BusPlugIn` object caches the state of the plug-in for the current `Bus` instance (an application can create multiple `Bus` instances). Typically, the `BusPlugIn` object is responsible for performing most of the plug-in initialization and shutdown tasks.

---

# Developing an Artix Plug-In

---

## Overview

This section describes how to develop the basic classes for the `sample_artix_interceptor` plug-in. The objects described here, of `IT_Bus::BusPlugInFactory` and `IT_Bus::BusPlugIn` type, are the basic objects needed by every Artix plug-in, enabling a plug-in to initialize and register with the Artix core.

---

## In this section

This section contains the following subsections:

<a href="#">Development Steps</a>	<a href="#">page 31</a>
<a href="#">Implementing a BusPlugInFactory Class</a>	<a href="#">page 32</a>
<a href="#">Implementing a BusPlugIn Class</a>	<a href="#">page 35</a>
<a href="#">Creating Static Instances</a>	<a href="#">page 39</a>

---

## Development Steps

---

### How to implement

To implement an Artix plug-in, perform the following steps:

Step	Action
1	Implement a class that inherits from the <code>IT_Bus::BusPlugInFactory</code> base class. This class should: <ul style="list-style-type: none"> <li>• Implement <code>create_bus_plugin()</code> to return a new <code>IT_Bus::BusPlugIn</code> object.</li> <li>• Implement <code>destroy_bus_plugin()</code> to clean up the allocated <code>BusPlugIn</code> object at shutdown time.</li> </ul>
2	Implement a class that inherits from the <code>IT_Bus::BusPlugIn</code> base class. This class should: <ul style="list-style-type: none"> <li>• Implement <code>bus_init()</code> to perform various actions at initialization time.</li> <li>• Implement <code>bus_shutdown()</code> to perform various actions at shutdown time.</li> </ul>
3	Create the following static instances: <ul style="list-style-type: none"> <li>• A static instance of the newly implemented <code>BusPlugInFactory</code> class.</li> <li>• Either of the following static instances:               <ul style="list-style-type: none"> <li>◆ A static instance of the <code>IT_Bus::BusORBPlugIn</code> class (for plug-ins packaged as a shared library), or</li> <li>◆ A static instance of the <code>IT_Bus::GlobalBusORBPlugIn</code> class (for plug-ins linked directly to the application).</li> </ul> </li> </ul> The static instances are created when the library containing the plug-in is loaded.

---

## Implementing a BusPlugInFactory Class

---

### Overview

This section describes how to implement a `BusPlugInFactory` class for the `sample_artix_interceptor` plug-in.

An `BusPlugInFactory` object is the most fundamental constituent of a plug-in and is responsible for bootstrapping the rest of the plug-in functionality. A typical `BusPlugInFactory` implementation does not do very much. Usually it just creates a new `BusPlugIn` object in response to an invocation of the `create_bus_plugin()` operation.

---

### C++ `BusPlugInFactory` header

[Example 1](#) shows the C++ header for the `SampleBusPlugInFactory` class, which is an example of an `IT_Bus::BusPlugInFactory` class.

#### **Example 1:** *C++ Header for the `BusPlugInFactory` Class*

```
// C++
#include <it_bus/bus.h>
#include <it_bus/exception.h>
1 #include <it_bus_pdk/bus_plugin_factory.h>
// In namespace, IT_SampleArtixInterceptor
2 class SampleBusPlugInFactory :
    public IT_Bus::BusPlugInFactory
{
public:
    SampleBusPlugInFactory();
    virtual ~SampleBusPlugInFactory();

    virtual IT_Bus::BusPlugIn*
    create_bus_plugin(
        IT_Bus::Bus_ptr bus
    ) IT_THROW_DECL((IT_Bus::Exception));

    virtual void
    destroy_bus_plugin(
        IT_Bus::BusPlugIn* bus_plugin
    );

private:
    SampleBusPlugInFactory(const SampleBusPlugInFactory&);
```



**Example 1:** C++ Header for the *BusPlugInFactory* Class

```
SampleBusPlugInFactory&
operator=(const SampleBusPlugInFactory&);
};
```

The preceding header file can be described as follows:

1. Include `it_bus_pdk/bus_plugin_factory.h`, which is the header file for the `IT_Bus::BusPlugInFactory` class.
2. The plug-in factory class, `SampleBusPlugInFactory`, inherits from `IT_Bus::BusPlugInFactory`, which is the base class for all plug-in factories.

## C++ `SampleBusPlugInFactory` implementation

[Example 2](#) shows the C++ implementation of the `SampleBusPlugInFactory` class, which is an example of an `IT_Bus::BusPlugInFactory` class.

**Example 2:** C++ Implementation of the *SampleBusPlugInFactory* Class

```
// C++
// SampleBusPlugInFactory
//
SampleBusPlugInFactory::SampleBusPlugInFactory()
{
    // complete
}

SampleBusPlugInFactory::~SampleBusPlugInFactory()
{
    // complete
}

IT_Bus::BusPlugIn*
1 SampleBusPlugInFactory::create_bus_plugin(
    IT_Bus::Bus* bus
) IT_THROW_DECL((IT_Bus::Exception))
{
    return new SampleBusPlugIn(bus);
}
```

**Example 2:** *C++ Implementation of the SampleBusPlugInFactory Class*

```
2 void
  SampleBusPlugInFactory::destroy_bus_plugin(
    IT_Bus::BusPlugIn* bus_plugin
  )
  {
    delete bus_plugin;
  }
```

The preceding implementation can be described as follows:

1. The `SampleBusPlugInFactory::create_bus_plugin()` creates an instance of an `IT_Bus::BusPlugIn` object.

The `create_bus_plugin()` operation is automatically called whenever a new `Bus` instance is created (for example, whenever you call `IT_Bus::init()`). Because you are allowed to create more than one `Bus` instance, the plug-in must keep track of its state for each `Bus`—hence the need for a separate `BusPlugIn` object.

2. The `SampleBusPlugInFactory::destroy_bus_plugin()` cleans up `Bus` plug-in objects at shutdown time.

---

## Implementing a BusPlugIn Class

---

### Overview

This section describes how to implement a `BusPlugIn` class for the `sample_artix_interceptor` plug-in.

`BusPlugIn` objects are typically responsible for the following tasks:

- Registering factory objects that extend Artix functionality.
  - Coordinating the plug-in's initialization and shutdown tasks.
  - Caching the plug-in's per-Bus data and object references.
- 

### C++ BusPlugIn header

[Example 3](#) shows the C++ header for the `SampleBusPlugIn` class, which is an example of an `IT_Bus::BusPlugIn` class.

#### Example 3: C++ Header for the BusPlugIn Class

```

// C++
#include <it_bus/bus.h>
#include <it_bus/exception.h>
1 #include <it_bus_pdk/bus_plugin.h>

// In namespace IT_SampleArtixInterceptor
2 class SampleBusPlugIn :
    public IT_Bus::BusPlugIn,
    public IT_Bus::InterceptorFactory
{
public:
    // IT_Bus::BusPlugIn
    //
    IT_EXPLICIT
    SampleBusPlugIn(
        IT_Bus::Bus_ptr bus
    ) IT_THROW_DECL((IT_Bus::Exception));

    virtual ~SampleBusPlugIn();

    virtual void
    bus_init() IT_THROW_DECL((IT_Bus::Exception));

    virtual void
    bus_shutdown() IT_THROW_DECL((IT_Bus::Exception));

```

**Example 3:** C++ Header for the BusPlugIn Class

```

// IT_Bus::InterceptorFactory
//
... // (not shown)

private:
    SampleBusPlugIn(const SampleBusPlugIn&);

    SampleBusPlugIn&
    operator=(const SampleBusPlugIn&);

    IT_Bus::String m_name;
};

```

The preceding C++ header can be described as follows:

1. Include `it_bus_pdk/bus_plugin.h`, which is the header file for the `IT_Bus::BusPlugIn` class.
2. The plug-in class, `SampleBusPlugIn`, inherits from two base classes:
  - ◆ `IT_Bus::BusPlugIn`—the base class for all plug-in classes.
  - ◆ `IT_Bus::InterceptorFactory`—the base class for an interceptor factory. You only need this class, if you are implementing Artix interceptors (the code here is taken from an Artix interceptor demonstration).

**C++ BusPlugIn implementation**

**Example 4** shows the C++ implementation of the `SampleBusPlugIn` class, which is an example of an `IT_Bus::BusPlugIn` class.

**Example 4:** C++ Implementation of the BusPlugIn Class

```

// C++

// In namespace IT_SampleArtixInterceptor

1 SampleBusPlugIn::SampleBusPlugIn(
    IT_Bus::Bus_ptr bus
) IT_THROW_DECL((IT_Bus::Exception))
:
2   BusPlugIn(bus),
3   m_name("artix_interceptor")
{

```

**Example 4:** *C++ Implementation of the BusPlugIn Class*

```

        assert(bus != 0);
    }

SampleBusPlugIn::~SampleBusPlugIn()
{
    // complete
}

void
4 SampleBusPlugIn::bus_init(
) IT_THROW_DECL((IT_Bus::Exception))
{
5     IT_Bus::Bus_ptr bus = get_bus();

    InterceptorFactoryManager& factory_manager =
        bus->get_pdk_bus()->get_interceptor_factory_manager();

6     factory_manager.register_interceptor_factory(
        m_name,
        this
    );
}

void
7 SampleBusPlugIn::bus_shutdown(
) IT_THROW_DECL((IT_Bus::Exception))
{
    IT_Bus::Bus_ptr bus = get_bus();
    assert(bus != 0);

    InterceptorFactoryManager& factory_manager =
        bus->get_pdk_bus()->get_interceptor_factory_manager();

8     factory_manager.unregister_interceptor_factory(
        this
    );
}

```

The preceding C++ implementation can be described as follows:

1. The `BusPlugIn` constructor typically does not do much, apart from initializing a couple of member variables.
2. You must always pass the `bus` instance to the base constructor, `IT_Bus::BusPlugIn()`, which caches the reference and makes it available through the `IT_Bus::BusPlugIn::get_bus()` accessor.
3. The `m_name` member variable caches the name of the interceptor factory for later use. The interceptor name is used in the following contexts:
  - ◆ When registering the interceptor factory with the bus.
  - ◆ To enable the interceptor, by adding the interceptor name to the relevant lists of interceptors in the `artix.cfg` file.
4. Artix calls `bus_init()` after all of the plug-ins have been created by calls to `create_bus_plugin()`. The `bus_init()` function is where most of the plug-in initialization actually occurs. Typical tasks performed in `bus_init()` include:
  - ◆ Reading configuration information from the `artix.cfg` configuration file.
  - ◆ Registering special kinds of objects, such as interceptor factories, transport factories, binding factories, and so on.
  - ◆ Logging.
5. The `BusPlugIn::get_bus()` function accesses the `Bus` reference that was cached by the `BusPlugIn` base class constructor.
6. Because this code is from an interceptor demonstration, the `bus_init()` implementation registers an interceptor factory. The `register` function takes the interceptor name, `m_name`, and the interceptor factory instance, `this`, as arguments.
7. Artix calls `bus_shutdown()` as the `Bus` is being shut down. This is a the place to clean up any resources used by the plug-in implementation. Typically, you would also unregister objects that were registered in `bus_init()`.
8. Because this code is from an interceptor demonstration, unregister the interceptor factory.

---

## Creating Static Instances

---

### Overview

The mechanism for bootstrapping a plug-in is based on declaring two static objects, as follows:

- A static instance of the plug-in factory (a subtype of `IT_Bus::BusPlugInFactory`).
  - Either of the following static instances:
    - ◆ [BusORBPlugIn static instance](#).
    - ◆ [GlobalBusORBPlugIn static instance](#).
- 

### BusORBPlugIn static instance

Create a static instance of `IT_Bus::BusORBPlugIn` type, if you intend to package your plug-in as a shared library. The `BusORBPlugIn` constructor has the following characteristics:

- The constructor registers the Bus plug-in factory with the Bus core.
- The constructor does *not* call `create_bus_plugin()` on the factory.

If a plug-in is packaged as a shared library, you must list the plug-in name in the `orb_plugins` list in the Artix configuration file. For each of the plug-ins listed in `orb_plugins`, Artix does the following:

- Artix attempts to load the relevant shared library (dynamic loading).
  - Artix calls `create_bus_plugin()` on the factory.
- 

### GlobalBusORBPlugIn static instance

Create a static instance of `IT_Bus::GlobalBusORBPlugIn` type, if you intend to link the plug-in code directly into your application. The `GlobalBusORBPlugIn` constructor has the following characteristics:

- The constructor registers the Bus plug-in factory with the Bus core.
- The constructor calls `create_bus_plugin()` on the factory.

A side effect of using `GlobalBusORBPlugIn` is that you can have only one `IT_Bus::BusPlugIn` object for each application (instead of one `IT_Bus::BusPlugIn` object for each Bus object).

If a plug-in is linked directly with your application, there is no need to add the plug-in name to the `orb_plugins` list in the Artix configuration.

**C++ static instances**

Static instances, of `SampleBusPlugInFactory` and `IT_Bus::BusORBPlugIn` type, are created by the following lines of code.

**Example 5:** *Creating Static Objects for a Plug-In*

```
// C++
namespace IT_SampleArtixInterceptor
{
1   const char* const und_sample_plugin_name =
   "sample_artix_interceptor";
2
   SampleBusPlugInFactory und_sample_plugin_factory;
3
   IT_Bus::BusORBPlugIn und_sample_interceptor_plugin(
       und_sample_plugin_name,
       und_sample_plugin_factory
   );
}
```

The preceding code can be explained as follows:

1. Define the plug-in name to be `sample_artix_interceptor`. This is the name that must be added to the `orb_plugins` list in the `artix.cfg` file in order to load the plug-in.
2. Create a static `SampleBusPlugInFactory` instance, `und_sample_plugin_factory`. This static instance is created automatically, as soon as the `sample_artix_interceptor` plug-in is loaded.
3. Create a static `IT_Bus::BusORBPlugIn` instance, `und_sample_interceptor_plugin`, taking the plug-in name, `und_sample_plugin_name`, and the plug-in factory, `und_sample_plugin_factory`, as arguments.

This line is of critical importance because it bootstraps the entire plug-in functionality. When the static `BusORBPlugIn` constructor is called, it automatically registers the plug-in factory with the Bus.



# Request Interceptors

*Artix request interceptors enable you to intercept operation requests and replies, where the request and reply data are accessible in a high-level format. This chapter describes how to access and modify header data and parameter data from within a request interceptor.*

---

**In this chapter**

This chapter discusses the following topics:

<a href="#">Overview of Request Interceptors</a>	<a href="#">page 42</a>
<a href="#">Sending and Receiving Header Contexts</a>	<a href="#">page 55</a>
<a href="#">Accessing and Modifying Parameters</a>	<a href="#">page 82</a>
<a href="#">Raising Exceptions</a>	<a href="#">page 96</a>

---

# Overview of Request Interceptors

---

**Overview**

This section provides a high-level overview of the architecture of request interceptors in Artix.

---

**In this section**

This section contains the following subsections:

<a href="#">Client Request Interceptors</a>	<a href="#">page 43</a>
<a href="#">Server Request Interceptors</a>	<a href="#">page 47</a>

---

## Client Request Interceptors

---

### Overview

Client request interceptors are used to intercept requests (and replies) on the client side, between the proxy object and the binding. [Figure 3](#) shows the architecture of a client request interceptor chain.

**Figure 3:** *A Client Request Interceptor Chain*

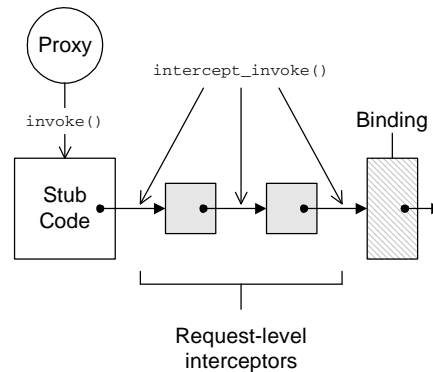

### Interceptor chaining

A client request interceptor chain is arranged as a singly-linked list: each interceptor in the chain stores a pointer to the next and the chain is terminated by a binding object.

Client request interceptor chains are created dynamically. The Artix core reads the relevant configuration variables as it starts up and initializes a chain of interceptors that link together in the specified order.

### ClientRequestInterceptor class

A client request interceptor is represented by an instance of `IT_Bus::ClientRequestInterceptor` type. The `ClientRequestInterceptor` class has the following members:

- `m_next_interceptor` member variable.  
Stores the pointer to the next `ClientRequestInterceptor` in the chain. The `m_next_interceptor` variable is automatically initialized by Artix when it constructs the chain.

- `intercept_invoke()` member function.

This is the main interceptor function. You implement this function to implement new features with interceptors.

## `intercept_invoke()` function

**Example 6** shows the basic outline of how to implement the `intercept_invoke()` function.

### **Example 6:** *Outline of `intercept_invoke()` Function*

```
// C++
using namespace IT_Bus;

void
CustomClReqInterceptor::intercept_invoke(ClientOperation& data)
{
    // PRE-INVOKE processing
    // ...

    m_next_interceptor->intercept_invoke(data);

    // POST-INVOKE processing
    // ...
}
```

The typical implementation of `intercept_invoke()` has three main parts:

- *Pre-invoke processing*—put any code here that you would want to execute *before* the request is dispatched to the remote server. At this point, the input parts are already initialized. You can examine or replace input parts.
- *Call the next interceptor in the chain*—you must always call `intercept_invoke()` on the next interceptor, as shown here.
- *Post-invoke processing*—put any code here that you would want to execute *after* the reply is received from the remote server. At this point, both the input and output parts are initialized. You can examine or modify the output parts. Replacing parts has no effect.

## ClientOperation class

The data object that passes along the client request interceptor chain is an instance of the `IT_Bus::ClientOperation` class. The `ClientOperation` class encapsulates all of the request and reply data.

The most important member functions of the `ClientOperation` class are as follows:

- `get_name()`  
Returns an `IT_Bus::String` that holds the name of the operation that is being invoked.
- `get_input_message()`  
Returns an `IT_Bus::WritableMessage` object that contains the input parts. The simplest way to obtain the input parts list is to call `get_input_message().get_parts()`.
- `get_output_message()`  
Returns an `IT_Bus::ReadableMessage` object that contains the output parts. The simplest way to obtain the output parts list is to call `get_output_message().get_parts()`.
- `request_contexts()`  
Returns an `IT_Bus::ContextContainer` object that provides access to request contexts. You can use this object to write or read headers in the request message.
- `reply_contexts()`  
Returns an `IT_Bus::ContextContainer` object that provides access to reply contexts. You can use this object to write or read headers in the reply message.

## Configuring a client request interceptor

To configure Artix to use a client request interceptor, you must update the client request interceptor list in the Artix configuration file. The client request interceptor list consists of a list of alternative chain configurations, as follows:

```
binding:artix:client_request_interceptor_list = ["Chain01",  
"Chain02", "Chain03", ...];
```

The Artix core first attempts to construct an interceptor chain according to pattern in `Chain01`. If this attempt fails (for example, if one of the interceptors in the chain is unavailable) Artix attempts to use the next chain configuration, `Chain02`, instead.

Each chain configuration is specified in the following format:

```
" InterceptorA+InterceptorB+ . . . "
```

Where *InterceptorA* is the name of interceptor A and *InterceptorB* is the name of interceptor B and so on. An *interceptor name* is the name under which the interceptor factory is registered with the

```
IT_Bus::InterceptorFactoryManager.
```

---

### Configuring an interceptor in an Artix router

If an interceptor is meant to be used within an Artix router process, you might need to configure the router to ensure the interceptor is not bypassed. Specifically, if you configure a route that maps messages between two bindings of the same type (for example, CORBA-to-CORBA), the router bypasses interceptors by default. This is often a useful optimization, but is unsuitable for some applications.

To force all routed messages to pass through the interceptors in the router, you should add the following line to the router's configuration:

```
plugins:routing:use_pass_through = "false";
```

## Server Request Interceptors

### Overview

Server request interceptors are used to intercept requests (and replies) on the server side, between the binding and the servant object. [Figure 4](#) shows the architecture of a server request interceptor chain.

**Figure 4:** *Server Request Interceptor Chain*

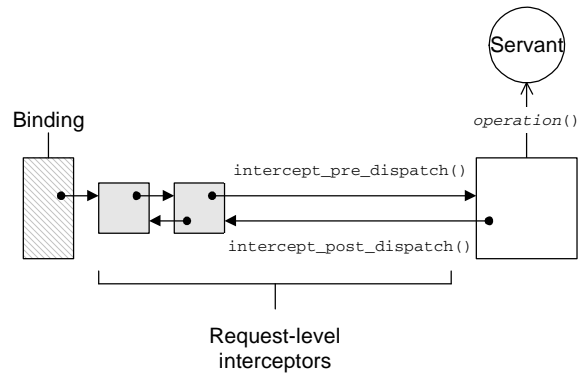

### Interceptor chaining

A server request interceptor chain is arranged as a doubly-linked list: each interceptor in the chain stores pointers to the next one and the previous one.

Server request interceptor chains are created dynamically. The Artix core reads the relevant configuration variables as it starts up and initializes a chain of interceptors that link together in the specified order.

**Alternative interceptor model**

Server request interceptors support an alternative interceptor model, which requires you to implement a single interceptor function, `intercept_around_dispatch()`, as shown in [Figure 5](#).

**Figure 5:** *Server Request Interceptors Using `intercept_around_dispatch()`*

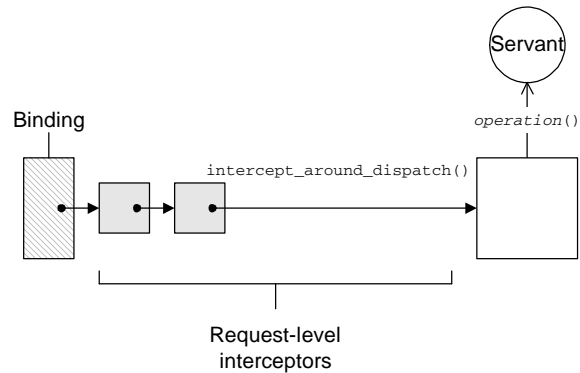

The `intercept_around_dispatch()` is called at the very start of the dispatch process (before `intercept_pre_dispatch()`) and returns at the very end of the dispatch process (after `interceptor_post_dispatch()`).

**ServerRequestInterceptor class**

A server request interceptor is represented by an instance of `IT_Bus::ServerRequestInterceptor` type. The `ServerRequestInterceptor` class has the following members:

- `m_next_interceptor` member variable.  
Stores the pointer to the next `ServerRequestInterceptor` in the chain. The `m_next_interceptor` variable is automatically initialized by Artix.
- `m_prev_interceptor` member variable.  
Stores the pointer to the preceding `ServerRequestInterceptor` in the chain. The `m_prev_interceptor` variable is automatically initialized by Artix.
- `intercept_around_dispatch()` member function.



An intercept point that is called at the very start of the dispatch process (before the input parts have been unmarshalled); and returns at the very end of the dispatch process (after the output parts have been marshalled).

If you don't want to implement this function, you can inherit the default implementation from `IT_Bus::ServerRequestInterceptor`, which simply calls the next interceptor in the chain.

- `intercept_pre_dispatch()` member function.

Called after the input parts have been unmarshalled, but before dispatching to the servant.

If you don't want to implement this function, you can inherit the default implementation from `IT_Bus::ServerRequestInterceptor`, which simply calls the next interceptor in the chain.

- `intercept_post_dispatch()` member function.

Called after dispatching to the servant, but before marshalling the output parts.

If you don't want to implement this function, you can inherit the default implementation from `IT_Bus::ServerRequestInterceptor`, which simply calls the next interceptor in the chain.

---

### Combining the interceptor models

If necessary, you can combine the two interceptor models by implementing all of the intercept functions from the `ServerRequestInterceptor` class. In this case, the sequence of interceptor calls is as follows:

1. Artix calls `intercept_around_dispatch()` on the first interceptor, which calls `intercept_around_dispatch()` on the second interceptor, and so on to the end of the chain.
2. Inside the call to `intercept_around_dispatch()`, Artix calls the first interceptor's `intercept_pre_dispatch()` function, which calls the second interceptor's `intercept_pre_dispatch()` function, and so on to the end of the chain. The last interceptor returns, then the next-to-last interceptor, and then all the way back to the first interceptor.
3. Artix calls the application code.
4. Artix calls the last interceptor's `intercept_post_dispatch()` function, which calls the next-to-last interceptor's `intercept_post_dispatch()` function and so on. The first interceptor returns all the way back to the last.

5. The last interceptor's call to `intercept_around_dispatch()` returns, all the way back to the first interceptor.

### Sample call sequence

To illustrate the sequence of calls that results when the intercept functions are all used together, consider the chain of three interceptors, A, B, and C, where A is the first interceptor in the chain, and C is the last. [Example 7](#) shows the sequence of events, where `>>` denotes entering a function and `<<` denotes leaving a function.

#### Example 7: *Sample Server Interceptor Call Sequence*

```
A >> interceptor_around_dispatch()
B >> interceptor_around_dispatch()
C >> interceptor_around_dispatch()
  A >> interceptor_pre_dispatch()
    B >> interceptor_pre_dispatch()
      C >> interceptor_pre_dispatch()
        C << interceptor_pre_dispatch()
      B << interceptor_pre_dispatch()
    A << interceptor_pre_dispatch()
  Application >> invoke()
  Application << invoke()
  C >> interceptor_post_dispatch()
    B >> interceptor_post_dispatch()
      A >> interceptor_post_dispatch()
        A << interceptor_post_dispatch()
      B << interceptor_post_dispatch()
    C << interceptor_post_dispatch()
  C << interceptor_around_dispatch()
B << interceptor_around_dispatch()
A << interceptor_around_dispatch()
```

### `intercept_around_dispatch()` function

[Example 8](#) shows the basic outline of how to implement the `intercept_around_dispatch()` function.

#### Example 8: *Outline of `intercept_around_dispatch()` Function*

```
// C++
using namespace IT_Bus;

void
CustomSrvrReqInterceptor::intercept_around_dispatch(
    ServerOperation& data
)
```

**Example 8:** *Outline of intercept\_around\_dispatch() Function*

```

{
    // PRE-UNMARSHAL processing
    // ...

    if (m_next_interceptor != 0) {
        m_next_interceptor->intercept_around_dispatch(data);
    }

    // POST-MARSHAL processing
    // ...
}

```

The typical implementation of `intercept_around_dispatch()` has three main parts:

- *Pre-unmarshal processing*—put any code here that you would want to execute *before* the request is dispatched to the servant object. At this point, the input parts are not yet unmarshalled. Therefore, you cannot access the input parts.
- *Call the next interceptor in the chain*—you must always call `intercept_around_dispatch()` on the next interceptor, as shown here.
- *Post-marshal processing*—put any code here that you would want to execute *after* the servant code has executed. At this point, both the input and output parts are available. You can examine or modify the output parts. Replacing parts has no effect.

**intercept\_pre\_dispatch() function**

[Example 9](#) shows the basic outline of how to implement the `intercept_pre_dispatch()` function.

**Example 9:** *Outline of intercept\_pre\_dispatch() Function*

```

// C++
using namespace IT_Bus;

void
CustomSrvrReqInterceptor::intercept_pre_dispatch(
    ServerOperation& data
)
{
    // PRE-DISPATCH processing
    // ...
}

```

**Example 9:** *Outline of intercept\_pre\_dispatch() Function*

```

if (m_next_interceptor != 0) {
    m_next_interceptor->intercept_pre_dispatch(data);
}
}

```

The typical implementation of `intercept_pre_dispatch()` has two main parts:

- *Pre-dispatch processing*—put any code here that you would want to execute *before* the request is dispatched to the servant object. At this point, the input parts are unmarshalled. You can access or modify (but not replace) the input parts.
- *Call the next interceptor in the chain*—you must always call `intercept_pre_dispatch()` on the next interceptor, as shown here.

**intercept\_post\_dispatch()  
function**

**Example 10** shows the basic outline of how to implement the `intercept_post_dispatch()` function.

**Example 10:** *Outline of intercept\_post\_dispatch() Function*

```

// C++
using namespace IT_Bus;

void
CustomSrvrReqInterceptor::intercept_post_dispatch(
    ServerOperation& data
)
{
    // POST-DISPATCH processing
    // ...

    if (m_prev_interceptor != 0) {
        m_prev_interceptor->intercept_post_dispatch(data);
    }
}

```

The typical implementation of `intercept_post_dispatch()` has two main parts:

- *Post-dispatch processing*—put any code here that you would want to execute *after* the request is dispatched to the servant object. At this point, the output parts are initialized. You can access or replace the output parts.

- *Call the previous interceptor in the chain*—you must always call `intercept_post_dispatch()` on the previous interceptor, as shown here.

## ServerOperation class

The data object that passes along the server request interceptor chain is an instance of the `IT_Bus::ServerOperation` class. The `ServerOperation` class encapsulates the request and reply data.

The most important member functions of the `ServerOperation` class are as follows:

- `get_name()`  
Returns an `IT_Bus::String` that holds the name of the operation that is being dispatched.
- `get_input_message()`  
Returns an `IT_Bus::ReadableMessage` object that contains the input parts. The simplest way to obtain the input parts list is to call `get_input_message().get_parts()`.
- `get_output_message()`  
Returns an `IT_Bus::WritableMessage` object that contains the output parts. The simplest way to obtain the output parts list is to call `get_output_message().get_parts()`.
- `request_contexts()`  
Returns an `IT_Bus::ContextContainer` object that provides access to request contexts. You can use this object to write or read headers in the request message.
- `reply_contexts()`  
Returns an `IT_Bus::ContextContainer` object that provides access to reply contexts. You can use this object to write or read headers in the reply message.

## Configuring a server request interceptor

To configure Artix to use a server request interceptor, you must update the server request interceptor list in the Artix configuration file. The server request interceptor list consists of a list of alternative chain configurations, as follows:

```
binding:artix:server_request_interceptor_list = ["Chain01",
"Chain02", "Chain03", ...];
```

The Artix core first attempts to construct an interceptor chain according to pattern in *Chain01*. If this attempt fails (for example, if one of the interceptors in the chain is unavailable) Artix attempts to use the next chain configuration, *Chain02*, instead.

Each chain configuration is specified in the following format:

```
"InterceptorA+InterceptorB+..."
```

Where *InterceptorA* is the name of interceptor A and *InterceptorB* is the name of interceptor B and so on. An interceptor name is the name under which the interceptor factory is registered with the

```
IT_Bus : : InterceptorFactoryManager.
```

---

### Configuring an interceptor in an Artix router

If an interceptor is meant to be used within an Artix router process, you might need to configure the router to ensure the interceptor is not bypassed. Specifically, if you configure a route that maps messages between two bindings of the same type (for example, CORBA-to-CORBA), the router bypasses interceptors by default. This is often a useful optimization, but is unsuitable for some applications.

To force all routed messages to pass through the interceptors in the router, you should add the following line to the router's configuration:

```
plugins:routing:use_pass_through = "false";
```

---

# Sending and Receiving Header Contexts

---

## Overview

You can use Artix interceptors to send and receive header contexts to transmit with operation request and replies. While it is also possible to program header contexts at the application level, there are significant advantages to writing this code at the interceptor level. Header contexts are typically used to send security credentials and other out-of-band data that are not specific to any port type. By putting this common code into an interceptor, you can avoid cluttering your servant code and client code.

---

## In this section

This section contains the following subsections:

<a href="#">SOAP Header Context Example</a>	<a href="#">page 56</a>
<a href="#">Sample Context Schema</a>	<a href="#">page 58</a>
<a href="#">Implementation of the Client Request Interceptor</a>	<a href="#">page 60</a>
<a href="#">Implementation of the Server Request Interceptor</a>	<a href="#">page 67</a>
<a href="#">Implementation of the Interceptor Factory</a>	<a href="#">page 73</a>

## SOAP Header Context Example

### Overview

The examples in this section are based on the shared library demonstration, which is located in the following Artix directory:

`ArtixInstallDir/samples/advanced/shared_library`

Figure 6 shows an overview of the shared library demonstration, showing how the client piggybacks context data along with an invocation request that is invoked on the `sayHi` operation.

**Figure 6:** *Overview of the Custom SOAP Header Demonstration*

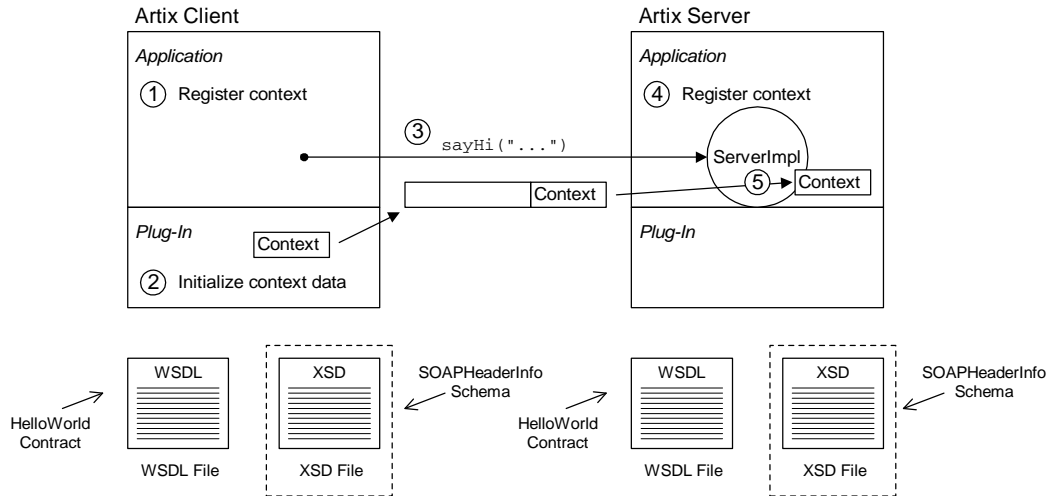



---

**Transmission of context data**

As illustrated in [Figure 6](#), SOAP context data is transmitted as follows:

1. The client registers the context type, `SOAPHeaderInfo`, with the Bus.
  2. The client interceptor initializes the context data instance.
  3. The client invokes the `sayHi ()` operation on the server.
  4. As the server starts up, it registers the `SOAPHeaderInfo` context type with the Bus.
  5. When the `sayHi ()` operation request arrives on the server side, the `sayHi ()` operation implementation extracts the context data from the request.
- 

**HelloWorld WSDL contract**

The HelloWorld WSDL contract defines the contract implemented by the server in this demonstration. In particular, the HelloWorld contract defines the `Greeter` port type containing the `sayHi` WSDL operation.

---

**SOAPHeaderInfo schema**

The `SOAPHeaderInfo` schema (in the `samples/advanced/shared_library/etc/contextTypes.xsd` file) defines the custom data type used as the context data type. This schema is specific to the shared library demonstration.

---

## Sample Context Schema

---

### Overview

This subsection describes how to define an XML schema for a context type. In this example, the `SOAPHeaderInfo` type is declared in an XML schema. The `SOAPHeaderInfo` type is then used by the shared library demonstration to send custom data in a SOAP header.

---

### SOAPHeaderInfo XML declaration

[Example 11](#) shows the schema for the `SOAPHeaderInfo` type, which is defined specifically for the shared library demonstration to carry some sample data in a SOAP header. Note that [Example 11](#) is a pure schema declaration, *not* a WSDL declaration.

#### Example 11: XML Schema for the SOAPHeaderInfo Context Type

```
<?xml version="1.0" encoding="UTF-8"?>
<xs:schema
  xmlns:xs="http://www.w3.org/2001/XMLSchema"
  targetNamespace="http://schemas.ionas.com/types/context"
  elementFormDefault="qualified"
  attributeFormDefault="unqualified">
  <xs:complexType name="SOAPHeaderInfo">
    <xs:annotation>
      <xs:documentation>
        Content to be added to a SOAP header
      </xs:documentation>
    </xs:annotation>
    <xs:sequence>
      <xs:element name="originator" type="xs:string"/>
      <xs:element name="message" type="xs:string"/>
    </xs:sequence>
  </xs:complexType>
</xs:schema>
```

The `SOAPHeaderInfo` complex type defines two member elements, as follows:

- `originator`—holds an arbitrary client identifier.
  - `message`—holds an arbitrary example message.
- 

### Target namespace

You can use any target namespace for a context schema (as long as it does not clash with an existing namespace). This demonstration uses the following target namespace:

`http://schemas.iona.com/types/context`

---

### Compiling the SOAPHeaderInfo schema

To compile the `SOAPHeaderInfo` schema, invoke the `wsdltocpp` compiler utility at the command line, as follows:

```
wsdltocpp -n custom_interceptor contextTypes.xsd
```

Where `contextTypes.xsd` is a file containing the XML schema from [Example 11](#). This command generates the following C++ stub files:

```
contextTypes_xsdTypes.h
contextTypes_xsdTypesFactory.h
contextTypes_xsdTypes.cxx
contextTypes_xsdTypesFactory.cxx
```

---

### SOAPHeaderInfo C++ mapping

[Example 12](#) shows how the schema from [Example 11 on page 58](#) maps to C++, to give the `custom_interceptor::SOAPHeaderInfo` C++ class.

#### Example 12: C++ Mapping of the SOAPHeaderInfo Context Type

```
// C++
...
namespace custom_interceptor
{
    ...
    class SOAPHeaderInfo : public IT_Bus::SequenceComplexType
    {
    public:
        static const IT_Bus::QName type_name;

        SOAPHeaderInfo();
        SOAPHeaderInfo(const SOAPHeaderInfo & copy);
        virtual ~SOAPHeaderInfo();
        ...
        IT_Bus::String & getoriginator();
        const IT_Bus::String & getoriginator() const;
        void setoriginator(const IT_Bus::String & val);

        IT_Bus::String & getmessage();
        const IT_Bus::String & getmessage() const;
        void setmessage(const IT_Bus::String & val);
        ...
    };
    ...
}
```

---

## Implementation of the Client Request Interceptor

---

### Overview

A client request interceptor performs processing on the client operation object which passes through the client interceptor chain. You implement the `intercept_invoke()` operation (called by the preceding interceptor in the chain) to perform request processing.

### The `ClientRequestInterceptor` base class

**Example 13** shows the declarations of the `IT_Bus::Interceptor` class and the `IT_Bus::ClientRequestInterceptor` class, which is the base class for a client request interceptor. The member functions that must be implemented by derived classes are highlighted in bold font.

#### **Example 13:** *The `IT_Bus::ClientRequestInterceptor` Class*

```
// C++
// In file: it_bus_pdk/interceptor.h
...
namespace IT_Bus {
    enum InterceptorType
    {
        CPP_INTERCEPTOR,
        JAVA_INTERCEPTOR
    };

1 class IT_BUS_API Interceptor
    {
    public:
        Interceptor();
        Interceptor(InterceptorFactory* factory);
        virtual ~Interceptor();

        virtual InterceptorFactory* get_factory();
        virtual InterceptorType get_type();

    private:
        InterceptorFactory* m_factory;
    };
```

**Example 13:** *The IT\_Bus::ClientRequestInterceptor Class*

```

2 class IT_BUS_API ClientRequestInterceptor
  : public Interceptor
  {
  public:
    ClientRequestInterceptor();
    ClientRequestInterceptor(InterceptorFactory* factory);
    virtual ~ClientRequestInterceptor();

    virtual void
    chain_assembled(ClientRequestInterceptorChain& chain);

    virtual void
    chain_finalized(
        ClientRequestInterceptor* next_interceptor
    );

    virtual void
    intercept_invoke(ClientOperation& data);

  protected:
    ClientRequestInterceptor* m_next_interceptor;
  };
};

```

The preceding code can be explained as follows:

1. The `IT_Bus::Interceptor` class is the common base class for all interceptor types.
2. The `IT_Bus::ClientRequestInterceptor` class, which inherits from `IT_Bus::Interceptor`, is the base class for client request interceptors.

### C++ client request interceptor header

**Example 14** shows the declaration of the

`IT_SampleArtixInterceptor::ClientInterceptor` class, which is derived from the `IT_Bus::ClientRequestInterceptor` class.

**Example 14:** *Sample Client Request Interceptor Header File*

```

// C++
// In file: samples/advanced/shared_library/
//                                     cxx/plugin/client_interceptor.h

#include <it_bus/qname.h>
#include <it_bus/bus.h>

```

**Example 14:** *Sample Client Request Interceptor Header File*

```

#include <it_bus_pdk/interceptor.h>
#include <it_cal/cal.h>

namespace IT_SampleArtixInterceptor
{
1   class ClientInterceptor :
      public virtual IT_Bus::ClientRequestInterceptor
      {
      public:
          ClientInterceptor(
              IT_Bus::Bus_ptr    bus
          );

          virtual ~ClientInterceptor();

          virtual void
          intercept_invoke(IT_Bus::ClientOperation& data);

      private:
          ClientInterceptor&
          operator = (const ClientInterceptor& rhs);

          ClientInterceptor(const ClientInterceptor& rhs);

2         IT_Bus::Bus_ptr m_bus;
      };
};

```

The preceding code can be explained as follows:

1. The `ClientInterceptor` implementation class inherits from the `IT_Bus::ClientRequestInterceptor` base class.
2. The `m_bus` member variable stores a reference to the Bus object.

### C++ client request interceptor implementation

**Example 15** shows the implementation of the `IT_SampleArtixInterceptor::ClientInterceptor` class.

**Example 15:** *Sample Client Request Interceptor Implementation*

```

// C++
// In file: samples/advanced/shared_library/
//                                     cxx/plugin/client_interceptor.cxx

```

**Example 15:** *Sample Client Request Interceptor Implementation*

```

// Include header files related to the soap context
#include <it_bus/operation.h>
#include <it_bus_pdk/context.h>

// Include header files representing the soap header content
#include "../types/contextTypes_xsdTypes.h"
#include "../types/contextTypes_xsdTypesFactory.h"

#include "client_interceptor.h"

IT_USING_NAMESPACE_STD
using namespace custom_interceptor;

using namespace IT_Bus;
using namespace IT_WSDL;
using namespace IT_SampleArtixInterceptor;

1 ClientInterceptor::ClientInterceptor(
    Bus_ptr    bus
)
    : m_bus(bus)
{
}

ClientInterceptor::~ClientInterceptor() {}

void
2 ClientInterceptor::intercept_invoke(ClientOperation& data)
{
    cout << "\tClient interceptor intercept_invoke method"
         << "\tOperation called: " << data.get_name()
         << endl;

3     // -----> PRE-INVOKE processing comes here <-----
4     // For the sayHi operation, change the originator and message
    if (data.get_name() == "sayHi")
    {
        // Obtain a pointer to the bus
        Bus_var bus = Bus::create_reference();

        // Use the bus to obtain a pointer to the ContextRegistry
        // created by the soap plugin
        ContextRegistry* context_registry =
            bus->get_context_registry();

```

**Example 15:** *Sample Client Request Interceptor Implementation*

```

// Create QName objects needed to define a context
const QName principal_ctx_name(
    "",
    "SOAPHeaderInfo",
    ""
);

// Obtain a pointer to the RequestContextContainer
5 ContextContainer* context_container =
    data.request_contexts();

// Obtain a reference to the context
6 AnyType* info = context_container->get_context(
    principal_ctx_name,
    true
);

if (0 == info)
{
    throw Exception("Could not access Context");
}

// Cast the context into a SOAPHeaderInfo object
7 SOAPHeaderInfo* header_info =
    dynamic_cast<SOAPHeaderInfo*>(info);

if (0 == header_info)
{
    throw Exception("Could not cast Context");
}

// Create the content to be added to the header
const String originator("Artix Engineering");
const String message("We are Great!");

// Add the header content
cout << "\tSetting SOAP header with originator: "
    << originator << " and message: " << message << endl;
8 header_info->setoriginator(originator);
header_info->setmessage(message);
}

if (ClientRequestInterceptor::m_next_interceptor != 0)
{

```



**Example 15:** *Sample Client Request Interceptor Implementation*

```

9      ClientRequestInterceptor::m_next_interceptor->intercept_invoke(data);
      }
10     // -----> POST-INVOKE processing comes here <-----
      }

```

The preceding code can be explained as follows:

1. The `ClientInterceptor` constructor is called by the interceptor factory at the time the interceptor chain is constructed (see [“Implementation of the Interceptor Factory” on page 73](#)). Here you should initialize a local reference to the Bus, `m_bus`, and the interceptor name, `m_name`.
2. The `intercept_invoke()` function is the key function in the client request interceptor. This is the point at which you can intercept and affect an operation invocation.
3. At this point (prior to invoking `intercept_invoke()` on the next interceptor), you can add in any processing that needs to complete *before* invoking the WSDL operation.
4. The interceptor modifies the context only for the `sayHi` operation from the `Greeter` port type.
5. The interceptor obtains a reference to the context container for outgoing requests.
6. Get a pointer to the context identified by the `SOAPHeaderInfo` QName. If an instance of this context does not already exist, the `get_context()` function creates a new one (indicated by setting the second parameter to true).
7. Cast the `IT_Bus::AnyType*` variable from the previous step, `info`, to the `SOAPHeaderInfo*` variable, `header_info`.
8. Set the originator and message attributes on the `SOAPHeaderInfo` instance, `header_info`.
9. Invoke `intercept_invoke()` on the next interceptor in the chain. This step is mandatory for almost all interceptors (a possible exception being a security interceptor that decides to prevent an invocation from proceeding).

10. At this point (after invoking `intercept_invoke()` on the next interceptor), you can add in any processing that needs to occur *after* invoking the WSDL operation.

---

## Implementation of the Server Request Interceptor

---

### Overview

A server request interceptor performs processing on the server operation object which passes through the server interceptor chain. You must implement the following functions to intercept incoming requests:

- `intercept_pre_dispatch()`
  - `intercept_post_dispatch()`
- 

### The `ServerRequestInterceptor` base class

[Example 16](#) shows the declarations of the `IT_Bus::Interceptor` class and the `IT_Bus::ServerRequestInterceptor` class, which is the base class for a server request interceptor. The member functions that must be implemented by derived classes are highlighted in bold font.

#### Example 16: *The `IT_Bus::ServerRequestInterceptor` Class*

```

// C++
// In file: it_bus_pdk/interceptor.h
...
namespace IT_Bus {
    enum InterceptorType
    {
        CPP_INTERCEPTOR,
        JAVA_INTERCEPTOR
    };

1  class IT_BUS_API Interceptor
    {
    public:
        Interceptor();
        Interceptor(InterceptorFactory* factory);
        virtual ~Interceptor();

        virtual InterceptorFactory* get_factory();
        virtual InterceptorType get_type();

    private:
        InterceptorFactory* m_factory;
    };

2  class IT_BUS_API ServerRequestInterceptor
    : public Interceptor

```

**Example 16:** *The IT\_Bus::ServerRequestInterceptor Class*

```

{
public:
    ServerRequestInterceptor();
    ServerRequestInterceptor(InterceptorFactory* factory);
    virtual ~ServerRequestInterceptor();

    virtual void
    chain_assembled(ServerRequestInterceptorChain& chain);

    virtual void
    chain_finalized(
        ServerRequestInterceptor* next_interceptor
    );

    virtual void
    intercept_pre_dispatch(ServerOperation& data);

    virtual void
    intercept_post_dispatch(ServerOperation& data);

    virtual void
    intercept_around_dispatch(ServerOperation& data);

protected:
    ServerRequestInterceptor* m_next_interceptor;
    ServerRequestInterceptor* m_prev_interceptor;
};

```

The preceding code can be explained as follows:

1. The `IT_Bus::Interceptor` class is the common base class for all interceptor types.
2. The `IT_Bus::ServerRequestInterceptor` class, which inherits from `IT_Bus::Interceptor`, is the base class for server request interceptors.
3. The server request interceptor stores references both to the next interceptor and the previous interceptor in the chain. A server request interceptor chain is thus a doubly linked list.

**C++ server request interceptor header**

**Example 17** shows the declaration of the `IT_SampleArtixInterceptor::ServerInterceptor` class, which is derived from the `IT_Bus::ServerRequestInterceptor` class.

**Example 17: Sample Server Request Interceptor Header File**

```

// C++
// In file: samples/advanced/shared_library/
//                                     cxx/plugin/server_interceptor.h

#include <it_bus/qname.h>
#include <it_bus/bus.h>
#include <it_bus_pdk/interceptor.h>

namespace IT_SampleArtixInterceptor
{
1   class ServerInterceptor :
      public virtual IT_Bus::ServerRequestInterceptor
      {
      public:
          ServerInterceptor (
              IT_Bus::Bus_ptr      bus
          );

          virtual ~ServerInterceptor();

          virtual void
            intercept_pre_dispatch(IT_Bus::ServerOperation& data);

          virtual void
            intercept_post_dispatch(IT_Bus::ServerOperation& data);

      private:
          ServerInterceptor&
            operator = (const ServerInterceptor& rhs);

          ServerInterceptor(const ServerInterceptor& rhs);
2   IT_Bus::Bus_ptr      m_bus;
      };
};

```

The preceding code can be explained as follows:

1. The `ServerInterceptor` implementation class inherits from the `IT_Bus::ServerRequestInterceptor` base class.
2. The `m_bus` member variable stores a reference to the `Bus` object.

## C++ server request interceptor implementation

**Example 18** shows the implementation of the `IT_SampleArtixInterceptor::ServerInterceptor` class.

### **Example 18:** *Sample Server Request Interceptor Implementation*

```

// C++
// In file: samples/advanced/custom_interceptor/
//
    cxx/plugin/server_interceptor.cxx
#include "server_interceptor.h"

using namespace IT_Bus;
using namespace IT_WSDL;
using namespace IT_SampleArtixInterceptor;

IT_USING_NAMESPACE_STD

1 ServerInterceptor::ServerInterceptor(
    Bus_ptr      bus
    )
    : m_bus(bus)
    {
    }

ServerInterceptor::~ServerInterceptor() { }

void
2 ServerInterceptor::intercept_pre_dispatch(
    IT_Bus::ServerOperation& data
    )
    {
3     cout << "\tServer interceptor intercept_pre_dispatch invoked"
        << "\tOperation called: " << data.get_name() << endl;
4     // -----> PRE-INVOKE processing comes here <-----

        if (ServerRequestInterceptor::m_next_interceptor != 0)
        {
5     ServerRequestInterceptor::m_next_interceptor->intercept_pre_dispatch(data);

```

**Example 18:** *Sample Server Request Interceptor Implementation*

```

    }
}

void
6 ServerInterceptor::intercept_post_dispatch(
  IT_Bus::ServerOperation& data
)
{
  cout << "\tServer interceptor intercept_post_dispatch "
        << "invoked \tReturn from operation: "
        << data.get_name() << endl;
7  // -----> POST-INVOKE processing comes here <-----

  if (ServerRequestInterceptor::m_prev_interceptor != 0)
  {
8  ServerRequestInterceptor::m_prev_interceptor->intercept_post_dis
    patch(data);

  }
}

```

The preceding code can be explained as follows:

1. The `ServerInterceptor` constructor is called by the interceptor factory at the time the interceptor chain is constructed (see [“Implementation of the Interceptor Factory” on page 73](#)). Here you should initialize a local reference to the Bus, `m_bus`, and the interceptor name, `m_name`.
2. The `intercept_pre_dispatch()` function is called before the incoming request has been dispatched to the service endpoint. This key function gives you a chance to access the request before it is executed on the server side.
3. Print the name of the invoked WSDL operation to standard output. For simplicity, in this demonstration the operation name is printed using `cout`. In general, however, it is better practice to use the Artix logging feature.
4. At this point (prior to invoking `intercept_pre_dispatch()` on the next interceptor), you can add any processing that needs to complete *before* invoking the WSDL operation.

5. Invoke `intercept_pre_dispatch()` on the next interceptor in the chain. This step is mandatory for almost all interceptors (a possible exception being a security interceptor that decides to prevent an invocation from proceeding).
6. The `intercept_post_dispatch()` function is called after the incoming request has been dispatched to the service endpoint, but before the output parts have been marshalled.
7. The post-invoke processing should *precede* the call on the next interceptor in the chain.
8. Invoke `intercept_post_dispatch()` on the previous interceptor in the chain. This step is mandatory.



---

## Implementation of the Interceptor Factory

---

### Overview

Artix uses a factory pattern to manage the lifecycle of interceptor objects. To install a set of interceptors, you must implement an interceptor factory and register an instance of this factory with the interceptor factory manager object. The interceptor factory exposes functions that the Artix runtime can then call to create new interceptor instances.

Request interceptors are created by the following functions:

- `get_client_request_interceptor()`
- `get_server_request_interceptor()`

Message interceptors are created by the following functions:

- `get_client_message_interceptor()`
- `get_server_message_interceptor()`

If a particular kind of interceptor is not implemented, you can indicate this with a return value of 0. The interceptor is then omitted from the chain.

---

### The InterceptorFactory base class

[Example 19](#) shows the declarations of the `IT_Bus::InterceptorFactory` class, which is the base class for an interceptor factory.

#### Example 19: *The IT\_Bus::InterceptorFactory Class*

```
// C++
// In file: it_bus_pdk/interceptor.h
...
namespace IT_Bus {
    class IT_BUS_API InterceptorFactory
    {
    public:
        virtual ClientMessageInterceptor *
        get_client_message_interceptor(
            const IT_WSDL::WSDLNode* const wsdl_node = 0
        );

        virtual void destroy_client_message_interceptor(
            ClientMessageInterceptor * message_interceptor
        );
    };
};
```

**Example 19:** *The IT\_Bus::InterceptorFactory Class*

```

virtual ClientRequestInterceptor *
get_client_request_interceptor(
    const IT_WSDL::WSDLNode* const wsdl_node = 0
);

virtual void destroy_client_request_interceptor(
    ClientRequestInterceptor * request_interceptor
);

virtual ServerMessageInterceptor*
get_server_message_interceptor(
    const IT_WSDL::WSDLNode* const wsdl_node = 0
);

virtual void destroy_server_message_interceptor(
    ServerMessageInterceptor* message_interceptor
);

virtual ServerRequestInterceptor*
get_server_request_interceptor(
    const IT_WSDL::WSDLNode* const wsdl_node = 0
);

virtual void destroy_server_request_interceptor(
    ServerRequestInterceptor* request_interceptor
);

virtual const String& name() = 0;

protected:
    ...
};
};

```

**C++ interceptor factory header**

**Example 20** shows the declaration of the

IT\_SampleArtixInterceptor::SampleBusPlugIn class, which implements the IT\_Bus::InterceptorFactory class.

**Example 20:** *Sample Interceptor Factory Header File*

```

// C++
// In file: samples/advanced/shared_library/
// cxx/plugin/plugin.cxx

```

**Example 20:** *Sample Interceptor Factory Header File*

```

...
namespace IT_SampleArtixInterceptor
{
1   class SampleBusPlugIn :
      public IT_Bus::BusPlugIn,
      public IT_Bus::InterceptorFactory
      {
      public:
          IT_EXPLICIT
          SampleBusPlugIn(
              IT_Bus::Bus_ptr bus
          ) IT_THROW_DECL((IT_Bus::Exception));

          virtual ~SampleBusPlugIn();

2          // IT_Bus::BusPlugIn
          //
          ... // Not shown.

3          //IT_Bus::InterceptorFactory
          //
          virtual IT_Bus::ClientMessageInterceptor *
          get_client_message_interceptor(
              const IT_WSDL::WSDLNode* const wsdl_node = 0
          );

          virtual void destroy_client_message_interceptor(
              IT_Bus::ClientMessageInterceptor* message_interceptor
          );

          virtual IT_Bus::ClientRequestInterceptor *
          get_client_request_interceptor(
              const IT_WSDL::WSDLNode* const wsdl_node = 0
          );

          virtual void destroy_client_request_interceptor(
              IT_Bus::ClientRequestInterceptor * request_interceptor
          );

          virtual IT_Bus::ServerMessageInterceptor*
          get_server_message_interceptor(
              const IT_WSDL::WSDLNode* const wsdl_node = 0
          );
      };
}

```

**Example 20:** *Sample Interceptor Factory Header File*

```

    virtual void destroy_server_message_interceptor(
        IT_Bus::ServerMessageInterceptor* message_interceptor
    );

    virtual IT_Bus::ServerRequestInterceptor*
    get_server_request_interceptor(
        const IT_WSDL::WSDLNode* const wsdl_node = 0
    );

    virtual void destroy_server_request_interceptor(
        IT_Bus::ServerRequestInterceptor* request_interceptor
    );

    virtual const IT_Bus::QName& name();

private:
    SampleBusPlugIn(const SampleBusPlugIn&);

    SampleBusPlugIn&
    operator=(const SampleBusPlugIn&);

    IT_Bus::String m_name;
};

```

The preceding code can be explained as follows:

1. In this example, the `IT_Bus::InterceptorFactory` base class is implemented by the plug-in class, `SampleBusPlugIn`. If you prefer, you could implement `IT_Bus::InterceptorFactory` using a separate class instead.
2. The implementation of the functions inherited from the `IT_Bus::BusPlugIn` base class is discussed in another chapter—see [“Basic Plug-In Implementation” on page 25](#).
3. From this point on, all of the functions shown are inherited from `IT_Bus::InterceptorFactory`.
4. The `m_name` variable is used to store the interceptor name.

## C++ interceptor factory implementation

Example 21 shows the implementation of the `IT_SampleArtixInterceptor::SampleBusPlugIn` class.

### Example 21: *Sample Interceptor Factory Implementation*

```
// C++

using namespace IT_Bus;
using namespace IT_WSDL;
using namespace IT_SampleArtixInterceptor;

// SampleBusPlugIn
//

SampleBusPlugIn:: SampleBusPlugIn(
    IT_Bus::Bus_ptr bus
) IT_THROW_DECL((IT_Bus::Exception))
:
    BusPlugIn(bus),
    m_name("artix_shlib_interceptor")
{
    assert(bus != 0);
}

SampleBusPlugIn::~SampleBusPlugIn() { }

// IT_Bus::BusPlugIn functions
//
void
SampleBusPlugIn::bus_init(
) IT_THROW_DECL((IT_Bus::Exception))
{
    IT_Bus::Bus_ptr bus = get_bus();
    assert(bus != 0);

1    InterceptorFactoryManager& factory_manager =
        bus->get_pdk_bus()->get_interceptor_factory_manager();

2    factory_manager.register_interceptor_factory(
        m_name,
        this
    );
}
```

**Example 21:** *Sample Interceptor Factory Implementation*

```

void
SampleBusPlugIn::bus_shutdown(
) IT_THROW_DECL((IT_Bus::Exception))
{
    IT_Bus::Bus_ptr bus = get_bus();
    assert(bus != 0);

    InterceptorFactoryManager& factory_manager =
        bus->get_pdk_bus()->get_interceptor_factory_manager();

3    factory_manager.unregister_interceptor_factory(
        this
    );
}

// IT_Bus::InterceptorFactory functions
//
ClientMessageInterceptor *
4 SampleBusPlugIn::get_client_message_interceptor(
    const WSDLNode* const
)
{
    return 0;
}

void
5 SampleBusPlugIn::destroy_client_message_interceptor(
    ClientMessageInterceptor* message_interceptor
)
{
    delete message_interceptor;
}

ClientRequestInterceptor *
6 SampleBusPlugIn::get_client_request_interceptor(
    const WSDLNode* const
)
{
    return new ClientInterceptor(get_bus());
}

void
7 SampleBusPlugIn::destroy_client_request_interceptor(
    ClientRequestInterceptor * request_interceptor
)

```

**Example 21:** *Sample Interceptor Factory Implementation*

```

{
    delete request_interceptor;
}

ServerMessageInterceptor*
SampleBusPlugIn::get_server_message_interceptor(
    const WSDLNode* const
)
{
    return 0;
}

void
SampleBusPlugIn::destroy_server_message_interceptor(
    ServerMessageInterceptor* message_interceptor
)
{
    delete message_interceptor;
}

ServerRequestInterceptor*
8 SampleBusPlugIn::get_server_request_interceptor(
    const WSDLNode* const
)
{
    return new ServerInterceptor(get_bus());
}

void
9 SampleBusPlugIn::destroy_server_request_interceptor(
    ServerRequestInterceptor* request_interceptor
)
{
    delete request_interceptor;
}

const String&
10 SampleBusPlugIn::name()
{
    return m_name;
}

```

The preceding code can be explained as follows:

1. The `IT_Bus::InterceptorFactoryManager` object stores a list of all interceptor factories. It is implemented by the Artix runtime.
2. You must register the interceptor factory instance with the interceptor factory manager, as shown here. The `register` function takes the interceptor name, `m_name`, and the interceptor factory instance, `this`, as arguments.
3. You usually unregister the interceptor factory in the body of the `IT_Bus::BusPlugIn::bus_shutdown()` function to ensure a clean shutdown of the Artix Bus.
4. You would implement the `get_client_message_interceptor()` function to install a client message interceptor. In this example, the function returns 0 to indicate that a client message interceptor is not available.
5. The `destroy_client_message_interceptor()` function would be called by the Artix runtime to clean up resources associated with the client message interceptor.
6. The Artix runtime calls `get_client_request_interceptor()` in the course of constructing a new interceptor chain to obtain a client request interceptor instance.

The `get_client_request_interceptor()` function takes the following arguments:

- ◆ `wsdl_node`—(defaults to 0).

In this example, the implementation of `get_client_request_interceptor()` simply returns a new client interceptor object.

7. The `destroy_client_request_interceptor()` function is called by the Artix runtime to clean up resources associated with the client request interceptor.
8. The Artix runtime calls `get_server_request_interceptor()` in the course of constructing a new interceptor chain to obtain a server request interceptor instance.

The `get_server_request_interceptor()` function takes the following arguments:

- ◆ `wsdl_node`—(defaults to 0).



In this example, the implementation of `get_server_request_interceptor()` simply returns a new server interceptor object.

9. The `destroy_server_request_interceptor()` function is called by the Artix runtime to clean up resources associated with the server request interceptor.
10. The `name()` function returns the interceptor name.

---

# Accessing and Modifying Parameters

---

## Overview

Artix interceptors enable you to access and modify both input and output parameters, as a message passes back and forth along the interceptor chain. On the client side, the input and output parameters are accessible from the `IT_Bus::ClientOperation` object. On the server side, the input and output parameters are accessible from the `IT_Bus::ServerOperation` object.

---

## In this section

This section contains the following subsections:

<a href="#">Reflection Example</a>	<a href="#">page 83</a>
<a href="#">Implementation of the Client Request Interceptor</a>	<a href="#">page 86</a>
<a href="#">Implementation of the Server Request Interceptor</a>	<a href="#">page 91</a>

---

## Reflection Example

---

### Overview

In order to access and modify operation parameters from within an interceptor, it is essential to use the Artix reflection API. In contrast to code written at the application level, an interceptor must typically be able to process any port type or operation. Hence, an interceptor implementation must be able to parse any parameter type; this capability is provided by the Artix reflection API.

To access operation parameters from within an interceptor, you would typically need to use the following APIs:

- [Part list type](#).
  - [Reflection API](#).
- 

### Part list type

Given either an `IT_Bus::ClientOperation` instance or an `IT_Bus::ServerOperation` instance, data, you can access the input parts and the output parts as follows:

- To obtain a reference to the *input* part list, call:  
`data.get_input_message().get_parts()`
- To obtain a reference to the *output* part list, call:  
`data.get_output_message().get_parts()`

The returned part list (of `IT_Bus::PartList&` type) is essentially a vector of (`IT_Bus::QName`, `IT_Bus::AnyType*`) pairs.

---

### Reflection API

The reflection API enables you to parse any Artix data type and to process the data without any advance knowledge of its type. For the example described in this section, you need only the following classes:

- `IT_Reflect::Reflection` class—the base class for all reflection types.
  - `IT_Reflect::Value<IT_Bus::String>` class—the reflection type that represents a string.
  - `IT_Bus::Var<T>` template—a smart pointer template type that ensures that the referenced data is not leaked.
- 

### Reflection interceptor demonstration

The sample code in this section is taken from the following Artix demonstration: *ArtixInstallDir/samples/reflection/interceptor*

**Example 22** shows the WSDL definition of the `Greeter` port type that is used in this demonstration.

**Example 22:** *The Greeter Port Type*

```
<?xml version="1.0" encoding="UTF-8"?>
<wsdl:definitions
  name="HelloWorld"
  targetNamespace="http://www.iona.com/reflect_interceptor"
  xmlns="http://schemas.xmlsoap.org/wsdl/"
  xmlns:tns="http://www.iona.com/reflect_interceptor"
  xmlns:wSDL="http://schemas.xmlsoap.org/wsdl/"
  xmlns:xsd="http://www.w3.org/2001/XMLSchema" ... >
  <wsdl:types>
    <schema
      targetNamespace="http://www.iona.com/reflect_interceptor"
      xmlns="http://www.w3.org/2001/XMLSchema">
      <element name="responseType" type="xsd:string"/>
      <element name="requestType" type="xsd:string"/>
    </schema>
  </wsdl:types>

  <wsdl:message name="sayHiRequest" />
  <wsdl:message name="sayHiResponse">
    <wsdl:part element="tns:responseType"
      name="theResponse" />
  </wsdl:message>
  <wsdl:message name="greetMeRequest">
    <wsdl:part element="tns:requestType" name="me" />
  </wsdl:message>
  <wsdl:message name="greetMeResponse">
    <wsdl:part element="tns:responseType"
      name="theResponse" />
  </wsdl:message>

  <wsdl:portType name="Greeter">
    <wsdl:operation name="sayHi">
      <wsdl:input message="tns:sayHiRequest"
        name="sayHiRequest" />
      <wsdl:output message="tns:sayHiResponse"
        name="sayHiResponse" />
    </wsdl:operation>
    <wsdl:operation name="greetMe">
      <wsdl:input message="tns:greetMeRequest"
        name="greetMeRequest" />
      <wsdl:output message="tns:greetMeResponse"
        name="greetMeResponse" />
    </wsdl:operation>
  </wsdl:portType>
</wsdl:definitions>
```

**Example 22:** *The Greeter Port Type*

```
</wsdl:operation>  
</wsdl:portType>  
...  
</wsdl:definitions>
```

---

## Implementation of the Client Request Interceptor

---

### Overview

This subsection describes how to implement a client request interceptor that uses reflection to modify an operation's input and output parameters.

**Note:** This example is only intended to be used in conjunction with the Greeter port type, as defined in [Example 22 on page 84](#).

### C++ client request interceptor header

[Example 23](#) shows the header for the `ClientInterceptor` class, which is derived from the `IT_Bus::ClientRequestInterceptor` base class.

#### **Example 23:** *Client Interceptor Header for Reflection Example*

```
// C++
#include <it_bus/bus.h>
#include <it_bus/qname.h>
#include <it_bus_pdk/interceptor.h>

class ClientInterceptor :
    public virtual IT_Bus::ClientRequestInterceptor
{
public:
    ClientInterceptor(
        IT_Bus::Bus_ptr bus
    );

    virtual ~ClientInterceptor();

    virtual void
    intercept_invoke(
        IT_Bus::ClientOperation& data
    );

private:
    IT_Bus::Bus_ptr m_bus;
};
```

## C++ client request interceptor implementation

Example 24 shows the implementation of the ClientInterceptor class.

### Example 24: Client Interceptor Implementation for Reflection Example

```

// C++
#include "client_interceptor.h"
#include <it_bus/operation.h>
#include <it_bus/part_list.h>
#include <it_bus/reflect/value.h>
#include <it_cal/iostream.h>

IT_USING_NAMESPACE_STD;
using namespace IT_Bus;

ClientInterceptor::ClientInterceptor(
    Bus_ptr    bus
)
    : m_bus(bus)
{
    // Complete
}

ClientInterceptor::~ClientInterceptor()
{
    // Complete
}

void
1 ClientInterceptor::intercept_invoke(
    ClientOperation& data
)
{
    // Get the value of the input part using reflection.
    // Client-side input parts are "serializable" that is they
    // will be serialized to the underlying transport.
    // Serializable parts are read-only.
    //
2 PartList& input_parts = data.get_input_message().get_parts();
3 if (input_parts.size() == 1)
    {
4     Var<const IT_Reflect::Reflection> r =
        input_parts[0].get_const_value().get_reflection();
5     Var<const IT_Reflect::Value<String> > input_reflection =
        dynamic_cast_var<const IT_Reflect::Value<String> >(r);
        assert(input_reflection.get());
    }
}

```

**Example 24:** *Client Interceptor Implementation for Reflection Example*

```

        String input_string = input_reflection->get_value();

        // Print a message
        //
6       String replace_input = input_string + ",1";
        cout << "[Client pre-invoke intercepted: "
            << input_string << "]" << endl;
        cout << "[Replacing with " << replace_input << "]" <<
endl;

        // Replace the part before calling next interceptor.
        //
7       set_const_value(input_parts[0], replace_input);
    }

    // Call the next interceptor
    //
8       m_next_interceptor->intercept_invoke(data);

    // Get the value of the output string using reflection.
    //
9       PartList& output_parts =
data.get_output_message().get_parts();
    if (output_parts.size() == 1)
    {
        Var<IT_Reflect::Reflection> r2 =

output_parts[0].get_modifiable_value().get_reflection();
        Var<IT_Reflect::Value<String> > output_reflection =
            dynamic_cast_var<IT_Reflect::Value<String> >(r2);
        assert(output_reflection.get());
        String output_string = output_reflection->get_value();

        // Print a message
        //
        String replace_output = output_string + ",4";
        cout << "[Client post-invoke intercepted: " <<
output_string << "]"
            << endl;
        cout << "[Replacing with " << replace_output << "]" <<
endl;

        // Modify the value of the output part. This directly
        // modifies the underlying application data value.
        //

```



**Example 24:** *Client Interceptor Implementation for Reflection Example*

```

        output_reflection->set_value(replace_output);
    }
}

```

The preceding interceptor implementation can be explained as follows:

1. This implementation of `intercept_invoke()` is designed to modify the parameters of the `sayHi` and `greetMe` WSDL operations by adding a short string to the input parameter and to the output parameter.
2. The returned part list, `input_parts`, contains all of the WSDL parts containing input parameters for the operation. A part list is essentially a vector of `(IT_Bus::QName, IT_Bus::AnyType*)` pairs. The `IT_Bus::AnyType` is the base type for all WSDL types in Artix.
3. The code in this `if`-block uses reflection to modify the first input part. This example is hard-coded to work *only* with the `sayHi` and `greetMe` operation from the `Greeter` port type. The example modifies the request message, only if it consists of a single part which is a string.
4. From the first (and only) pair in the part list, return the `const IT_Bus::AnyType` value (using `get_const_value()`) and convert it into a reflection object (using `get_reflection()`).
5. Assuming that the part contains a string, cast the reflection object to a string reflection.  
This step is only intended to work for the `Greeter` port type. In the general case, you would have to use the reflection interface to figure out the data type.
6. Define a modified string, `replace_input`, which adds `,1` to the original string.

7. Call `set_const_value()` to replace the sole input part in the request. The `set_const_value()` function is a convenience template, which is used only for simple types. It is defined in `it_bus/part.h` as follows:

```
// C++
namespace IT_Bus {
    template <class T>
    void set_const_value(
        Part&      part,
        T&         value
    )
    {
        part.set_const_value(
            new AnySimpleTypeT<T>(value), Part::AUTO_DELETE);
    }
}
```

The `IT_Bus::Part::set_const_value()` function takes an `IT_Bus::AnyType` as its first parameter. Because simple atomic types, such as `IT_Bus::String`, do not inherit from `AnyType`, it is necessary to wrap them in an `IT_Bus::AnySimpleTypeT<T>` instance, which does inherit from `AnyType`.

For user-defined types (and other types that inherit from `AnyType`), you can pass them directly to the `IT_Bus::Part::set_const_value()` function.

8. The obligatory call to delegate to the next interceptor in the chain.
9. In the reply message, modify the output, only if it consists of a single part containing a string (intended for the `Greeter` port type only).

---

## Implementation of the Server Request Interceptor

---

### Overview

This subsection describes how to implement a server request interceptor that uses reflection to modify an operation's input and output parameters.

**Note:** This example is only intended to be used in conjunction with the `Greeter` port type, as defined in [Example 22 on page 84](#).

### C++ server request interceptor header

[Example 25](#) shows the header for the `ServerInterceptor` class, which is derived from the `IT_Bus::ServerRequestInterceptor` base class.

#### **Example 25:** *Server Interceptor Header for Reflection Example*

```
// C++
#include <it_bus/qname.h>
#include <it_bus/bus.h>
#include <it_bus_pdk/interceptor.h>

class ServerInterceptor :
    public virtual IT_Bus::ServerRequestInterceptor
{
public:
    ServerInterceptor(
        IT_Bus::Bus_ptr      bus
    );

    virtual ~ServerInterceptor();

    virtual void
    intercept_pre_dispatch(
        IT_Bus::ServerOperation& data
    );

    virtual void
    intercept_post_dispatch(
        IT_Bus::ServerOperation& data
    );

private:
    IT_Bus::Bus_ptr      m_bus;
};
```

**C++ server request interceptor implementation**

[Example 26](#) shows the implementation of the `ServerInterceptor` class.

**Example 26:** *Server Interceptor Implementation for Reflection Example*

```

// C++
#include <it_bus/operation.h>
#include <it_bus/reflect/value.h>
#include <it_bus/part_list.h>
#include "server_interceptor.h"

using namespace IT_Bus;
using namespace IT_WSDL;
IT_USING_NAMESPACE_STD

ServerInterceptor::ServerInterceptor(
    Bus_ptr      bus
)
    : m_bus(bus)
{
    // Complete.
}

ServerInterceptor::~ServerInterceptor()
{
    // Complete.
}

void
1 ServerInterceptor::intercept_pre_dispatch(
    IT_Bus::ServerOperation& data
)
{
    // Get the value of the input string using reflection.
    // The value points to the value unmarshalled from the wire.
    //
2 PartList& input_parts = data.get_input_message().get_parts();
3 if (input_parts.size() == 1)
    {
4         Var<IT_Reflect::Reflection> r =
            input_parts[0].get_modifiable_value().get_reflection();
5         Var<IT_Reflect::Value<String> > input_reflection =
            dynamic_cast_var<IT_Reflect::Value<String> >(r);
            assert(input_reflection.get());
            String input_string = input_reflection->get_value();
    }
}

```

**Example 26:** *Server Interceptor Implementation for Reflection Example*

```

        // Print a message
        //
6      String replace_input = input_string + ",2";
        cout << "[Server pre-invoke intercepted: "
            << input_string << "]" << endl;
        cout << "[Replacing with " << replace_input << "]"
            << endl;

        // Modify the value of the input part before the server
        // sees it.
7      input_reflection->set_value(replace_input);
    }

    if (m_next_interceptor != 0)
    {
        m_next_interceptor->intercept_pre_dispatch(data);
    }
}

void
8 ServerInterceptor::intercept_post_dispatch(
    IT_Bus::ServerOperation& data
)
{
    // Get the value of the output part using reflection.
    //
    PartList& output_parts =
    data.get_output_message().get_parts();
9    if (output_parts.size() == 1)
    {
        Var<const IT_Reflect::Reflection> r =
            output_parts[0].get_const_value().get_reflection();
        Var<const IT_Reflect::Value<String> > output_reflection =
            dynamic_cast_var<const IT_Reflect::Value<String>
>(r);
        assert(output_reflection.get());
        String output_string = output_reflection->get_value();

        // Print a messageppp
        //
        String replace_output = output_string + ",3";
        cout << "[Server post-invoke intercepted: "
            << output_string << "]" << endl;
        cout << "[Replacing with " << replace_output << "]" <<
endl;
    }
}

```

**Example 26:** *Server Interceptor Implementation for Reflection Example*

10

```

        // Replace the value before calling next interceptor.
        //
        set_const_value(output_parts[0], replace_output);
    }

    if (m_prev_interceptor != 0)
    {
        m_prev_interceptor->intercept_post_dispatch(data);
    }
}

```

The preceding interceptor implementation can be explained as follows:

1. The implementation of `intercept_pre_dispatch()` is designed to modify the input parameter of the `sayHi` and `greetMe` WSDL operations by appending a short string.
2. The returned part list, `input_parts`, contains all of the WSDL parts containing input parameters for the operation. A part list is essentially a vector of `(IT_Bus::QName, IT_Bus::AnyType*)` pairs. The `IT_Bus::AnyType` is the base type for all WSDL types in Artix.
3. The code in this `if`-block uses reflection to modify the first input part. This example is hard-coded to work *only* with the `sayHi` and `greetMe` operation from the `Greeter` port type. The example modifies the request message, only if it consists of a single part which is a string.
4. From the first (and only) pair in the part list, return the `IT_Bus::AnyType` value (using `get_modifiable_value()`) and convert it into a reflection object (using `get_reflection()`).
5. Assuming that the part contains a string, cast the reflection object to a string reflection.  
This step is only intended to work for the `Greeter` port type. In the general case, you would have to use the reflection interface to figure out the data type.
6. Define a modified string, `replace_input`, which adds `,2` to the original string.
7. Call `IT_Reflect::Value<String>::set_value()` to modify the input part in the request.

8. The implementation of `intercept_post_dispatch()` is designed to modify the output parameter of the `sayHi` and `greetMe` WSDL operations by appending a short string.
9. In the reply message, modify the output, only if it consists of a single part containing a string (intended for the `Greeter` port type only).
10. Call `set_const_value()` to replace the sole output part in the request. The `set_const_value()` function is a convenience template, which sets the part value to a simple type. It is defined in `it_bus/part.h` as follows:

```
// C++
namespace IT_Bus {
    template <class T>
    void set_const_value(
        Part&      part,
        T&         value
    )
    {
        part.set_const_value(
            new AnySimpleTypeT<T>(value), Part::AUTO_DELETE);
    }
}
```

The `IT_Bus::Part::set_const_value()` function takes an `IT_Bus::AnyType` as its first parameter. Because simple atomic types, such as `IT_Bus::String`, do not inherit from `AnyType`, it is necessary to wrap them in an `IT_Bus::AnySimpleTypeT<T>` instance, which does inherit from `AnyType`.

For user-defined types (and other types that inherit from `AnyType`), you can pass them directly to the `IT_Bus::Part::set_const_value()` function.

---

# Raising Exceptions

---

## Overview

Artix allows you to raise exceptions in request interceptors, but you must raise the exception at the appropriate place.

---

## Where to raise an exception

There are specific places in the interceptor code where you can raise exceptions, as follows:

- *Client request interceptor*—in the body of the `intercept_invoke()` function, either before or after the follow-on invocation to the next interceptor.
  - *Server request interceptor*—in the body of the `intercept_around_dispatch()` function, either before or after the follow-on invocation to the next interceptor. In particular, you *cannot* raise an exception in the body of an `intercept_pre_dispatch()` or `intercept_post_dispatch()` function.
- 

## Type of exceptions you can raise

You can raise the following types of exception in an interceptor:

- `IT_Bus::FaultException` (standard Artix exceptions),
  - `IT_Bus::UserFaultException` (user-defined custom exceptions).
- 

## Examples of exception raising

The following examples show how to raise an `IT_Bus::FaultException` in an interceptor:

- [Raising a fault exception in a client interceptor.](#)
- [Raising a fault exception in a server interceptor.](#)



## Raising a fault exception in a client interceptor

Example 27 shows how to raise a `NO_PERMISSION` fault exception in the body of a client interceptor's `intercept_invoke()` function.

### Example 27: Raising a Fault Exception in a Client Interceptor

```

// C++
void
ClientInterceptor::intercept_invoke(
    ClientOperation& data
)
{
    if ( ... ) // If some error condition occurs...
    {
1      IT_Bus::String error = "You don't have permission!";
      IT_Bus::FaultException exc(
2          IT_Bus::FaultCategory::NO_PERMISSION,
3          "http://schemas.YourCompany.com/exceptions",
          error
          );
4      exc.set_description(error);
5      exc.set_completion_status(
          IT_Bus::FaultCompletionStatus::NO
          );
      exc.set_source(IT_Bus::FaultSource::CLIENT);
      throw exc;
    }

    // Call the next interceptor
    m_next_interceptor->intercept_invoke(data);
}

```

The preceding code fragment can be explained as follows:

1. The `IT_Bus::FaultException` type is the appropriate type of exception to raise for the typical errors that occur during an operation invocation. The constructor takes three arguments, as follows:
  - ◆ *Fault category*—faults must be classified into one of the standard categories, which are enumerated in the `it_bus/fault_exception.h` header file.
  - ◆ *Namespace URI*—it is recommended to use a custom namespace for your fault exceptions (for example, `http://schemas.YourCompany.com/exceptions`). This enables

you to distinguish your fault exceptions from the Artix fault exceptions (which conventionally belong to the `http://schemas.iona.com/exceptions` namespace).

- ◆ *Error code*—a string code. This is typically a description of the error condition.
2. The description is identical to the error code.
  3. The completion status is `NO`, because this exception is raised *before* the operation is invoked.
  4. The source is set to `CLIENT`, because the exception is raised on the client side.
  5. Use the standard C++ `throw` mechanism to raise the exception.

### Raising a fault exception in a server interceptor

**Example 28** shows how to raise a `TIMEOUT` fault exception in the body of a server interceptor's `intercept_around_dispatch()` function.

#### **Example 28:** *Raising a Fault Exception in a Client Interceptor*

```

// C++
using namespace IT_Bus;

void
ServerInterceptor::intercept_around_dispatch(
    ServerOperation& data
)
{
    // PRE-UNMARSHAL processing
    // ...

    if ( ... ) // If some error condition occurs...
    {
        IT_Bus::String error = "Something took too long!";
        IT_Bus::FaultException exc(
            IT_Bus::FaultCategory::TIMEOUT,
            "http://schemas.YourCompany.com/exceptions",
            error
        );
        exc.set_description(error);
        1 exc.set_completion_status(
            IT_Bus::FaultCompletionStatus::NO
        );
        2 exc.set_source(IT_Bus::FaultSource::SERVER);
        3 throw exc;
    }
}

```

**Example 28:** *Raising a Fault Exception in a Client Interceptor*

```
    }  
  
    // Call the next interceptor  
    if (m_next_interceptor != 0) {  
        m_next_interceptor->intercept_around_dispatch(data);  
    }  
  
    // POST-MARSHAL processing  
    // ...  
}
```

The preceding code fragment can be explained as follows:

1. The completion status is `NO`, because this exception is raised *before* the operation is invoked.
2. The source is set `SERVER`, because this exception is raised on the server side.
3. Use the standard C++ `throw` mechanism to raise the exception.



# WSDL Extension Elements

*If you implement your own transport or binding plug-in, you would typically configure it by defining a custom tag (or tags) in the WSDL contract. This chapter describes how to add a custom tag—that is, a WSDL extension element—to the Artix WSDL parser.*

---

**In this chapter**

This chapter discusses the following topics:

<a href="#">WSDL Structure</a>	<a href="#">page 104</a>
<a href="#">WSDL Parse Tree</a>	<a href="#">page 106</a>
<a href="#">How to Extend WSDL</a>	<a href="#">page 110</a>
<a href="#">Extension Elements for the Stub Plug-In</a>	<a href="#">page 113</a>

---

# WSDL Structure

## Overview

This section describes some basic features of the WSDL language that are important for WSDL parsing. The following topics are discussed:

- [WSDL Example](#).
- [Standard elements](#).
- [Extensibility/extension elements](#).

## WSDL Example

[Example 29](#) shows the outline of a typical WSDL file, including the important high-level elements that you would find in most WSDL files.

### Example 29: WSDL Contract with Extensibility Elements

```
<wsdl:definitions name="nmtoken"? targetNamespace="uri"?>
  <wsdl:types? >
    <xsd:schema .... /*
      <!-- extensibility element --> *
    </wsdl:types>
    ....
  <wsdl:binding name="nmtoken" type="qname">*
    <!-- extensibility element --> *
    <wsdl:operation .... /*
  </wsdl:binding>
  <wsdl:service name="nmtoken"> *
    <wsdl:port name="nmtoken" binding="qname"> *
      <!-- extensibility element -->
    </wsdl:port>
    <!-- extensibility element -->
  </wsdl:service>
  <!-- extensibility element --> *
</wsdl:definitions>
```

## Standard elements

The core of WSDL defines many standard XML elements (in [Example 29 on page 104](#), these tags appear without any prefix before their names). For example, portType, binding, and service. These elements belong to the *base WSDL specification*.

---

**Extensibility/extension elements**

In addition to the standard elements, the WSDL standard allows you to extend the language by adding new WSDL elements known as *extensibility elements* or *extension elements*.

The WSDL standard does impose some restrictions, however, on where you can add these extension elements (see appendix 3 of the [WSDL specification](http://www.w3.org/TR/wsdl), <http://www.w3.org/TR/wsdl>).

---

# WSDL Parse Tree

---

## Overview

When an Artix application reads a WSDL file, the complete contents of the file are parsed and analyzed into a linked tree of objects, the *WSDL parse tree*. There are, in fact, two views of this tree, as follows:

- **XML view**—this view of the parse tree is provided by the `IT_Bus:XMLNode` base class. This view of the parse tree provides XML parsing support, but has no awareness of WSDL features.
- **WSDL view**—this view of the parse tree is provided by classes that inherit from `IT_WSDL:WSDLNode`. This view of the parse tree provides support for WSDL features.

This section focuses exclusively on the WSDL view of the parse tree. You should be aware, however, that you might also encounter the parse tree through the XML view. An `IT_Bus:XMLNode` object and an `IT_WSDL:WSDLNode` object can both refer to the same underlying node in the parse tree.



## Parse tree classes

Figure 7 shows part of the inheritance hierarchy for the classes in a WSDL parse tree. The WSDL nodes are classified into two main types:

- `IT_WSDL::WSDLExtensibleNode` nodes—base class for standard elements.
- `IT_WSDL::WSDLExtensionElement` nodes—base class for extension elements.

**Figure 7:** *WSDL Parse Tree Inheritance Hierarchy*

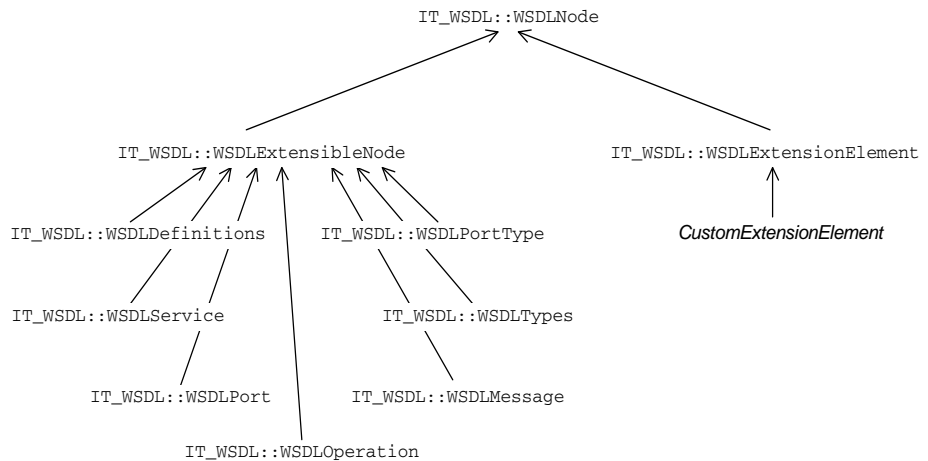

## WSDLNode

The `IT_WSDL::WSDLNode` class is the base class for all nodes of the WSDL parse tree. It defines the following public member functions:

```

// C++
IT_WSDL::NodeType get_node_type();

// Get the QName of this element node
const IT_Bus::QName & get_element_name();

// Get the namespace URI for this element node
const IT_Bus::String & get_target_namespace();
  
```

## WSDLExtensibleNode

The `IT_WSDL::WSDLExtensibleNode` class is used as the base class for the standard elements in WSDL. The nodes that inherit from `WSDLExtensibleNode` are extensible, in the sense that they may contain extension elements as

sub-elements. In addition to the functions inherited from `IT_WSDL::WSDLNode`, the `WSDLExtensibleNode` base class defines the following public member functions:

```
// C++
IT_WSDL::WSDLExtensionElementList & get_extension_elements();

IT_WSDL::WSDLExtensionElement *
find_extension_element(
    const IT_Bus::QName &extension_element
);

IT_WSDL::WSDLExtensionElement *
create_extension_element(
    const IT_Bus::QName &extension_element
);

void
add_extension_element(
    IT_WSDL::WSDLExtensionElement *extension_element
);
```

---

## WSDLPort

The `IT_WSDL::WSDLPort` extensible node represents the WSDL port element. This WSDL node type is important for Artix transports, because it encapsulates all of the information required either to open a connection (client side) or to listen for a connection (server side). The `WSDLPort` class defines the following member functions:

```
// C++
const IT_Bus::String &          get_name ()
const IT_WSDL::WSDLService &   get_service ()
const IT_WSDL::WSDLBinding *   get_binding ()
```

---

## WSDLBinding

The `IT_WSDL::WSDLBinding` extensible node represents the WSDL binding element. This WSDL node type (together with a WSDL port) encapsulates the information that is needed to establish a WSDL binding. The `WSDLBinding` class defines the following member functions:

```
// C++
IT_WSDL::WSDLDefinitions &          get_definitions();
const IT_WSDL::WSDLDefinitions &   get_definitions();
const IT_WSDL::IT_Bus::QName &      get_name();
const IT_WSDL::WSDLBindingOperationMap & get_operations();
IT_WSDL::WSDLBindingOperationMap & get_operations();
const IT_WSDL::IT_Bus::QName &      get_port_type_name();
const IT_WSDL::WSDLPortType *       get_port_type();
```

```

const IT_WSDL::WSDLBindingOperation *
get_binding_operation (
    const IT_Bus::String &operation_name
);

const IT_Bus::String& get_binding_namespace() const;

```

---

## WSDLExtensionElement

The `IT_WSDL::WSDLExtensionElement` is the base class for custom extension elements. If you want to implement your own extension element class, you should make it inherit from `WSDLExtensionElement`. In your own extension element implementation, you must override the following member functions:

```

// C++
IT_WSDL::WSDLExtensionFactory & get_extension_factory();

bool parse(
    const XMLIterator &port_type_iter,
    const IT_Bus::XMLNode &parent_node,
    IT_WSDL::WSDLErrorHandler &error_handler
);

```

---

# How to Extend WSDL

---

## Overview

This section provides a high-level overview of how you can extend the parsing capabilities of WSDL by adding extension elements.

---

## Sample WSDL extensions

For example, consider the MessageQueue (MQ) plug-in for Artix, which introduces two new extension elements, `mq:client` and `mq:server`, to WSDL. These new extension elements belong to the `http://schemas.iona.com/transport/mq` namespace. [Example 30](#) shows a WSDL extract with the MQ extension elements.

### Example 30: WSDL Extract with MQ Extension Elements

```
<?xml version="1.0" encoding="UTF-8"?>
<definitions name="BaseService"
  targetNamespace="http://soapinterop.org/"
  xmlns="http://schemas.xmlsoap.org/wsdl/"
  xmlns:mq="http://schemas.iona.com/transport/mq"
  ...
  >
  ...
  <service name="MQBaseService">
    <port ... >
      <mq:client ... />
      <mq:server ... />
    </port>
  </service>
</definitions>
```

## Factory pattern

The scheme for extending the WSDL parser is based on a factory pattern. The programmer registers an extension factory, which is then responsible for creating instances of the extension elements on demand. Figure 8 illustrates the process of creating extension elements.

**Figure 8:** *Factory Pattern for WSDL Extension Elements*

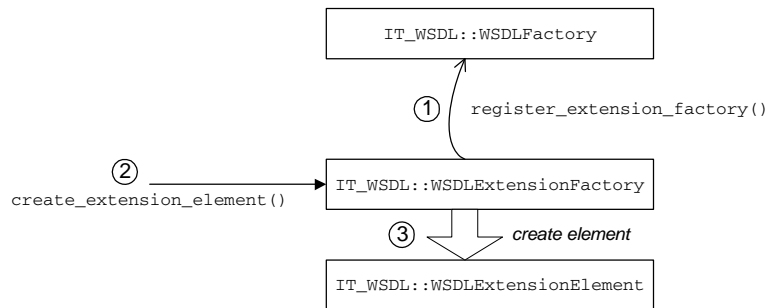

## Factory pattern stages

The factory pattern for creating extension elements, as shown in Figure 8 on page 111, operates as follows:

Stage	Description
1	The programmer registers a custom WSDL extension factory by calling <code>register_extension_factory()</code> on the <code>IT_WSDL::WSDLFactory</code> object.  In this example, the extension factory is registered against the <code>http://schemas.iona.com/transport/mq</code> namespace URI.
2	Whenever the WSDL parser encounters an element belonging to the <code>http://schemas.iona.com/transport/mq</code> namespace, it calls <code>create_extension_element()</code> on the extension factory.
3	The extension factory figures out which type of extension element to create by examining the local part of the supplied QName and then returns a new instance of this extension element type.

**Classes to implement**

Figure 9 shows an outline of the inheritance hierarchy for the classes you would need to write in order to extend WSDL. There are typically three different kinds of class to implement:

- Extension factory—inherits from `IT_WSDL::WSDLExtensionFactory`.
- Extension element base class—inherits from `IT_WSDL::WSDLExtensionElement` and `IT_Bus::XMLNode`.
- Extension elements (one or more of)—inherit from the extension element base class.

**Figure 9:** *Extension Element Classes*

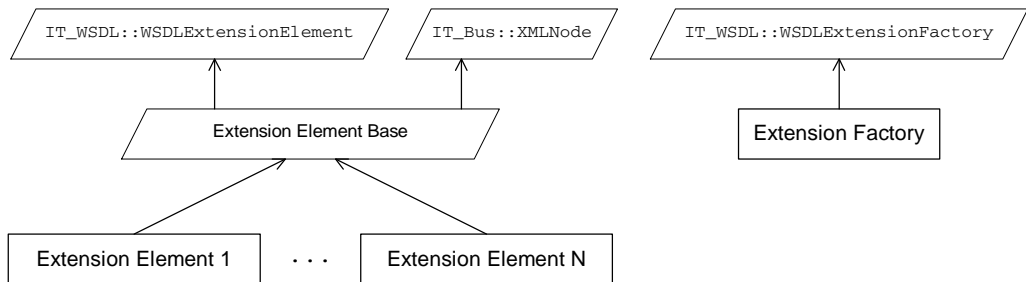

---

# Extension Elements for the Stub Plug-In

---

**Overview**

This section describes how to extend WSDL, by implementing an extension element class and an extension factory class for the stub plug-in. Although the particular example shown here is based on a transport plug-in, this section is relevant for binding plug-ins as well.

---

**In this section**

This section contains the following subsections:

<a href="#">Implementing an Extension Element Base Class</a>	<a href="#">page 114</a>
<a href="#">Implementing the Extension Element Classes</a>	<a href="#">page 119</a>
<a href="#">Implementing the Extension Factory</a>	<a href="#">page 125</a>
<a href="#">Registering the Extension Factory</a>	<a href="#">page 131</a>

---

## Implementing an Extension Element Base Class

---

### Overview

This subsection describes how to implement an extension element base class for the stub transport. Although it is not strictly necessary to define an extension element base class, if you have just one extension element, it is nevertheless good coding practice. Once you have defined a base class for your custom extension elements, it is relatively easy to add new extension elements as needed.

### Extension element base header

[Example 31](#) shows the header for the stub plug-in's extension element base class.

**Example 31:** *Header for the StubTransportWSDLExtensionElement Class*

```
// C++
#include <it_wsdl/wsdl_extension_element.h>
#include <it_wsdl/wsdl_port.h>

namespace IT_Transport_Stub
{
1   class StubTransportWSDLExtensionElement :
      public IT_WSDL::WSDLExtensionElement,
      public IT_Bus::XMLNode
    {
      public:
        StubTransportWSDLExtensionElement(
            IT_WSDL::WSDLExtensibleNode* the_node
        );

2       virtual const IT_Bus::QName &
        get_element_name() const;

        virtual const IT_Bus::String &
        get_target_namespace() const;

3       virtual
        IT_WSDL::WSDLExtensionFactory &
        get_extension_factory();

        virtual ~StubTransportWSDLExtensionElement();

        virtual void
```



**Example 31:** Header for the *StubTransportWSDLExtensionElement* Class

```

    read(
        const IT_Bus::QName& name,
        IT_Bus::ComplexTypeReader & reader
    ) IT_THROW_DECL((IT_Bus::DeserializationException))
    {
        throw IT_Bus::IOException("Not Supported");
    }

    virtual void
    write(
        const IT_Bus::QName& element_name,
        IT_Bus::ComplexTypeWriter & writer
    ) const IT_THROW_DECL((IT_Bus::SerializationException))
    {
        // complete
    }

    virtual void
4    write(
        IT_Bus::XMLOutputStream & stream
    ) const IT_THROW_DECL((IT_Bus::IOException));

    virtual
    IT_Bus::AnyType&
    copy(
        const IT_Bus::AnyType & rhs
    )
    {
        return *this;
    }

    protected:
5    IT_WSDL::WSDLExtensibleNode * m_wsdl_extensible_node;

    private:
        ...
};
};

```

The preceding header file can be explained as follows:

1. The extension element base class must inherit from `IT_WSDL::WSDLExtensionElement` and `IT_Bus::XMLNode`.
2. The `get_element_name()` and `get_target_namespace()` functions are inherited from the `IT_WSDL::WSDLNode` base class, by way of the `IT_WSDL::WSDLExtensionElement` class.
3. The `get_extension_factory()` element is inherited from the `IT_WSDL::WSDLExtensionElement` class.
4. The `write(XMLOutputStream)` function is inherited from the `IT_WSDL::WSDLNode` base class, by way of the `IT_WSDL::WSDLExtensionElement` class.
5. The `m_wsdl_extensible_node` is used to store a pointer to the parent node (that is, a pointer to the `WSDLExtensibleNode` instance that contains this node).

## Extension element base implementation

**Example 32** shows the implementation of the stub plug-in's extension element base class.

### **Example 32:** *Implementation of StubTransportWSDLExtensionElement*

```
// C++
#include "stub_transport_wsdl_extension_element.h"
#include "stub_transport_wsdl_extension_factory.h"

using namespace IT_Bus;
using namespace IT_WSDL;
using namespace IT_Transport_Stub;

1 StubTransportWSDLExtensionElement::StubTransportWSDLExtensionElement(
    IT_WSDL::WSDLExtensibleNode* the_node
) : m_wsdl_extensible_node(the_node)
{
    // complete
}

StubTransportWSDLExtensionElement::~StubTransportWSDLExtensionElement()
{
    // complete
}
```

**Example 32:** *Implementation of StubTransportWSDLExtensionElement*

```

WSDLExtensionFactory &
2 StubTransportWSDLExtensionElement::get_extension_factory()
{
    return StubTransportWSDLExtensionFactory::get_instance();
}

const IT_Bus::QName &
3 StubTransportWSDLExtensionElement::get_element_name() const
{
    return get_tag_name();
}

const IT_Bus::String &
4 StubTransportWSDLExtensionElement::get_target_namespace() const
{
    return XMLNode::get_target_namespace();
}

void
5 StubTransportWSDLExtensionElement::write(
    XMLOutputStream & stream
) const IT_THROW_DECL((IOException))
{
    write_start_tag(stream);
    write_end_tag(stream);
}

```

The preceding implementation class can be described as follows:

1. The sole constructor argument, `the_node`, is a pointer to the parent extensible element node (an extensible element node is a node that can contain other element nodes).
2. The `get_extension_factory()` function returns a reference to the extension factory that is responsible for creating all of the WSDL extension elements that inherit from this extension element base class.
3. The implementation of `get_tag_name()` is inherited from the `IT_Bus::XMLNode` base class. It returns the `QName` of the current element.
4. The implementation of `get_target_namespace()` simply calls the implementation from the `IT_Bus::XMLNode` base class.

5. You must implement the `write(XMLOutputStream)` function (and the `write_attributes()` function—see [“Extension element implementation” on page 121](#)), if you want your extension elements to be writeable to a file or other output stream.

**Note:** In particular, it is *essential* to implement the stream `write()` function, in order for your extension elements to function correctly with the Artix `wSDL_publish` plug-in. In response to a client query, the `wSDL_publish` plug-in returns the server’s in-memory version of the WSDL contract. If you have not implemented the stream `write()` function, the returned WSDL contract would not include your WSDL extension element.

The implementation shown here writes the element’s start tag (including any requisite namespace settings and attribute settings) and the element’s end tag. This is sufficient for simple elements with no content. On the other hand, if some of your extension elements do have content, you should override the `write()` function in that element’s sub-class.

---

## Implementing the Extension Element Classes

---

### Overview

This subsection describes how to implement the stub extension element class (there is only one extension element in the stub transport plug-in). This class must be capable of parsing the stub extension element.

---

### Stub extension element

The stub plug-in adds a single extension element to WSDL, as shown in [Example 33](#). The stub extension element name is *NamespacePrefix:address*, with a single attribute, *location*. In [Example 33](#), the *NamespacePrefix* is defined as *stub*.

#### Example 33: Sample WSDL with Stub Extension Element

```
<?xml version="1.0" encoding="UTF-8"?>
<definitions ...
  targetNamespace = ...
  xmlns      = "http://schemas.xmlsoap.org/wsdl/"
  xmlns:stub= "http://schemas.iona.com/transports/stub"
  ...
>
...
<service ... >
  <port ... >
    <stub:address
      location="local_0001"
    />
  </port>
</service>
</definitions>
```

---

### Extension element header

[Example 34](#) shows the header file for the stub extension element class.

#### Example 34: Header for the StubTransportWSDLAddress Class

```
// C++
#include "stub_transport_wsdl_extension_element.h"

namespace IT_Transport_Stub
{
1   class StubTransportWSDLAddress :
      public StubTransportWSDLExtensionElement
```

**Example 34:** *Header for the StubTransportWSDLAddress Class*

```

{
    public:

        StubTransportWSDLAddress(
            IT_WSDL::WSDLExtensibleNode* the_node
        );
        StubTransportWSDLAddress();
        virtual ~StubTransportWSDLAddress();

        IT_WSDL::WSDLExtensionElement*
        clone() const;

        virtual bool
        parse(
            const IT_Bus::XMLIterator & element_iterator,
            const IT_Bus::XMLNode & element,
            IT_WSDL::WSDLErrorHandler & error_handler
        );

        const IT_Bus::String&
2       get_location() const;

        virtual void
        set_location(
            const IT_Bus::String & location
        );

        virtual void
3       write_attributes(
            XMLOutputStream & stream
        ) const IT_THROW_DECL((IOException));

        virtual
        IT_Bus::AnyType&
        operator=(
            const IT_Bus::AnyType & rhs
        )
        {
            return *this;
        }

4       static const IT_Bus::String ELEMENT_NAME;
        static const IT_Bus::String TYPE_ATTRIBUTE_NAME;

    private:

```

**Example 34:** *Header for the StubTransportWSDLAddress Class*

```

5      IT_Bus::String m_location;
      IT_Bus::String m_target_namespace;
      ...
    };
};

```

The preceding header file can be described as follows:

1. The stub extension element inherits from the stub extension element base class, `StubTransportWSDLExtensionElement`.
2. The `get_location()` and `set_location()` functions are not inherited. They are specific to the `StubTransportWSDLAddress` class.
3. The `write_attributes()` function is inherited from the `IT_Bus::XMLNode` base class.
4. Two convenient constants are declared here: `ELEMENT_NAME` is the local part of the extension element QName, which is `address`; `TYPE_ATTRIBUTE_NAME` is the name of the attribute, `location`.
5. The `m_location` variable stores the value of the `location` attribute, (which is, essentially, all of the useful information that is contained in the address element).

## Extension element implementation

[Example 35](#) shows the implementation of the stub extension element class.

**Example 35:** *Implementation of the StubTransportWSDLAddress Class*

```

// C++
#include "stub_transport_wsdl_address.h"

#include "stub_transport_wsdl_extension_factory.h"

using namespace IT_Bus;
using namespace IT_WSDL;
using namespace IT_Transport_Stub;

1  const String StubTransportWSDLAddress::ELEMENT_NAME = "address";
   const String StubTransportWSDLAddress::TYPE_ATTRIBUTE_NAME =
      "location";

```

**Example 35:** *Implementation of the StubTransportWSDLAddress Class*

```

2 StubTransportWSDLAddress::StubTransportWSDLAddress (
    IT_WSDL::WSDLExtensibleNode* the_node
)
: StubTransportWSDLExtensionElement(the_node)
{
    // complete
}

3 StubTransportWSDLAddress::StubTransportWSDLAddress ()
: StubTransportWSDLExtensionElement(0)
{
    set_tag_name(
        StubTransportWSDLAddress::ELEMENT_NAME.c_str(),
        StubTransportWSDLExtensionFactory::SCHEMA_URL.c_str(),
        0
    );
}

StubTransportWSDLAddress::~StubTransportWSDLAddress ()
{
    // complete
}

IT_WSDL::WSDLExtensionElement*
4 StubTransportWSDLAddress::clone() const
{
    StubTransportWSDLAddress* clone =
        new StubTransportWSDLAddress();
    clone->set_location(this->get_location());
    return clone;
}

bool
5 StubTransportWSDLAddress::parse(
    const XMLIterator & element_iterator,
    const IT_Bus::XMLNode & element,
    IT_WSDL::WSDLErrorHandler & error_handler
)
{
6     XMLNode::operator =(element);

```



**Example 35:** *Implementation of the StubTransportWSDLAddress Class*

```

7     m_location = element_iterator.get_field_as_string(
        TYPE_ATTRIBUTE_NAME
    );
    return true;
}

const String&
8 StubTransportWSDLAddress::get_location() const
{
    return m_location;
}

void
StubTransportWSDLAddress::set_location(
    const String & location
)
{
    m_location = location;
}

void
9 StubTransportWSDLAddress::write_attributes(
    XMLOutputStream & stream
) const IT_THROW_DECL((IOException))
{
    XMLAttributeWriter::write(
        stream,
        "location",
        m_location
    );
}

```

The preceding class implementation can be explained as follows:

1. The `ELEMENT_NAME` and `TYPE_ATTRIBUTE_NAME` constants are defined here.
2. This form of the constructor takes a pointer to the parent extensible element. This is the form of constructor called by the stub plug-in's WSDL extension factory.
3. The default constructor sets the QName of this element by calling the `set_tag_name()` function, which is inherited from the `IT_Bus::XMLNode` class.
4. The `clone()` method makes a copy of the WSDL extension element.

5. The `parse()` function is automatically called by the Artix core as it constructs the in-memory WSDL model of the application's WSDL contract.
6. This call to `XMLNode::operator=()` copies the contents of the `element` parameter into the current element. The unusual syntax ensures that only the `XMLNode` version of the assignment operator is used (as opposed to an assignment operator defined lower down the inheritance hierarchy).
7. The call to `XMLIterator::get_field_as_string()` searches the node for the value of the `location` attribute (in this context, *field* means an attribute value).
8. The `get_location()` function can be called by other components of the stub plug-in to access the value of the `location` attribute from the `address` element.
9. In order to support writing to an output stream (as required for compatibility with the `wSDL_publish` plug-in, for example), it is necessary to implement the `write_attributes()` function.

The `XMLAttributeWriter` class is a utility class that facilitates writing XML attributes to the output stream. It defines a collection of overloaded static `write()` functions that enable you to write basic types as attributes.

The `XMLAttributeWriter::write()` function can take any of the following types as its third argument: `IT_Bus::String&`,  
`IT_Bus::Boolean`, `IT_Bus::Float`, `IT_Bus::Double`, `IT_Bus::Int`,  
`IT_Bus::Long`, `IT_Bus::Short`, `IT_Bus::UInt`, `IT_Bus::ULong`,  
`IT_Bus::UShort`, `IT_Bus::Byte`, `IT_Bus::UByte`, `IT_Bus::DateTime`,  
`IT_Bus::Decimal`, `IT_Bus::BinaryInParam`.

---

## Implementing the Extension Factory

---

### Overview

This subsection describes how to write the stub extension factory class. An extension factory must be capable of creating *all* types of extension element that belong to a specific namespace (identified by a namespace URI).

In particular, the stub extension factory must be capable of creating all WSDL extension elements belonging to the

`http://schemas.iona.com/transport/iiop_stub` namespace. There is, in fact, only one such extension element: `stubPrefix:address`.

---

### Stub extension factory header

[Example 36](#) shows the header file for the stub extension factory class.

**Example 36:** *Header for the StubTransportWSDLExtensionFactory Class*

```

// C++
#include <it_wSDL/wSDL_extension_factory.h>
#include <it_bus/bus.h>
#include "stub_transport_wSDL_extension_element.h"

namespace IT_Transport_Stub
{
1  class StubTransportWSDLExtensionFactory
    : public IT_WSDL::WSDLExtensionFactory
    {
    public:
        virtual
        IT_WSDL::WSDLExtensionElement *
        create_extension_element(
            IT_WSDL::WSDLExtensibleNode& parent,
            const IT_Bus::QName& extension_element
        ) const;

        virtual IT_Bus::AnyType *
        create_type(
            const IT_Bus::QName& extension_element
        ) const;

        virtual void
        destroy_type(
            IT_Bus::AnyType * element
        ) const;

```

**Example 36:** *Header for the StubTransportWSDLExtensionFactory Class*

```

static StubTransportWSDLExtensionFactory &
get_instance();

static StubTransportWSDLExtensionElement*
2 get_extension_element(
    const IT_WSDL::WSDLPort& wsdl_port,
    const IT_Bus::String& element_name
    );

StubTransportWSDLExtensionFactory();
virtual ~StubTransportWSDLExtensionFactory();

3 static const IT_Bus::String SCHEMA_URL;

private:
    ...
};
};

```

The preceding header file can be explained as follows:

1. The extension factory must inherit from the `IT_WSDL::WSDLExtensionFactory` base class.
2. The `get_extension_element()` function is not inherited. It is specific to the stub WSDL extension factory.
3. The `SCHEMA_URL` is a convenient string constant that stores the namespace URI for this extension factory. It is initialized to be `http://schemas.iona.com/transport/stub`.

**Stub extension factory implementation**

[Example 37](#) shows the implementation of the stub extension factory class.

**Example 37:** *Implementation of the StubTransportWSDLExtensionFactory*

```

// C++
#include "stub_transport_wsdl_address.h"
#include "stub_transport_wsdl_extension_factory.h"

using namespace IT_WSDL;
using namespace IT_Bus;
using namespace IT_Transport_Stub;

```

**Example 37:** *Implementation of the StubTransportWSDLExtensionFactory*

```

1  const String StubTransportWSDLExtensionFactory::SCHEMA_URL =
    "http://schemas.iona.com/transport/stub";

    StubTransportWSDLExtensionFactory::StubTransportWSDLExtensionFactory()
    {
        // complete
    }

    StubTransportWSDLExtensionFactory::~StubTransportWSDLExtensionFactory()
    {
        // complete
    }

    IT_Bus::AnyType *
2  StubTransportWSDLExtensionFactory::create_type(
    const QName& extension_element
    ) const
    {
        return 0;
    }

    WSDLExtensionElement *
3  StubTransportWSDLExtensionFactory::create_extension_element(
    WSDLExtensibleNode& parent,
    const QName& extension_element
    ) const
    {
        String local_part = extension_element.get_local_part();

4      if (local_part == StubTransportWSDLAddress::ELEMENT_NAME)
        {
            return new StubTransportWSDLAddress(&parent);
        }

5      return 0;
    }

    void
    StubTransportWSDLExtensionFactory::destroy_type(
        IT_Bus::AnyType * element
    ) const
    {
        delete IT_DYNAMIC_CAST(

```

**Example 37:** *Implementation of the StubTransportWSDLExtensionFactory*

```

        StubTransportWSDLExtensionElement *,
        element
    );
}

6 StubTransportWSDLExtensionFactory
  it_glob_stub_transport_wsdl_extension_factory_instance;

StubTransportWSDLExtensionFactory &
StubTransportWSDLExtensionFactory::get_instance()
{
    return
    it_glob_stub_transport_wsdl_extension_factory_instance;
}

StubTransportWSDLExtensionElement*
7 StubTransportWSDLExtensionFactory::get_extension_element(
    const WSDLPort& wsdl_port,
    const String& element_name
)
{
    StubTransportWSDLExtensionElement* extension_element = 0;

8    const WSDLExtensionElementList & port_children_nodes =
        wsdl_port.get_extension_elements();

9    WSDLExtensionElementList::const_iterator node_iter =
        port_children_nodes.begin();

    QName element_qname("", element_name, SCHEMA_URL);

    while (node_iter != port_children_nodes.end())
    {
        const QName & curr_qname =
            (*node_iter)->get_element_name();

        if (element_qname == curr_qname)
        {
            extension_element = IT_DYNAMIC_CAST(
                StubTransportWSDLExtensionElement *,
                (*node_iter)
            );
        }
        node_iter++;
    }
}

```

**Example 37:** *Implementation of the StubTransportWSDLExtensionFactory*

```

    return extension_element;
}

```

The preceding implementation class can be explained as follows:

1. This line sets the `SCHEMA_URL` to `http://schemas.iona.com/transport/stub`, which is the namespace URI that identifies this WSDL extension factory.
2. A WSDL extension factory can also be used to define new XML schema types, which can be instantiated using the `create_type()` function. Because the stub plug-in's schema does not define any new types, this function has a dummy implementation.
3. The `create_extension_element()` function is called by the Artix core while it is creating the in-memory WSDL parse tree. When the WSDL parser encounters an element that belongs to the stub plug-in's namespace URI, it delegates creation of the element to this extension factory. The `create_extension_element()` function is responsible for creating *all* of the different kinds of elements that belong to the `http://schemas.iona.com/transport/stub` namespace URI.
4. Because there is only one extension element defined by the stub plug-in (that is, `address`), it is only necessary to check if the local part of the QName equals `address` before creating a `StubTransportWSDLAddress` instance.  
In general, however, an implementation of `create_extension_element()` would typically have to compare the value of `local_part` with several different extension element names to select the right type of element.
5. A return value of 0 indicates that `create_extension_element()` could not create the requested element type.
6. This line creates a single global instance of the stub plug-in's WSDL extension factory.

**Note:** You do not necessarily have to create this factory as a global static object. Any variation of a singleton implementation pattern would do here.

7. The `get_extension_element()` function is specific to this extension factory implementation. It searches a WSDL port element, `wSDL_port`, for a sub-element with the given name, `element_name`. The transport code uses this function to extract configuration details from the WSDL port.
8. The `get_extension_elements()` function returns a list of all the sub-elements contained in the WSDL port.
9. The extension element list is modelled on the C++ Standard Template Library list type, `std::list`. Hence, you can use an iterator to search through the WSDL port's sub-elements.



---

## Registering the Extension Factory

---

### Overview

The final step is to register the stub extension factory, so that the extensions become available to the overall WSDL parse tree. Registration is performed by calling the `register_extension_factory()` function on the WSDL factory object.

### WSDL factory

The *WSDL factory* is an object of `IT_WSDL::WSDLFactory` type that maintains a registry of all WSDL extension factory classes. The following `IT_WSDL::WSDLFactory` member functions manage the extension factory registry:

```
// C++
void register_extension_factory(
    const IT_Bus::String &extension_namespace,
    const WSDLExtensionFactory &factory
);

void deregister_extension_factory(
    const IT_Bus::String &extension_namespace
);
```

### Namespace URI

Registration associates a specific namespace URI with an extension factory. While parsing a WSDL file, the WSDL factory will call on the extension factory whenever it encounters elements from this namespace.

In the case of the stub extension factory, the namespace URI is:

```
http://schemas.iona.com/transportst/stub
```

**Example**

**Example 38** shows how to register a stub extension factory with the `IT_WSDL::WSDLFactory` object. For the stub plug-in, registration is performed by the `TransportFactory` object—see [“Implementing the Transport Factory”](#) on page 183.

**Example 38:** *Registering a WSDL Extension Factory Instance*

```
// C++
...
using namespace IT_Bus;
using namespace IT_WSDL;
...
void
IT_Transport_Stub::StubTransportFactory::register_wsdl_extension
_factories(
    IT_WSDL::WSDLFactory & factory
) const
{
    factory.register_extension_factory(
        "http://schemas.iona.com/transport/stub",
        it_glob_stub_transport_wsdl_extension_factory_instance
    );
}

void
IT_Transport_Stub::StubTransportFactory::deregister_wsdl_extensi
on_factories(
    IT_WSDL::WSDLFactory & factory
) const
{
    factory.deregister_extension_factory(
        "http://schemas.iona.com/transport/stub"
    );
}
```

# Artix Transport Plug-Ins

*This chapter describes how to implement an Artix transport plug-in, which enables you to integrate Artix with any transport protocol.*

---

**In this chapter**

This chapter discusses the following topics:

<a href="#">The Artix Transport Layer</a>	<a href="#">page 134</a>
<a href="#">Transport Threading Models</a>	<a href="#">page 140</a>
<a href="#">Dispatch Policies</a>	<a href="#">page 152</a>
<a href="#">Accessing Contexts</a>	<a href="#">page 161</a>
<a href="#">Oneway Semantics</a>	<a href="#">page 165</a>
<a href="#">Stub Transport Example</a>	<a href="#">page 168</a>

---

# The Artix Transport Layer

---

## Overview

This section provides an overview of the architecture and API for the Artix transport layer.

---

## In this section

This section contains the following subsections:

<a href="#">Architecture Overview</a>	<a href="#">page 135</a>
<a href="#">Artix Transport Classes</a>	<a href="#">page 137</a>

## Architecture Overview

### Transport architecture

Figure 10 gives a high-level overview of the Artix transport architecture.

**Figure 10:** *Artix Transport Architecture*

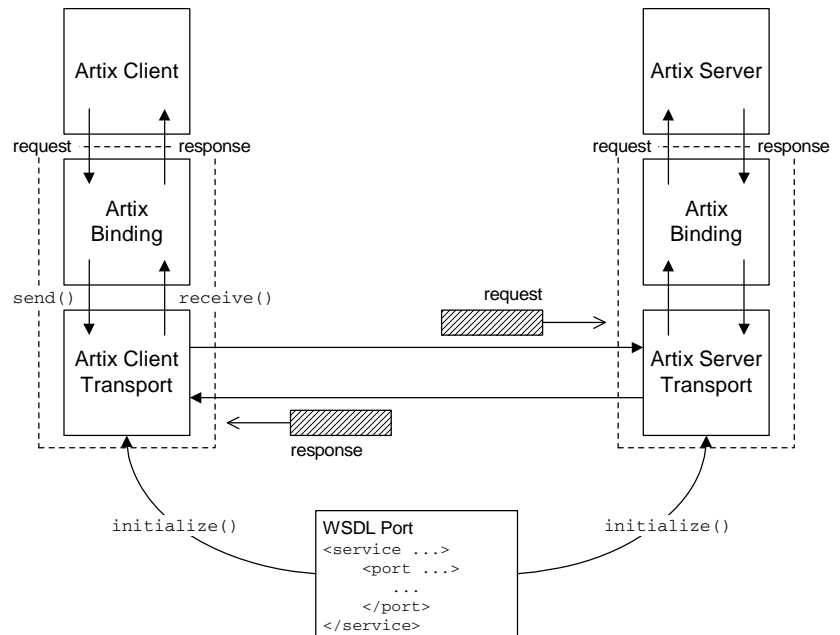

### WSDL port

The WSDL port, as shown in Figure 10, refers to the WSDL `port` element that specifies the connection parameters for this transport instance. For example, the WSDL port for a TCP/IP-based transport would specify values for the server's host and IP port.

In the general case, a WSDL port can specify connection parameters for both client and server.

---

## Client transport

A client transport is an object of `IT_Bus::ClientTransport` type, which can be implemented by an Artix plug-in developer. The main functions supported by the client transport class are, as follows:

- `initialize()`—configure the client connection (usually based on the parameters read from the WSDL port).
  - `connect()/disconnect()`—open/close a connection to the remote host.
  - `invoke()/invoke_oneway()`—send and receive messages in raw binary format.
- 

## Server transport

A server transport is an object of `IT_Bus::ServerTransport` type, which can be implemented by an Artix plug-in developer. The main functions supported by the server transport class are, as follows:

- `activate()`—begin listening for client connection attempts and incoming request messages. Typically, the implementation of this function spawns a new thread to listen for incoming messages.
- `deactivate()`—stop listening for client connection attempts and incoming request messages.
- `get_configuration()`—return a reference to the WSDL extension element that configures this transport.
- `shutdown()`—notifies the server transport that the Bus is shutting down.
- `send()`—a callback to send reply messages back to the client. This function is called, only if you select an asynchronous style of message dispatch (which is indicated by enabling the `requires stack unwind` policy).
- `run()`—for a certain combination of policies, this function contains the code that listens for incoming requests. If you select the `MESSAGING_PORT_DRIVEN` threading resources policy in combination with the `MULTI_THREADED` messaging port threading policy, the `run()` function is called concurrently by multiple messaging port threads.

## Artix Transport Classes

### Overview

Figure 11 shows an overview of the main classes that are relevant to the implementation of an Artix transport. A brief description of each of these classes is provided in this subsection.

**Figure 11:** *Overview of the Artix Transport Classes*

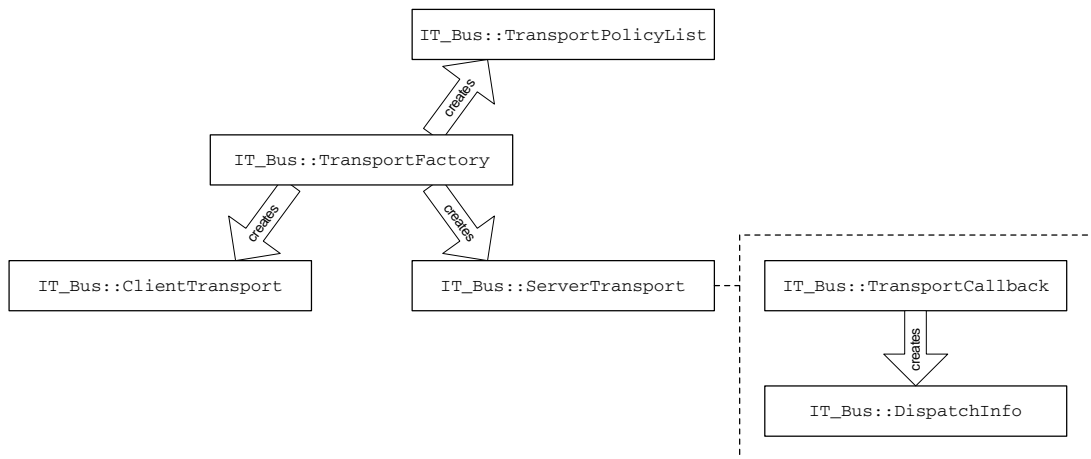

### TransportFactory Class

The `IT_Bus::TransportFactory` is responsible for creating the basic objects in a transport implementation. When implementing a transport, you must implement a class that derives from `TransportFactory` and then register an instance of the transport factory implementation with the Artix Bus.

### ClientTransport Class

For the client side of a transport, you must define and implement a class that derives from the `IT_Bus::ClientTransport` class. The client transport must be capable of opening a connection to a remote service, as well as sending and receiving binary buffers through the transport.

---

## ServerTransport Class

For the server side of a transport, you must define and implement a class that derives from the `IT_Bus::ServerTransport` class. The server transport implementation should be capable of listening for incoming request messages (in binary format) from the transport layer and dispatching these messages up the call stack.

Requests are dispatched by calling the `IT_Bus::TransportCallback::dispatch()` function.

---

## TransportCallback Class

The `IT_Bus::TransportCallback` class is provided by the Artix runtime; you do *not* need to implement this class. The most important member of `TransportCallback` is the `dispatch()` function, which the server code uses to dispatch a request message up the call stack.

The `TransportCallback` class acts as an *observer* for the `ServerTransport` class. The `TransportCallback` functions must be called from within a `ServerTransport` object as follows:

- `TransportCallback::transport_activated()`—called from within `ServerTransport::activate()`, after the transport is activated.
  - `TransportCallback::transport_deactivated()`—called from within `ServerTransport::deactivate()`, after the transport is deactivated.
  - `TransportCallback::transport_shutdown()`—called from within `ServerTransport::shutdown()`, after the transport has been shut down.
- 

## DispatchInfo Class

The `IT_Bus::DispatchInfo` class is provided by the Artix runtime. You can obtain a `DispatchInfo` object by calling the `TransportCallback::get_dispatch_context()` function. On the server side, a `DispatchInfo` object is used to encapsulate additional information about the current message.

For example, the `DispatchInfo` object is used to hold incoming and outgoing context data. You can also use the `DispatchInfo::get_correlation_id()` function to obtain an ID that lets you match incoming requests to outgoing replies.



---

**TransportPolicyList Class**

The `IT_Bus::TransportPolicyList` holds a collection of policy options that affect the semantics of the server side of the transport. You can customize the interaction between the Artix runtime and the server transport by setting the appropriate policies on a `TransportPolicyList` instance and returning this instance from the `TransportFactory::get_policies()` function.

---

# Transport Threading Models

---

## Overview

Artix provides a variety of threading models for server transports. For a relatively simple server transport implementation, you can take advantage of the messaging port thread pool, which makes it unnecessary to write the threading code yourself. Alternatively, if you need more flexibility, you can use the externally driven threading model, which allows you to implement a custom threading model.

---

## In this section

This section contains the following subsections:

<a href="#">Threading Introduction</a>	<a href="#">page 141</a>
<a href="#">MESSAGING_PORT_DRIVEN and MULTI_INSTANCE</a>	<a href="#">page 143</a>
<a href="#">MESSAGING_PORT_DRIVEN and MULTI_THREADED</a>	<a href="#">page 145</a>
<a href="#">MESSAGING_PORT_DRIVEN and SINGLE_THREADED</a>	<a href="#">page 148</a>
<a href="#">EXTERNALLY_DRIVEN</a>	<a href="#">page 150</a>

---

# Threading Introduction

---

## Overview

The server transport threading model is selected by setting threading policies on an `IT_Bus::TransportPolicyList` object. This section provides a brief overview of the various threading policy combinations. The chosen threading policy combination affects the transport in two ways:

- It dictates a particular programming model for the server transport and
- It regulates the interaction between the Artix runtime and the server transport.

---

## Threading resources policy

The threading resources policy is used to tell the Artix runtime where the server transport's threading resources must come from:

- `MESSAGING_PORT_DRIVEN` policy value—the threads used to read incoming request messages are supplied from the messaging port thread pool. This policy setting can be combined with one of the following messaging port threading policies:
  - ◆ `MULTI_INSTANCE`,
  - ◆ `MULTI_THREADED`,
  - ◆ `SINGLE_THREADED`.
- `EXTERNALLY_DRIVEN` policy value—the reader threads are either created by the server transport itself or provided from some other external source.

---

## Messaging port threading model policy

If you have selected the `MESSAGING_PORT_DRIVEN` threading resources policy, you can combine it with a messaging port threading model policy. The following policy values are supported:

- `MULTI_INSTANCE` policy value—the Artix runtime creates multiple instances of the `ServerTransport` class and each instance consumes a single thread from the messaging port thread pool.
- `MULTI_THREADED` policy value—the Artix runtime creates a single instance of the `ServerTransport` class and this single instance consumes multiple threads from the messaging port thread pool.

- `SINGLE_THREADED` policy value—the Artix runtime creates a single instance of the `ServerTransport` class and this instance consumes a single thread from the messaging port thread pool.
- 

### Setting the server transport threading policies

To set the server threading policies, create an `IT_Bus::TransportPolicyList` instance, initialize it with the relevant policy values, and return the policy list from the `TransportFactory::get_policies()` function.

When the Artix runtime is about to activate a service, it calls the `get_policies()` function to discover what kind of policies should govern the server transport. This includes the settings for the threading model.

## MESSAGING\_PORT\_DRIVEN and MULTI\_INSTANCE

### Overview

By combining the `MESSAGING_PORT_DRIVEN` and `MULTI_INSTANCE` policy values, you obtain the threading model shown in [Figure 12](#). When the service is activated, Artix creates multiple `ServerTransport` instances to service the incoming requests. Each of the `ServerTransport` instances consumes a thread from the messaging port thread pool.

The implementation of the `activate()` function incorporates a while loop which continuously reads request messages from the transport layer and dispatches these requests to a `TransportCallback` object. It is this blocked `activate()` function which consumes a messaging port thread.

**Figure 12:** *MESSAGING\_PORT\_DRIVEN and MULTI\_INSTANCE Threading Model*

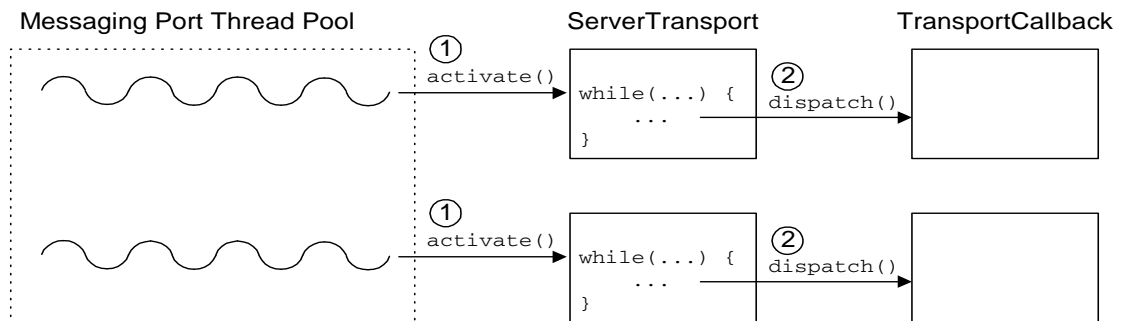

### How it works

The `MESSAGING_PORT_DRIVEN` and `MULTI_INSTANCE` threading model shown in [Figure 12](#) works as follows:

Stage	Description
1	Each of the threads in the messaging port thread pool calls <code>activate()</code> on a separate <code>IT_Bus::ServerTransport</code> instance. The <code>activate()</code> function remains blocked for as long as the service is active (the <code>activate()</code> implementation typically contains a while loop).

Stage	Description
2	Each of the <code>ServerTransport</code> objects calls <code>dispatch()</code> on a separate <code>IT_Bus::TransportCallback</code> instance.

## Setting the policies

To set the server threading policies, create an `IT_Bus::TransportPolicyList` instance, initialize it with the relevant policy values, and return the policy list from the `TransportFactory::get_policies()` function.

[Example 39](#) shows how to set the `MESSAGING_PORT_DRIVEN` and `MULTI_INSTANCE` policy values.

**Example 39:** *Setting Policies for `MESSAGING_PORT_DRIVEN` and `MULTI_INSTANCE` Threading Model*

```
// C++
void
TransportFactoryImpl::initialize(Bus_ptr bus)
{
    m_transport_policylist =
        bus->get_pdk_bus()->create_transport_policy_list();
    m_transport_policylist->set_policy_threading_resources(
        IT_Bus::MESSAGING_PORT_DRIVEN
    );
    m_transport_policylist->set_policy_messaging_port_threading(
        IT_Bus::MULTI_INSTANCE
    );
}

const TransportPolicyList*
TransportFactoryImpl::get_policies()
{
    return m_transport_policylist;
}
```

## Configuring the thread pool

To configure the thread pool for a transport that uses a combination of the `MESSAGING_PORT_DRIVEN` and `MULTI_INSTANCE` policies, set the following variable in the Artix configuration file:

```
policy:messaging_transport:min_threads
```

This variable specifies the number of threads in the messaging port's thread pool, when the multi-instance policy is in effect. The default is 1.

## MESSAGING\_PORT\_DRIVEN and MULTI\_THREADED

### Overview

By combining the `MESSAGING_PORT_DRIVEN` and `MULTI_THREADED` policy values, you obtain the threading model shown in [Figure 13](#). When the service is activated, Artix creates a *single* `ServerTransport` instance to service the incoming requests. The `activate()` function is responsible for initializing the transport and the `run()` function, which is called concurrently by multiple threads, is responsible for processing incoming requests.

The implementation of the `run()` function incorporates a while loop which continuously reads request messages from the transport layer and dispatches these requests to the `TransportCallback` object.

**Figure 13:** *MESSAGING\_PORT\_DRIVEN and MULTI\_THREADED Threading Model*

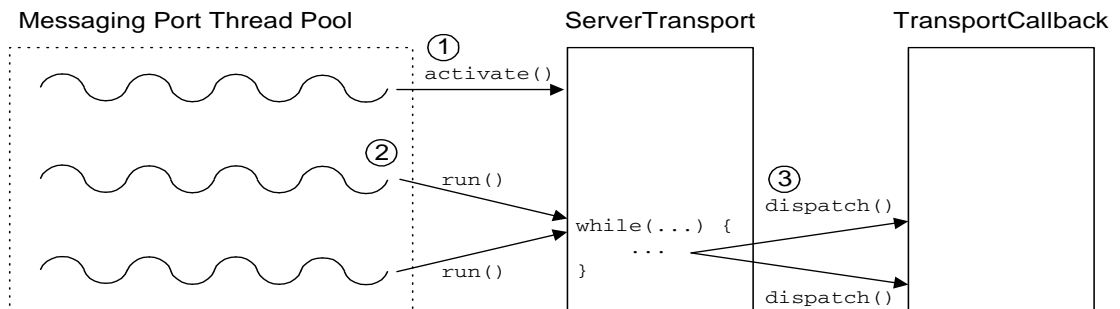

### How it works

The `MESSAGING_PORT_DRIVEN` and `MULTI_THREADED` threading model shown in [Figure 13](#) works as follows:

Stage	Description
1	A thread from the messaging port thread pool calls <code>activate()</code> on the sole <code>IT_Bus::ServerTransport</code> instance. The <code>activate()</code> function puts the transport layer into a state where it is ready to receive request messages, but the function does not process any messages and returns immediately.

Stage	Description
2	A number of threads from the thread pool call <code>run()</code> on the sole <code>IT_Bus::ServerTransport</code> instance. The <code>run()</code> function is responsible for reading request messages from the transport and dispatching them to the <code>TransportCallback</code> object. Hence, the calls to <code>run()</code> remain blocked for as long as the service is active.
3	Within each of the concurrent <code>run()</code> calls, the implementation code calls <code>dispatch()</code> on the <code>IT_Bus::TransportCallback</code> instance whenever a request message is received on the transport.

## Setting the policies

To set the server threading policies, create an `IT_Bus::TransportPolicyList` instance, initialize it with the relevant policy values, and return the policy list from the `TransportFactory::get_policies()` function.

[Example 40](#) shows how to set the `MESSAGING_PORT_DRIVEN` and `MULTI_THREADED` policy values.

**Example 40:** *Setting Policies for `MESSAGING_PORT_DRIVEN` and `MULTI_THREADED` Threading Model*

```
// C++
void
TransportFactoryImpl::initialize(Bus_ptr bus)
{
    m_transport_policylist =
        bus->get_pdk_bus()->create_transport_policy_list();
    m_transport_policylist->set_policy_threading_resources(
        IT_Bus::MESSAGING_PORT_DRIVEN
    );
    m_transport_policylist->set_policy_messaging_port_threading(
        IT_Bus::MULTI_THREADED
    );
}

const TransportPolicyList*
TransportFactoryImpl::get_policies()
{
    return m_transport_policylist;
}
```



---

**Thread safety**

When you use the `MULTI_THREADED` policy value, there is only a single instance of the `ServerTransport`, but the instance's `run()` function is called concurrently from multiple threads. *It follows that you must take care to make the implementation of `run()` completely thread-safe.*

For example, member variables of the `ServerTransport` class must be protected by a mutex lock whenever they are accessed from within the `run()` function.

---

**Configuring the thread pool**

To configure the thread pool for a transport that uses a combination of the `MESSAGING_PORT_DRIVEN` and `MULTI_THREADED` policies, set the following variable in the Artix configuration file:

```
policy:messaging_transport:concurrency
```

This variable specifies the number of threads in the messaging port's thread pool, when the multi-threaded policy is in effect. The default is 1.

# MESSAGING\_PORT\_DRIVEN and SINGLE\_THREADED

## Overview

By combining the `MESSAGING_PORT_DRIVEN` and `SINGLE_THREADED` policy values, you obtain the threading model shown in [Figure 14](#). When the service is activated, Artix creates a single `ServerTransport` instance to service the incoming requests. The `ServerTransport` instance consumes a single thread from the messaging port thread pool.

The implementation of the `activate()` function incorporates a while loop which continuously reads request messages from the transport layer and dispatches these requests to the `TransportCallback` object.

**Figure 14:** *MESSAGING\_PORT\_DRIVEN and SINGLE\_THREADED Threading Model*

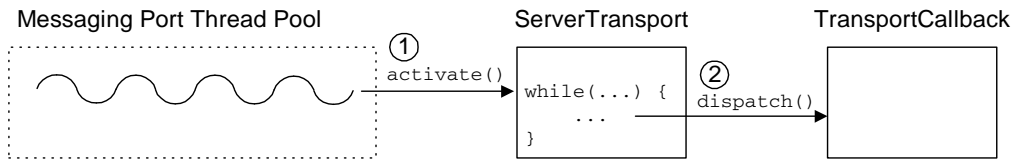

## How it works

The `MESSAGING_PORT_DRIVEN` and `SINGLE_THREADED` threading model shown in [Figure 14](#) works as follows

Stage	Description
1	A single thread in the messaging port thread pool calls <code>activate()</code> on a single <code>IT_Bus::ServerTransport</code> instance. The <code>activate()</code> function remains blocked for as long as the service is active (the <code>activate()</code> implementation typically contains a while loop).
2	The <code>ServerTransport</code> object calls <code>dispatch()</code> on the <code>IT_Bus::TransportCallback</code> instance.

## Setting the policies

To set the server threading policies, create an `IT_Bus::TransportPolicyList` instance, initialize it with the relevant policy values, and return the policy list from the `TransportFactory::get_policies()` function.

[Example 41](#) shows how to set the `MESSAGING_PORT_DRIVEN` and `SINGLE_THREADED` policy values.

**Example 41:** *Setting Policies for `MESSAGING_PORT_DRIVEN` and `SINGLE_THREADED` Threading Model*

```
// C++
void
TransportFactoryImpl::initialize(Bus_ptr bus)
{
    m_transport_policylist =
        bus->get_pdk_bus()->create_transport_policy_list();
    m_transport_policylist->set_policy_threading_resources(
        IT_Bus::MESSAGING_PORT_DRIVEN
    );
    m_transport_policylist->set_policy_messaging_port_threading(
        IT_Bus::SINGLE_THREADED
    );
}

const TransportPolicyList*
TransportFactoryImpl::get_policies()
{
    return m_transport_policylist;
}
```

## EXTERNALLY\_DRIVEN

### Overview

By selecting the `EXTERNALLY_DRIVEN` policy value, you obtain the threading model shown in [Figure 15](#). When the service is activated, Artix creates a single `ServerTransport` instance to service the incoming requests. The `ServerTransport` instance does *not* consume any threads from the messaging port thread pool. That is, the call to `activate()` must be non-blocking.

The essence of the `EXTERNALLY_DRIVEN` thread model is that it does not consume any messaging port threads. This model is useful if you use a transport library that has its own threading capabilities.

**Figure 15:** *EXTERNALLY\_DRIVEN* Threading Model

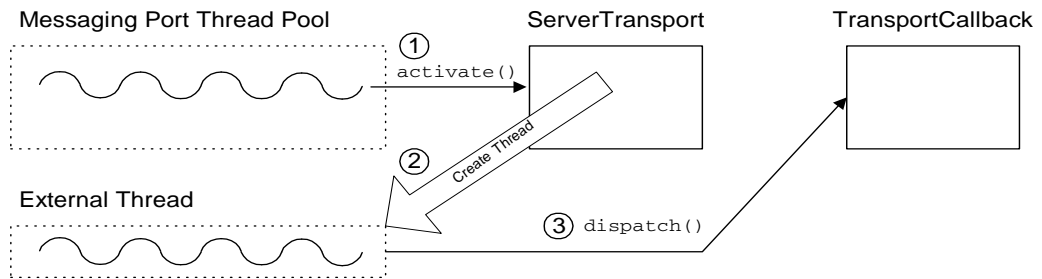

### How it works

The `EXTERNALLY_DRIVEN` threading model shown in [Figure 15](#) works as follows

Stage	Description
1	A single thread in the messaging port thread pool calls <code>activate()</code> on an <code>IT_Bus::ServerTransport</code> instance. The <code>activate()</code> function puts the transport layer into a state where it is ready to receive request messages, but it does not process any messages.

Stage	Description
2	<p>Before returning, the <code>activate()</code> function either obtains a thread from an external source or creates a new thread to process the incoming request messages.</p> <p>The request processing code could be put into a private member function of <code>ServerTransport</code> or it could belong to a different object altogether.</p>
3	<p>The request processing code, which is running in the external thread, calls <code>dispatch()</code> on the <code>IT_Bus::TransportCallback</code> instance.</p>

## Setting the policies

To set the server threading policies, create an `IT_Bus::TransportPolicyList` instance, initialize it with the relevant policy values, and return the policy list from the `TransportFactory::get_policies()` function.

[Example 42](#) shows how to set the `EXTERNALLY_DRIVEN` policy value.

### **Example 42:** *Setting Policies for EXTERNALLY\_DRIVEN Threading Model*

```
// C++
void
TransportFactoryImpl::initialize(Bus_ptr bus)
{
    m_transport_policylist =
        bus->get_pdk_bus()->create_transport_policy_list();
    m_transport_policylist->set_policy_threading_resources(
        IT_Bus::EXTERNALLY_DRIVEN
    );
}

const TransportPolicyList*
TransportFactoryImpl::get_policies()
{
    return m_transport_policylist;
}
```

---

# Dispatch Policies

## Overview

---

Dispatching refers to the stage just after the server transport obtains the request message in the form of a raw buffer. The server transport calls the `dispatch()` function to pass the request message up to the next layer in the stack, where it is processed and ultimately routed to the appropriate servant object.

The dispatch policies enable you to control the degree to which dispatching is synchronized with the transport layer. Broadly speaking, the two main options are synchronous call semantics (RPC-style dispatch) or asynchronous call semantics (messaging-style dispatch).

## In this section

---

This section contains the following subsections:

<a href="#">Dispatch Policy Overview</a>	<a href="#">page 153</a>
<a href="#">RPC-Style Dispatch</a>	<a href="#">page 155</a>
<a href="#">Messaging-Style Dispatch</a>	<a href="#">page 158</a>

---

## Dispatch Policy Overview

---

### Overview

On the server side, the manner in which a request message is dispatched to the upper layers of an application can be influenced by a number of policies, as follows:

- [Stack unwind policy](#).
- [Asynchronous dispatch policy](#).

---

### Stack unwind policy

The stack unwind policy can be set or read from a `TransportPolicyList` object using the following API functions:

```
// C++
namespace IT_Bus {
class IT_BUS_API TransportPolicyList
{
public:
...
virtual void
set_policy_requires_stack_unwind(const bool policy) = 0;

virtual const bool
get_policy_requires_stack_unwind() const = 0;
};
```

The stack unwind policy selects between an RPC-style dispatch and a messaging-style dispatch.

If the stack unwind policy is `true`, you must call the `DispatchInfo::provide_response_buffer()` function to provide a reply buffer reference and the `TransportCallback::dispatch()` function blocks until the reply buffer is written.

If the stack unwind policy is `false`, you must call the `TransportCallback::dispatch()` function to dispatch a request buffer. The reply buffer is passed back to the `ServerTransport` through a callback on the `ServerTransport::send()` function. In this case also, the `dispatch()` function blocks until the reply buffer is written.

The default is `false`.

## Asynchronous dispatch policy

The asynchronous dispatch policy can be set on a per-request basis and is set by passing a boolean value into the optional parameter of the `TransportCallback::dispatch()` function, which has the following signature:

```
// C++
namespace IT_Bus {
class IT_BUS_API TransportCallback
{
public:
...
virtual void
dispatch(
    BinaryBuffer& request_message,
    DispatchInfo& dispatch_context,
    bool          dispatch_asynchronously_if_possible = 0
) = 0;
};
```

The asynchronous dispatch policy is an optimization that enables you to decouple the reader thread from the dispatch processing.

If the asynchronous dispatch policy is `true`, the `dispatch()` function returns immediately after adding the request message to a work queue.

If the asynchronous dispatch policy is `false`, the `dispatch()` function remains blocked until the dispatch processing is complete.

**Note:** As of Artix 3.0.2, the asynchronous dispatch policy has *not* yet been implemented. That is, the `dispatch()` function always blocks. The non-blocking functionality will be implemented in a later release.



## RPC-Style Dispatch

### Overview

Some implementations of a server transport could be layered over a Remote Procedure Call (RPC) transport infrastructure. For this kind of transport, it is more convenient if the upcall blocks until the reply buffer becomes available (synchronous invocation). [Figure 16](#) shows an overview of an RPC-style dispatch call.

**Figure 16:** *Overview of RPC-Style Dispatch*

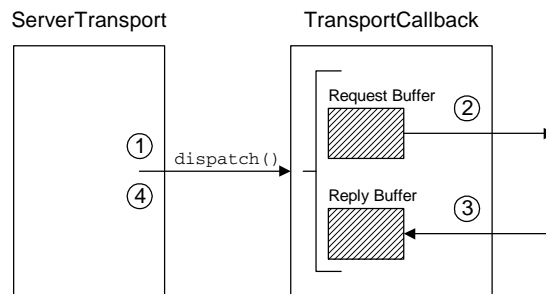

### Dispatch steps

The stages shown in [Figure 16](#) can be described as follows:

Stage	Description
1	The server transport code calls <code>dispatch()</code> on the <code>TransportCallback</code> object, passing in a reference to the request buffer.
2	The <code>TransportCallback</code> object processes the request message, resulting in an upcall to the relevant servant object.
3	After processing the request, the <code>TransportCallback</code> writes the reply data into the reply buffer. <b>Note:</b> The reply buffer must be supplied to the <code>TransportCallback</code> object in advance, using the <code>DispatchInfo::provide_response_buffer()</code> function. For details, see <a href="#">Example 44 on page 157</a> .

Stage	Description
4	The <code>dispatch()</code> call remains blocked until the reply buffer is written. After <code>dispatch()</code> returns, therefore, the reply buffer is available and ready to be sent back to the client.

### Setting the requisite policies

To set the transport policies, create an `IT_Bus::TransportPolicyList` instance, initialize it with the relevant policy values, and then return the policy list from the `TransportFactory::get_policies()` function. [Example 43](#) shows how to implement a transport factory with the policies required for RPC-style dispatch.

#### Example 43: *Setting Policies for RPC-Style Dispatch*

```
// C++
void
TransportFactoryImpl::initialize(Bus_ptr bus)
{
    m_transport_policylist =
        bus->get_pdk_bus()->create_transport_policy_list();
    m_transport_policylist->set_policy_requires_stack_unwind(
        true
    );
}

const TransportPolicyList*
TransportFactoryImpl::get_policies()
{
    return m_transport_policylist;
}
```

### Implementation example

The code fragment in [Example 44](#) shows how to make an upcall into the Artix application using RPC-style dispatch. This code fragment could appear in the body of the `ServerTransport::activate()` function, in the body of the

`ServerTransport::run()` function, or in a completely different object, depending on the type of threading model that is used (see [“Transport Threading Models”](#) on page 140).

**Example 44:** *Making an Upcall Using RPC-Style Dispatch*

```
// C++
DispatchInfo& dispatch_context =
    m_callback->get_dispatch_context();

dispatch_context.provide_response_buffer(
    vvReceiveBuffer
);

m_callback->dispatch(
    vvSendBuffer,
    dispatch_context
);

// At this point, vvReceiveBuffer contains the reply message.
```

## Messaging-Style Dispatch

### Overview

The default style of dispatching used by the Artix server transport is *messaging-style dispatch*, which is suitable for message-oriented transports such as the MQ-Series transport. For this kind of transport, the upcall returns as soon as it has dispatched the request buffer. The reply buffer is returned asynchronously, through a callback on the `ServerTransport::send()` function. [Figure 17](#) shows an overview of a messaging-style dispatch call.

**Figure 17:** Overview of Messaging-Style Dispatch

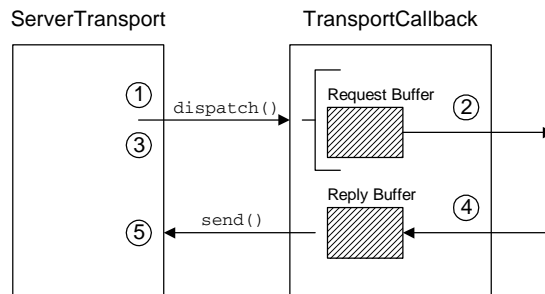

### Dispatch steps

The stages shown in [Figure 17](#) can be described as follows:

Stage	Description
1	The server transport code calls <code>dispatch()</code> on the <code>TransportCallback</code> object, passing in a reference to the request buffer.
2	The <code>TransportCallback</code> object processes the request message, resulting in an upcall to the relevant servant object.
3	The <code>dispatch()</code> call returns directly after dispatching the request message.
4	After processing the request, the <code>TransportCallback</code> writes the reply data into the reply buffer.

Stage	Description
5	The Artix runtime calls <code>send()</code> on the <code>ServerTransport</code> object, passing in a reference to the reply buffer.

### Setting the requisite policies

Normally, there is no need to set transport policies explicitly for messaging-style dispatch, because it is the default. If you do set some transport policies, however, you must be sure that the value of the *requires stack unwind policy* is `false` (the default).

### Implementation example

The code fragment in [Example 45](#) shows how to make an upcall into the Artix application using messaging-style dispatch. This code fragment could appear in the body of the `ServerTransport::activate()` function, in the body of the `ServerTransport::run()` function, or in a completely different object, depending on the type of threading model that is used (see [“Transport Threading Models”](#) on page 140).

#### **Example 45:** *Making an Upcall Using Messaging-Style Dispatch*

```
// C++
DispatchInfo& dispatch_context =
    m_callback->get_dispatch_context();

m_callback->dispatch(
    vvSendBuffer,
    dispatch_context
);

// At this point, vvReceiveBuffer contains the reply message.
```

In addition to dispatching the request buffer, you must implement the `ServerTransport::send()` function to receive the callback containing the reply buffer. [Example 46](#) shows an outline implementation of the `send()` function, which is suitable for message-style dispatch.

**Example 46:** *Implementation of `send()` for Message-Style Dispatch*

```
// C++
void
ServerTransportImpl::send(
    BinaryBuffer& reply_message,
    DispatchInfo& dispatch_context
)
{
    // Send the reply_message over the transport layer
    // back to the client.
    ... // (transport-specific details)
}
```

---

# Accessing Contexts

## Overview

Contexts are an Artix mechanism that enables application code to communicate with plug-ins. Contexts are typically used by transports for the following purposes:

- Setting connection parameters (for example, timeouts).
- Sending data in message headers (either as part of a request message or a reply message).

This section describes how to access and use contexts from within a transport implementation.

**Note:** Although Artix contexts are accessible from the transport, in many cases it is more appropriate to access contexts from within an interceptor. The use of interceptors makes your code more modular: you can load individual interceptors independently of the transport.

## Accessing contexts on the client side

The following extract from the `IT_Bus::ClientTransport` class shows how you can access Artix contexts from the `connect()`, `invoke_oneway()`, and `invoke()` functions.

```
// C++
namespace IT_Bus
{
    class IT_BUS_API ClientTransport
    {
    public:
        virtual void
        connect(
            ContextContainer* out_context_container
        ) = 0;
        ...
        virtual void
        invoke_oneway(
            const IT_WSDL::WSDLOperation& wsdl_operation,
            const BinaryBuffer& request_buffer,
            ContextContainer* out_container,
            ContextContainer* in_container
        ) = 0;
    };
}
```

```

virtual void
invoke(
    const IT_WSDL::WSDLOperation& wsdl_operation,
    const BinaryBuffer&           request_buffer,
    BinaryBuffer&                 response_buffer,
    ContextContainer*            out_container,
    ContextContainer*            in_container
    ) = 0;
    ...
};
};

```

In each of these functions, the contexts are used as follows:

- `connect()` function—the outgoing context container could contain settings that influence the transport connection (for example, connection timeouts). You can define your own context type specifically for this purpose.
- `invoke_oneway()` function—contexts can be used to send and receive header information across a transport protocol, as follows:
  - ♦ If there is outgoing data to send in a header, the transport implementation reads it from the relevant outgoing context (obtained from `out_container`) and inserts it into a request message header.
  - ♦ If there is incoming data to receive from a header, the transport implementation extracts it from the reply message and writes it into the relevant incoming context (obtained from `in_container`).

**Note:** Incoming reply contexts (read from incoming reply messages) are supported, even though this is a oneway WSDL operation. Oneway operations are *not* necessarily implemented as oneways by the transport layer. Sometimes, it is necessary to extract context data from reply messages, even for oneway operations.

- `invoke()` function—both outgoing contexts and incoming contexts are available, just as for the `invoke_oneway()` function.



### Accessing contexts with RPC-style dispatch

On the server side, incoming contexts and outgoing contexts are accessible through the current `IT_Bus::DispatchInfo` object. For example, the code for accessing contexts within an RPC-style dispatch would have the following general outline:

```
// C++
DispatchInfo& dispatch_context =
    m_callback->get_dispatch_context();

dispatch_context.provide_response_buffer(
    vvReceiveBuffer
);

ContextContainer& incoming_container =
    dispatch_context.get_incoming_context_container();

// Process each incoming context as follows:
// 1. Extract the relevant header data from the incoming request.
// 2. Obtain the relevant context instance from the
//    incoming_container.
// 3. Populate the context instance with the header data.

m_callback->dispatch(
    vvSendBuffer,
    dispatch_context
);

ContextContainer& outgoing_container =
    dispatch_context.get_outgoing_context_container();

// Process each outgoing context as follows:
// 1. Obtain the relevant context instance from the
//    outgoing_container.
// 2. Read the context data from the context instance.
// 3. Marshal the context data into an outgoing reply header.
```

### Accessing contexts with messaging-style dispatch

With messaging-style dispatch, there are two different points in the code where you access contexts. Firstly, to access incoming contexts, you need to insert some code before the `TransportCallback::dispatch()` call, as follows:

```
// C++
DispatchInfo& dispatch_context =
    m_callback->get_dispatch_context();
```

```

dispatch_context.provide_response_buffer(
    vvReceiveBuffer
);

ContextContainer& incoming_container =
    dispatch_context.get_incoming_context_container();

// Process each incoming context as follows:
// 1. Extract the relevant header data from the incoming request.
// 2. Obtain the relevant context instance from the
//    incoming_container.
// 3. Populate the context instance with the header data.

m_callback->dispatch(
    vvSendBuffer,
    dispatch_context
);

```

Next, to access outgoing contexts, you need to insert some code into the `ServerTransport::send()` function, as follows:

```

// C++
void
ServerTransportImpl::send(
    BinaryBuffer& reply_message,
    DispatchInfo& dispatch_context
)
{
    ...
    ContextContainer& outgoing_container =
        dispatch_context.get_outgoing_context_container();

    // Process each outgoing context as follows:
    // 1. Obtain the relevant context instance from the
    //    outgoing_container.
    // 1. Read the context data from the context instance.
    // 3. Marshal the context data into an outgoing reply header.
    ...
}

```

---

# Oneway Semantics

## Overview

WSDL syntax allows you to define two different kinds of operations:

- *Normal operations*—which include one or more output messages.
- *Oneway operations*—which include *only* input messages.

In general, the remote invocation of a oneway operation can be optimized so that it consists only of a request message; there is no need to wait for a reply message, because no data is expected in the reply. This is a valuable optimization, which is supported by Artix.

---

## Oneway semantics on the client side

When it comes to implementing oneway semantics on a specific transport, however, there can be a mismatch between the WSDL notion of a oneway and the semantics supported by the underlying transport protocol. For example, the HTTP protocol requires that you must always send an acknowledgment reply (HTTP 202 OK reply), even if there is no reply data.

To give you sufficient flexibility to implement oneways, therefore, the `ClientTransport` class requires you to implement separate functions for handling normal operations and oneway operations, as follows:

- `ClientTransport::invoke()` function—called when the WSDL operation includes one or more output messages.
  - `ClientTransport::invoke_oneway()` function—called when the WSDL operation includes only input messages.
- 

## Oneway semantics with RPC-style dispatch

Within the section of code that implements an RPC-style dispatch on the server side, you can check whether a WSDL operation is oneway by calling the `DispatchInfo::is_oneway()` function. If the operation is oneway, you should handle it in the appropriate way for the particular transport protocol.

For example, the code for performing an RPC-style dispatch would have the following general outline:

```
// C++
DispatchInfo& dispatch_context =
    m_callback->get_dispatch_context();

dispatch_context.provide_response_buffer(
```

```

        vvReceiveBuffer
    );

    m_callback->dispatch(
        vvSendBuffer,
        dispatch_context
    );

    if (! dispatch_context.is_oneway() ) {
        // Normal (two-way) WSDL operation

        // Use transport to send vvReceiveBuffer reply to client.
    }
    else {
        // Oneway WSDL operation
        // (vvReceiveBuffer is empty in this case)

        // HTTP protocol example: send an acknowledgment.

        // MQ-Series example: do not send any reply.
    }
}

```

### Oneway semantics with messaging-style dispatch

Within the implementation of the `IT_Bus::ServerTransport::send()` function (which is responsible for sending replies back to the client), you can check whether a WSDL operation is oneway by calling the `DispatchInfo::is_oneway()` function. If the operation is oneway, you should handle it in the appropriate way for the particular transport protocol.

For example, an implementation of `ServerTransport::send()` would have the following general outline:

```

// C++
void
ServerTransportImpl::send(
    BinaryBuffer& reply_message,
    DispatchInfo& dispatch_context
)
{
    if (! dispatch_context.is_oneway()) {
        // Normal (two-way) WSDL operation

        // Use transport to send reply_message back to client.
    }
    else {
        // Oneway WSDL operation
    }
}

```

```
    // HTTP protocol example: send an acknowledgment
    //                               before returning.

    // MQ-Series example: return immediately.
}
}
```

---

# Stub Transport Example

---

## Overview

The stub transport is a very simple transport that facilitates communication between a client and a server that are colocated in the same process. The client transport object holds a pointer that points directly at the server transport object. When the client has a message to send to the server, it simply invokes a dispatch function directly on the server transport object.

For this transport to work, the client and server *must* be colocated. This transport is potentially useful as a diagnostic tool: it enables you to send messages through the binding layers, without doing any significant work at the transport layer.

---

## In this section

This section contains the following subsections:

<a href="#">Implementing the Client Transport</a>	<a href="#">page 169</a>
<a href="#">Implementing the Server Transport</a>	<a href="#">page 176</a>
<a href="#">Implementing the Transport Factory</a>	<a href="#">page 183</a>
<a href="#">Registering and Packaging the Transport</a>	<a href="#">page 190</a>

---

## Implementing the Client Transport

---

### Overview

This subsection describes how to make a custom implementation of the `IT_Bus::ClientTransport` class, using the stub client transport as an example. The purpose of the client transport class is to manage connections and send/receive messages in binary format.

---

### Sequence of call

Artix calls back on the client transport functions in the following sequence:

1. `initialize()`—called once, to configure the port.
  2. `connect()`—called once, to establish a connection to the remote host. The `connect()` function should be non-blocking.
  3. `invoke()/invoke_oneway()`—called for each WSDL operation invocation, depending on whether it is a normal operation or a oneway operation.
  4. `disconnect()`—called once, to close the connection to the remote host.
- 

### Client transport header

[Example 47](#) shows the header file for the stub plug-in's client transport class.

#### **Example 47:** *Header for the StubClientTransport Class*

```

// C++
#include <it_bus_sys/bus_context.h>
#include <it_bus_pdk/messaging_transport.h>
#include "stub_transport_factory.h"
#include "stub_transport_wsdl_address.h"

namespace IT_Transport_Stub
{
1   class StubClientTransport : public IT_Bus::ClientTransport
    {
        public:
2       StubClientTransport(
            ServerTransportMap & server_transport_map
        );
        virtual ~StubClientTransport();
3       virtual void
            initialize(const IT_WSDL::WSDLPort& Configuration);
    }

```

**Example 47:** *Header for the StubClientTransport Class*

```

virtual IT_WSDL::WSDLExtensionElement&
get_configuration();

virtual void
connect(IT_Bus::ContextContainer* out_context_container);

virtual void disconnect();

virtual void
invoke_oneway(
    const IT_WSDL::WSDLOperation& wsdl_operation,
    const IT_Bus::BinaryBuffer& request_buffer,
    IT_Bus::ContextContainer* out_container,
    IT_Bus::ContextContainer* in_container
);

virtual void
invoke(
    const IT_WSDL::WSDLOperation& wsdl_operation,
    const IT_Bus::BinaryBuffer& request_buffer,
    IT_Bus::BinaryBuffer& response_buffer,
    IT_Bus::ContextContainer* out_container,
    IT_Bus::ContextContainer* in_container
);

protected:
4   ServerTransportMap & m_server_transport_map;
5   StubServerTransport * m_server_transport;
6   StubTransportWSDLAddress * m_address_element;
7   IT_Bus::BinaryBuffer m_received;

private:
virtual void send(
    const IT_WSDL::WSDLOperation& wsdl_operation,
    const IT_Bus::BinaryBuffer& vvSendBuffer,
    IT_Bus::ContextContainer* out_context_container
);

virtual void receive(
    const IT_WSDL::WSDLOperation& wsdl_operation,
    IT_Bus::BinaryBuffer& vvReceiveBuffer,
    IT_Bus::ContextContainer* in_context_container
);
};
};

```



The preceding transport class header can be explained as follows:

1. The tunnel client transport class must inherit from `IT_Bus::ClientTransport`.
2. The `IT_Transport_Stub::ServerTransportMap` type is a typedef of `IT_Bus::StringMap<StubServerTransport *>`, defined in the stub plug-in's transport factory header. The `ServerTransportMap` class is a hash table that uses a string as the key to retrieve a server transport instance. This hash table is the discovery mechanism used by the stub plug-in to find a colocated server transport instance.
3. The following functions, `initialize()`, `get_configuration()`, `connect()`, `disconnect()`, `send()`, and `receive()`, are all inherited from the `IT_Bus::ClientTransport` base class.
4. The `m_server_transport_map` variable stores a reference to the `ServerTransportMap` instance passed into the constructor.
5. The `m_server_transport` variable stores a pointer to the target server transport instance.
6. The `m_address_element` variable stores a pointer to the `stub:address` WSDL element that defines the location of the server transport.
7. The `m_received` binary buffer is used to store received messages temporarily.

## Client transport implementation

[Example 48](#) shows the implementation of the client transport class.

### **Example 48:** *Implementation of the StubClientTransport Class*

```
// C++
#include "stub_client_transport.h"
#include "stub_transport_wsdl_extension_factory.h"
#include "stub_server_transport.h"

using namespace IT_Bus;
using namespace IT_WSDL;

IT_Transport_Stub::StubClientTransport::StubClientTransport (
    ServerTransportMap & server_transport_map
)
: m_server_transport_map(server_transport_map)
{
    m_server_transport = 0;
}
```

**Example 48:** *Implementation of the StubClientTransport Class*

```

        m_address_element = 0;

    }

    IT_Transport_Stub::StubClientTransport::~StubClientTransport()
    {
    }

    void
1  IT_Transport_Stub::StubClientTransport::initialize(
        const IT_WSDL::WSDLPort& wsdl_port
    )
    {
        // get address from the WSDL
        //
        String location;
        //address extensor
        WSDLExtensionElement* wsdl_element =
2         StubTransportWSDLExtensionFactory::get_extension_element(
            wsdl_port,
            StubTransportWSDLAddress::ELEMENT_NAME
        );

        m_address_element =
            IT_DYNAMIC_CAST(StubTransportWSDLAddress *,
                wsdl_element);

        if (m_address_element != 0)
        {
            location = m_address_element->get_location();
        }
    }

    IT_WSDL::WSDLExtensionElement&
3  IT_Transport_Stub::StubClientTransport::get_configuration()
    {
        IT_WSDL::WSDLExtensionElement * elem = 0;
        return *elem;
    }

    void
4  IT_Transport_Stub::StubClientTransport::connect(
        ContextContainer* out_context_container
    )
    {

```

**Example 48:** *Implementation of the StubClientTransport Class*

```

5     String location = m_address_element->get_location();
6     ServerTransportMap::iterator iter =
        m_server_transport_map.find(location);

        if (iter == m_server_transport_map.end())
        {
            throw Exception(
                "Couldn't find server for stub transport address",
                location.c_str()
            );
        }

        m_server_transport = (*iter).second;
    }

void
7 IT_Transport_Stub::StubClientTransport::disconnect()
{
}

void
IT_Transport_Stub::StubClientTransport::invoke_oneway(
    const WSDLOperation& wsdl_operation,
    const BinaryBuffer& request_buffer,
    ContextContainer* out_container,
    ContextContainer* //in_container
)
{
    send(
        wsdl_operation,
        request_buffer,
        out_container
    );
}

void
IT_Transport_Stub::StubClientTransport::invoke(
    const WSDLOperation& wsdl_operation,
    const BinaryBuffer& request_buffer,
    BinaryBuffer& response_buffer,
    ContextContainer* out_container,
    ContextContainer* in_container
)
{

```

**Example 48:** *Implementation of the StubClientTransport Class*

```

        send(
            wsdl_operation,
            request_buffer,
            out_container
        );

        receive(
            wsdl_operation,
            response_buffer,
            in_container
        );
    }

void
8 IT_Transport_Stub::StubClientTransport::send(
    const IT_WSDL::WSDLOperation& wsdl_operation,
    const BinaryBuffer& vvSendBuffer,
    ContextContainer* out_context_container
)
{
9     BinaryBuffer send_buffer(vvSendBuffer);
    m_server_transport->dispatch(send_buffer, m_received);
}

void
10 IT_Transport_Stub::StubClientTransport::receive(
    const IT_WSDL::WSDLOperation& wsdl_operation,
    BinaryBuffer& vvReceiveBuffer,
    ContextContainer* in_context_container
)
{
    vvReceiveBuffer.attach(m_received);
}

```

The preceding client transport implementation can be explained as follows:

1. The main purpose of the `initialize()` function is to initialize the configuration of the client transport port. The `wSDL_port` parameter is an object of `IT_WSDL::WSDLPort` type, which is a parse-tree node containing the data from a WSDL `<port ... > </port>` element.
2. The `get_extension_element()` static function searches the WSDL port node to find a `StubPrefix:address` sub-element, which is then stored in `m_address_element`. See [“Implementing the Extension Element Classes” on page 119](#) for details.
3. The `get_configuration()` function has a dummy implementation.
4. The `connect()` function is responsible for establishing a connection to a service endpoint. In the case of the stub transport, it attempts to find the colocated server transport instance identified by the `location` attribute from the `<StubPrefix:address>` tag.
5. The `get_location()` function returns the value of the `location` attribute from the `<StubPrefix:address>` tag.
6. Search the server transport map, using the `location` attribute as a key, in order to find a colocated `StubServerTransport` instance.  
The entries in the `ServerTransportMap` hash table are created by one or more colocated `StubServerTransport` instances.
7. The `disconnect()` function has a dummy implementation. No action is needed to disconnect from a stub server transport.
8. The `send()` function transmits a WSDL request in the form of a binary buffer, `request_buffer`.
9. For the stub transport, the implementation of `send()` is trivial: you invoke `dispatch()` directly on the colocated stub server transport instance.
10. The `receive()` function returns the binary buffer, `m_received`, that was stored from the previous call to `send()`.

---

## Implementing the Server Transport

---

### Overview

This subsection describes how to make a custom implementation of the `IT_Bus::ServerTransport` class, using the stub server transport as an example. The purpose of the server transport class is to listen for client connection attempts, listen for incoming messages and to dispatch incoming messages up to the Artix binding layer.

---

### Server transport header

[Example 49](#) shows the stub plug-in's server transport class:

#### **Example 49:** *Header for the StubServerTransport Class*

```
// C++
#include <it_bus_pdk/messaging_transport.h>
#include <it_bus_sys/bus_context.h>
#include "stub_transport_wsdl_address.h"
#include "stub_transport_factory.h"

namespace IT_Transport_Stub
{
1   class StubServerTransport : public IT_Bus::ServerTransport
    {
        public:
            StubServerTransport(
                ServerTransportMap & server_transport_map,
                const IT_WSDL::WSDLPort& wsdl_port
            );
            virtual ~StubServerTransport();
2
            virtual void
            activate(
                IT_Bus::TransportCallback& callback,
                IT_WorkQueue::WorkQueue_ptr work_queue = 0
            );

            virtual IT_WSDL::WSDLExtensionElement&
            get_configuration();

            virtual void deactivate();

            virtual void shutdown();

            virtual void
```

**Example 49:** Header for the StubServerTransport Class

```

        send(
            IT_Bus::BinaryBuffer& reply_message,
            IT_Bus::DispatchInfo& dispatch_context
        );

        void dispatch(
            IT_Bus::BinaryBuffer& vvSendBuffer,
            IT_Bus::BinaryBuffer& vvReceiveBuffer
        );

    protected:
3       StubTransportWSDLAddress * m_address_element;
4       IT_Bus::TransportCallback * m_callback;
5       ServerTransportMap & m_server_transport_map;
    };
};

```

The preceding server transport header can be described as follows:

1. The tunnel server transport class must inherit from `IT_Bus::ServerTransport`.
2. The following functions, `activate()`, `get_configuration()`, `deactivate()`, `shutdown()`, `send()`, and `dispatch()`, are all inherited from the `IT_Bus::ServerTransport` base class.
3. The `m_address_element` variable stores a pointer to the `<StubPrefix:address>` WSDL element that defines the location of the server transport.
4. The `m_callback` variable stores a pointer to the `TransportCallback` object, which is used to dispatch requests to the next layer on the server side.
5. The `m_server_transport_map` variable stores a reference to the `ServerTransportMap` instance, which holds a hash table consisting of pairs of location attribute string and pointer to `StubServerTransport`.

**Server transport implementation**

**Example 50** shows the implementation of the server transport class.

**Example 50:** Implementation of the StubServerTransport Class

```

// C++
#include "stub_server_transport.h"
#include "stub_transport_wsdl_extension_factory.h"

```

**Example 50:** *Implementation of the StubServerTransport Class*

```

using namespace IT_Bus;
using namespace IT_WSDL;

1 IT_Transport_Stub::StubServerTransport::StubServerTransport(
    ServerTransportMap & server_transport_map,
    const WSDLPort& wsdl_port
)
: m_server_transport_map(server_transport_map)
{
    m_callback = 0;
    // get address from the WSDL
    //
    String location;
    //address extensor
    WSDLExtensionElement* wsdl_element =
2     StubTransportWSDLExtensionFactory::get_extension_element(
        wsdl_port,
        StubTransportWSDLAddress::ELEMENT_NAME
    );

    m_address_element =
        IT_DYNAMIC_CAST(StubTransportWSDLAddress *, wsdl_element);

    if (m_address_element != 0)
    {
        location = m_address_element->get_location();
    }
}

IT_Transport_Stub::StubServerTransport::~StubServerTransport()
{
}

void
3 IT_Transport_Stub::StubServerTransport::activate(
    IT_Bus::TransportCallback & callback,
    IT_WorkQueue::WorkQueue_ptr work_queue
)
{
    m_callback = &callback;

4     m_server_transport_map.insert(
        ServerTransportMap::value_type(

```



**Example 50:** *Implementation of the StubServerTransport Class*

```

        m_address_element->get_location(),
        this
    )
};

5     m_callback->transport_activated();
}

IT_WSDL::WSDLExtensionElement&
6 IT_Transport_Stub::StubServerTransport::get_configuration()
{
    IT_WSDL::WSDLExtensionElement * elem = 0;
    return *elem;
}

void
7 IT_Transport_Stub::StubServerTransport::deactivate()
{
    // Note: It is impossible to deactivate the stub transport
    // m_callback->transport_deactivated();
}

void
8 IT_Transport_Stub::StubServerTransport::shutdown()
{
    ServerTransportMap::iterator iter =
        m_server_transport_map.find(m_address_element->get_location());

    if (iter != m_server_transport_map.end())
    {
        m_server_transport_map.erase(iter);
    }

9     m_callback->transport_shutdown_complete();
}

void
10 IT_Transport_Stub::StubServerTransport::send(
    BinaryBuffer& reply_message,
    DispatchInfo& dispatch_context
)
{
    assert(0);
}

```

**Example 50:** *Implementation of the StubServerTransport Class*

```

void
11 IT_Transport_Stub::StubServerTransport::dispatch(
    BinaryBuffer& vvSendBuffer,
    BinaryBuffer& vvReceiveBuffer
)
{
    DispatchInfo& dispatch_context =
        m_callback->get_dispatch_context();
12     dispatch_context.provide_response_buffer(
        vvReceiveBuffer
    );
13     m_callback->dispatch(
        vvSendBuffer,
        dispatch_context
    );
}

```

The preceding server transport implementation can be described as follows:

1. The `StubServerTransport` constructor receives two parameters from the transport factory:
  - ◆ `server_transport_map`—a `String` to `StubServerTransport*` map, which is used to advertize the availability of stub server transports to stub client transports.
  - ◆ `wsdl_port`—an object of `IT_WSDL::WSDLPort` type, which is a parse-tree node containing the data from a WSDL `<port ... >` `</port>` element.
2. The `get_extension_element()` static function searches the WSDL port node to find a `StubPrefix:address` sub-element, which is then stored in `m_address_element`. See [“Implementing the Extension Element Classes” on page 119](#) for details.
3. The `activate()` function is called by the Artix core to start up the server transport. It takes the following arguments:
  - ◆ `callback`—the `TransportCallback` object is used to communicate with the Artix core. In particular, `TransportCallback::dispatch()` is used to dispatch requests up to the application code.

- ◆ `work_queue`—this is a NULL pointer, unless you choose the `BORROWS_WORKQUEUE_SELF_DRIVEN` threading resources policy.

The `deactivate()` and `activate()` functions can be used to pause and resume the server transport. The `activate()` function must be non-blocking.

4. Advertise this `StubServerTransport` instance by adding an entry to the server transport map. Because the colocated stub client transports have a reference to the same server transport map instance, they will be able to find the stub server transport by supplying the relevant `location` value as a key.
5. Before exiting the body of the `activate()` function, you must notify the Artix core of the current activation status by calling back on the `IT_Bus::TransportCallback` object. There are two alternatives:
  - ◆ `TransportCallback::transport_activated()`—call this, if the transport activation is successful.
  - ◆ `TransportCallback::transport_activation_failed()`—call this, if the transport activation fails.
6. The `get_configuration()` function has a dummy implementation.
7. The `deactivate()` function is called in order to deactivate the server transport temporarily. It can be used in combination with `activate()` to pause and resume the server transport.

Before exiting the body of the `deactivate()` function, you must notify the Artix core by calling `TransportCallback::transport_deactivated()`.

**Note:** The stub server transport is a special case, however, because it is not possible to deactivate it. Strictly speaking, therefore, we ought *not* to include the `transport_deactivated()` call here.

8. The `shutdown()` function is called by the Artix core while the Bus shuts down. At this point, you should shut down the server transport and perform whatever cleanup is necessary.
9. Before exiting the body of the `shutdown()` function, you must notify the Artix core by calling `TransportCallback::transport_shutdown_complete()`.

10. The `send()` function is called, only if you have configured the server transport to use the asynchronous dispatch model. Because the stub transport uses the synchronous dispatch model, the `send()` function is left unimplemented.

The choice between a synchronous or an asynchronous dispatch model is selected by the *requires stack unwind policy*. If the policy is `true`, the synchronous model is selected; if `false`, the asynchronous model is selected. For more details see [“Implementing the Transport Factory” on page 183](#).

11. This `dispatch()` function is *not* inherited from `IT_Bus::ServerTransport`. It is specific to the stub transport. The `dispatch()` function represents a simple mechanism for stub client transports to send a request and receive a reply from the stub server transport: the client transport simply makes a colocated call on the `StubServerTransport::dispatch()` function.
12. Because this server transport uses the synchronous dispatch model, you must call `DispatchInfo::provide_response_buffer()` to provide a buffer into which the reply message will be written.
13. Call `TransportCallback::dispatch()` to dispatch the request message to the next stage. Because the transport uses the synchronous dispatch model, the reply message is available in the buffer, `vvReceiveBuffer`, as soon as the `TransportCallback::dispatch()` call returns.

---

## Implementing the Transport Factory

---

### Overview

You must implement a transport factory as part of the stub transport implementation. The Artix core calls functions on the transport factory to create `IT_Bus::ClientTransport` and `IT_Bus::ServerTransport` instances as needed.

### Transport factory header

[Example 51](#) shows the stub plug-in's transport factory header.

#### **Example 51:** *Header for the StubTransportFactory Class*

```
// C++
#include <it_bus/bus.h>
#include <it_bus_pdk/messaging_transport.h>
#include <it_bus/string_map.h>

namespace IT_Transport_Stub
{
    class StubServerTransport;
1   typedef IT_Bus::StringMap<StubServerTransport *>
        ServerTransportMap;
2   class StubTransportFactory : public IT_Bus::TransportFactory
    {
    public:
        StubTransportFactory();
        virtual ~StubTransportFactory();

        virtual IT_Bus::ClientTransport *
        create_client_transport();

        virtual void destroy_client_transport(
            IT_Bus::ClientTransport * transport
        );

        virtual IT_Bus::ServerTransport*
        create_server_transport(
            const IT_WSDL::WSDLPort& configuration
        );

        virtual void
        destroy_server_transport(
```

**Example 51:** *Header for the StubTransportFactory Class*

```

        IT_Bus::ServerTransport* transport
    );

    virtual IT_Bus::ThreadingModel
    get_client_threading_model();

    virtual void
    register_wsdl_extension_factories(
        IT_WSDL::WSDLFactory & factory
    ) const;

    virtual void
    deregister_wsdl_extension_factories(
        IT_WSDL::WSDLFactory & factory
    ) const;

    virtual const IT_Bus::TransportPolicyList*
    get_policies();

    void
    initialize(
        IT_Bus::Bus_ptr bus
    );

protected:
    ...
3     ServerTransportMap          m_server_transport_map;
4     IT_Bus::TransportPolicyList* m_transport_policylist;
};
};

```

The preceding header file can be explained as follows:

1. The `ServerTransportMap` type is defined to be a hash table that uses a string key to find pointers to `StubServerTransport` instances. The server transport map is the endpoint discovery mechanism for the stub transport.
2. The `StubTransportFactory` class inherits from the `IT_Bus::TransportFactory` base class.
3. The `m_server_transport_map` variable is the concrete server transport map instance, which is referenced by the client transport objects and the server transport objects.

4. The `m_transport_policylist` variable stores a pointer to an object that encapsulates the stub transport's threading policies.

---

**Transport factory implementation** [Example 52](#) shows the transport factory implementation.

**Example 52:** *Implementation of the StubTransportFactory Class*

```

// C++
#include <it_bus_pdk/pdk_bus.h>
#include "stub_transport_factory.h"
#include "stub_client_transport.h"
#include "stub_server_transport.h"

#include "stub_transport_wsdl_extension_factory.h"

using namespace IT_Bus;

IT_Transport_Stub::StubTransportFactory::StubTransportFactory()
{
}

IT_Transport_Stub::StubTransportFactory::~StubTransportFactory()
{
    delete m_transport_policylist;
}

IT_Bus::ClientTransport *
1 IT_Transport_Stub::StubTransportFactory::create_client_transport
  ()
  {
    return new
    IT_Transport_Stub::StubClientTransport(m_server_transport_map
    );
  }

void
2 IT_Transport_Stub::StubTransportFactory::destroy_client_transpor
  t(
    IT_Bus::ClientTransport * transport
  )
  {
    delete transport;
  }

IT_Bus::ServerTransport*

```

**Example 52:** *Implementation of the StubTransportFactory Class*

```

3 IT_Transport_Stub::StubTransportFactory::create_server_transport
  (
    const IT_WSDL::WSDLPort& wsdl_port
  )
  {
    return new IT_Transport_Stub::StubServerTransport(
        m_server_transport_map,
        wsdl_port
    );
  }

void
4 IT_Transport_Stub::StubTransportFactory::destroy_server_transpor
  t(
    IT_Bus::ServerTransport* transport
  )
  {
    delete transport;
  }

IT_Bus::ThreadingModel
5 IT_Transport_Stub::StubTransportFactory::get_client_threading_mo
  del()
  {
    return IT_Bus::MULTI_INSTANCE;
  }

6 extern IT_Transport_Stub::StubTransportWSDLExtensionFactory
  it_glob_stub_transport_wsdl_extension_factory_instance;

void
7 IT_Transport_Stub::StubTransportFactory::register_wsdl_extensio
  _factories(
    IT_WSDL::WSDLFactory & factory
  ) const
  {
8     factory.register_extension_factory(
        "http://schemas.ionac.com/transport/stub",
        it_glob_stub_transport_wsdl_extension_factory_instance
    );
  }

void
9 IT_Transport_Stub::StubTransportFactory::deregister_wsdl_extensi
  on_factories(

```



**Example 52:** *Implementation of the StubTransportFactory Class*

```

        IT_WSDL::WSDLFactory & factory
    ) const
    {
    }

10  const TransportPolicyList*
    IT_Transport_Stub::StubTransportFactory::get_policies()
    {
        return m_transport_policylist;
    }

11  void
    IT_Transport_Stub::StubTransportFactory::initialize(
        Bus_ptr bus
    )
    {
12      m_transport_policylist =
13          bus->get_pdk_bus()->create_transport_policy_list();
14      m_transport_policylist->set_policy_threading_resources(EXTERNALL
        Y_DRIVEN);
        m_transport_policylist->set_policy_requires_concurrent_dispatch(
            true);
        m_transport_policylist->set_policy_requires_stack_unwind(true);
    }

```

The preceding transport factory implementation can be explained as follows:

1. The `create_client_transport()` function is called by the Artix core whenever a new `StubClientTransport` instance is needed. The `StubClientTransport` constructor takes one parameter: a reference to the server transport map, which enables the stub client transport to discover stub service endpoints.
2. The `destroy_client_transport()` function is normally implemented exactly as shown here.
3. The `create_server_transport()` function is called by the Artix core whenever a new `StubServerTransport` instance is needed. The `StubServerTransport` constructor takes two parameters:
  - ◆ A reference to the server transport map, which enables the stub server transport to advertise its existence to colocated clients.

- ◆ A reference to the WSDL port that contains a description of this service endpoint.
4. The `destroy_server_transport()` function is normally implemented exactly as shown here.
  5. The `get_client_threading_model()` is implemented to select the `MULTI_INSTANCE` client threading model.
  6. This variable references a global static instance of the stub plug-in's WSDL extension factory.
  7. The `register_wsdl_extension_factories()` function is called by the Artix core while the stub plug-in is initializing. It gives you an opportunity to register one or more WSDL extension factories with the Bus.
  8. This line registers the stub plug-in's WSDL extension factory, associating it with the `http://schemas.iona.com/transport/stub` namespace URI. This is the namespace that can be associated with the `StubPrefix` to let you configure the `StubPrefix:address` element in your WSDL contract.
  9. As the stub plug-in shuts down, it calls `deregister_wsdl_extension_factories()`.
  10. As the stub plug-in starts up, the Artix core calls `get_policies()` to discover what policies are to be used with this transport plug-in (the policies are mostly concerned with server threading).
  11. If you need to customize the transport policy list, you can do this in the body of the `initialize()` function.
  12. Usually, when the server transport's threading policy is set to `EXTERNALLY_DRIVEN`, it would imply that the server transport code creates its own reader threads to process incoming requests. In this case, because the stub transport is a colocated transport, the situation is somewhat exceptional. The reader thread is actually provided by the client side—the client transport simply calls the server transport's `dispatch()` function directly.
  13. The server's concurrent dispatch policy is set to `true`. This indicates to the Artix core that the stub server transport is liable to make concurrent dispatches to the server-side binding (by calling `TransportCallback::dispatch()` from multiple threads).

14. The requires stack unwind policy is set to `true`. This selects a synchronous approach to dispatching requests on the server side. If you enable the stack unwind policy, you must implement your server transport according to the following pattern:
  - ◆ Do not implement `ServerTransport::send()` (this function is only used to receive replies asynchronously).
  - ◆ In the implementation of `ServerTransport::dispatch()`, prior to calling `TransportCallback::dispatch()`, call `DispatchContext::provide_response_buffer()` to specify a buffer into which the result will be written.
  - ◆ As soon as `TransportCallback::dispatch()` returns, the response buffer contains the reply.

---

## Registering and Packaging the Transport

---

### Stub plug-in name

[Example 53](#) shows how to register the stub transport plug-in by creating a static instance of `IT_Bus::BusORBPlugIn` type. The constructor registers the plug-in under the specified name, `stub_transport`.

#### **Example 53:** *Registering the Stub Transport Plug-In*

```
// C++
namespace IT_Bus {
    ...
    const char* const und_stub_transport_plugin_name =
        "stub_transport";

    StubTransportBusPlugInFactory
    und_stub_transport_plugin_factory;

    IT_Bus::BusORBPlugIn und_stub_transport_plugin(
        und_stub_transport_plugin_name,
        und_stub_transport_plugin_factory
    );
}
```

### Registering the stub transport factory with the Bus

[Example 54](#) shows how to register the stub transport factory with the Bus.

#### **Example 54:** *Registering the Stub Transport Factory*

```
// C++
void
StubTransportBusPlugIn::bus_init(
) IT_THROW_DECL((IT_Bus::Exception))
{
    IT_Bus::Bus_ptr bus = get_bus();
    assert(bus != 0);

    m_transport_factory.initialize(bus);
    bus->get_pdk_bus()->register_transport_factory(
        "http://schemas.iona.com/transport/stub",
        &m_transport_factory
    );
}
```

**Example 54:** *Registering the Stub Transport Factory*

```

void
StubTransportBusPlugIn::bus_shutdown(
) IT_THROW_DECL( (IT_Bus::Exception) )
{
    IT_Bus::Bus_ptr bus = get_bus();
    assert( bus != 0 );

    bus->get_pdk_bus()->deregister_transport_factory(
        "http://schemas.iona.com/transport/stub"
    );
}

```

To register the transport factory, perform the following steps:

1. Call the `IT_Bus::TransportFactory::initialize()` function to initialize the transport factory.
2. Call the `IT_Bus::PDKBus::register_transport_factory()` factory to register the transport factory.

**Configuring the stub transport plug-in**

To configure an application to use the stub transport plug-in, you must add the plug-in name, `stub_transport`, to the `orb_plugins` list, as follows:

**Example 55:** *Configuring the Stub Transport Plug-In*

```

# Artix Configuration File

ApplicationScope {
    orb_plugins = [ ..., "stub_transport" ];
    ...
};

```



# Artix Logging Reference

*This chapter explains how to use Artix TRACE macros, and explains the Artix logging APIs.*

---

**In this chapter**

This chapter includes the following sections:

<a href="#">Using Artix TRACE Macros</a>
--

<a href="#">page 194</a>
--------------------------

---

# Using Artix TRACE Macros

---

## Overview

This section describes how to use TRACE macros in your own code in order to send logging messages to the Artix event log. The output from this Artix logging mechanism can then be controlled using the configuration settings described in *Deploying and Managing Artix Solutions*.

This section describes the following aspects of using Artix TRACE macros:

- [Header file](#).
- [Initializing the Bus logger](#).
- [Artix subsystem scope](#).
- [Artix trace levels](#).
- [Passing in arguments](#).
- [Creating your own output](#).

---

## Header file

To use the Artix TRACE macros, you must include the `it_bus/bus_logger.h` header as follows:

```
#include <it_bus/bus_logger.h>
```

**Note:** In versions prior to Artix 3.0.2, the `it_bus/logging_support.h` header was used instead. This header is now deprecated, but it can be used to support legacy logging code.



## Initializing the Bus logger

In order to control logging independently for each Bus, it is necessary to initialize a Bus logger object and associate it with a particular Bus instance. The Bus logger must be initialized before you can perform any tracing.

The normal way to initialize a Bus logger instance is to define it as a member of the class you happen to be implementing. For example, you can define and initialize a Bus logger instance in a class, `MyClass`, as follows:

1. Declare a `BusLogger` pointer by inserting the

`IT_DECLARE_BUS_LOGGER_MEM` macro as a protected member in the class header file:

```
// C++
class myClass {
    ...
protected:
    IT_DECLARE_BUS_LOGGER_MEM
};
```

2. In the class constructor, call the `IT_INIT_BUS_LOGGER_MEM` macro to initialize the `BusLogger` instance, passing a valid Bus instance to the macro argument:

```
// C++
myClass::myClass(IT_Bus::Bus_ptr bus) : m_bus(bus)
{
    IT_INIT_BUS_LOGGER_MEM(m_bus)
}
```

3. In the class destructor, call the `IT_FINALISE_BUS_LOGGER_MEM` macro to clean up the `BusLogger` instance.

```
// C++
myClass::~myClass()
{
    IT_FINALISE_BUS_LOGGER_MEM(m_bus)
}
```

The Bus pointer passed to the macro in the destructor must be the same as the one passed to the macro in the constructor.

## Artix subsystem scope

Artix uses a hierarchy of subsystem scopes that enables you to filter the messages that go into the event log. Artix uses several different subsystem scopes internally, for example:

```
IT_BUS.CORE
IT_BUS.TRANSPORT.HTTP
IT_BUS.BINDING.SOAP
IT_BUS.BINDING.CORBA
IT_BUS.BINDING.CORBA.RUNTIME
```

You can then define an event log filter in the Artix configuration file to control the level of logging from each of the subsystems. For example:

```
# Artix Configuration File
event_log:filters=["IT_BUS=FATAL+ERROR",
                  "IT_BUS.BINDING.CORBA=WARN+FATAL+ERROR"];
```

The default subsystem scope for any TRACE macros in your code is `IT_BUS`. Instead of using the default, however, it is better to specify a subsystem scope explicitly by defining the `_IT_SUBSYSTEM_SCOPE` macro in your code.

For example, if you are generating logging messages from a custom transport, you could define the subsystem scope as follows:

```
// C++
// Class implementation file.

// Header files:
#include <it_bus/bus_logger.h>
...

// Define the _IT_SUBSYSTEM_SCOPE *after* including the headers.
#define _IT_SUBSYSTEM_SCOPE IT_BUS.TRANSPORT
```

You can define the subsystem scope to be any identifier consisting of alphanumeric characters and the `.` character. The `.` character is used as a delimiter to separate the subsystem levels.

## Artix trace levels

When the event log filter and log stream are properly configured, the Artix logging output from the TRACE macros is sent to the event log.

When using TRACE macros, the most important concept is the trace level, which is an `enum` that lets you filter events. Trace levels are defined in the `ArtixInstallDir/include/it_bus/logging_defs.h` file:

```
const IT_TraceLevel IT_TRACE_FATAL = 64;           //FATAL
const IT_TraceLevel IT_TRACE_ERROR = 32;          //ERROR
const IT_TraceLevel IT_TRACE_WARNING = 16;        //WARNING
const IT_TraceLevel IT_TRACE = 4;                 //INFO_HIGH
const IT_TraceLevel IT_TRACE_BUFFER = 2;         //INFO_MED
const IT_TraceLevel IT_TRACE_METHODS = 1;        //INFO_LOW
const IT_TraceLevel IT_TRACE_METHODS_INTERNAL = 1; //INFO_LOW
```

The simplest trace statement emits a constant string at level `IT_TRACE`. For example:

```
TRACELOG("Hello world");
```

## Passing in arguments

Several versions of the macro allow using a C `printf` format string, and passing in some arguments. Because you cannot have variable argument lists for macros, there are several defined according to how many arguments are allowed:

```
TRACELOG1("My name is: %s", "Slim Shady");
TRACELOG2("At state number %d, this happened: %s", 44, "connection failure");
```

Both the zero argument and the multiple argument versions have a setting that allows a trace level to be passed in, instead of level `IT_TRACE`. For example:

```
TRACELOG_WITH_LEVEL(IT_METHODS, "MyClass::MyClass()");
TRACELOG_WITH_LEVEL1(IT_TRACE_METHODS_INTERNAL, "Value of my_name_field was %s", my_name_field);
```

## Creating your own output

If you need to create your own output using `iostreams` or another expensive process that is not supported by the macro, use the trace guard block. This ensures that the trace level test prevents your trace creation code from running when it does not produce output. For example:

```
BEGIN_TRACE(IT_TRACE)
    String trace_message = "data elements: ";
    for(i = 0; i < data_count; i++)
    {
        trace_message = trace_message + data_item[i] + "
";
    }
    TRACELOG(trace_message.c_str());
END_TRACE
```

To create binary output (for instance, a hex dump of the buffer), use `TRACELOGBUFFER`. For example:

```
TRACELOGBUFFER(vvMQMessageData, vvMQMessageData.GetSize())
```

If the trace statement issues at a level less than or equal to the process trace level, the entry is written to disk. The default log file name is `it_bus.log`.

# WS-RM Persistence

*This chapter describes how to write a custom plug-in that implements the persistence feature for WS-ReliableMessaging (WS-RM). The WS-RM specification defines a protocol for the assured delivery of SOAP messages (or sequences of SOAP messages) to a Web service destination. By enhancing WS-RM with a persistence feature, you can ensure that messages get delivered even after a program crash.*

---

**In this chapter**

This chapter includes the following sections:

<a href="#">Introduction to WS-RM Persistence</a>	page 200
<a href="#">WS-RM Persistence API</a>	page 204
<a href="#">Persistence and Recovery Algorithms</a>	page 216
<a href="#">Implementing a WS-RM Persistence Plug-In</a>	page 227

---

# Introduction to WS-RM Persistence

---

## Overview

Figure 18 shows an overview of how the WS-ReliableMessaging (WS-RM) protocol works with persistence enabled. You would deploy the WS-RM protocol in situations where delivery assurances are required, even if the underlying transport is unreliable. Instead of talking about clients and servers, the WS-RM specification talks about *source endpoints* and *destination endpoints*. Messages are transmitted from source endpoints and received by destination endpoints.

**Figure 18:** Overview of WS-ReliableMessaging with Persistence

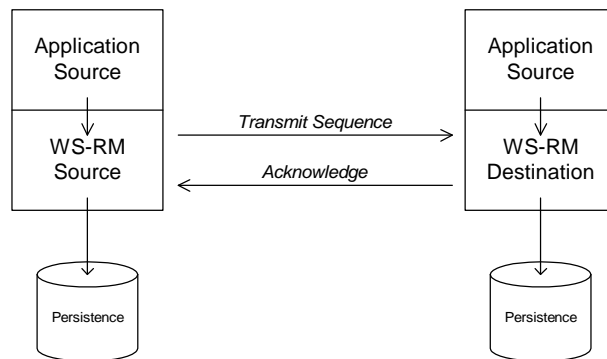

## Message sequence

Under the WS-RM protocol, messages are grouped into sequences. A *message sequence* consists of one or more messages.

## Application source

The *application source* represents the application code that has a message (or messages) to send. The WS-RM delivery assurances come into effect as soon as the application source transfers a message to the WS-RM source.

## Application destination

The *application destination* represents the application code that ultimately receives and processes the message. The WS-RM delivery guarantee is fulfilled, as soon as the application destination takes delivery of the message from the WS-RM destination.

**WS-RM source**

A *WS-RM source* is an endpoint that is responsible for transmitting a message with specific delivery assurances.

**WS-RM destination**

A *WS-RM destination* is an endpoint that is responsible for receiving a message with specific delivery assurances.

**WS-RM persistence plug-in**

To provide message persistence for the WS-RM layer, you can implement your own custom WS-RM persistence plug-in. The persistence plug-in integrates the WS-RM layer with a database. Messages can then be stored in the database as long as necessary to guarantee message delivery, even if one of the application programs crashes.

**Sample message exchange**

Figure 19 shows an example of a WS-RM message exchange, where the WS-RM source sends a sequence of three messages to the WS-RM destination. The message types shown in this example refer to SOAP messages containing the appropriate WS-RM headers.

**Figure 19:** *Sample WS-RM Message Exchange Pattern*

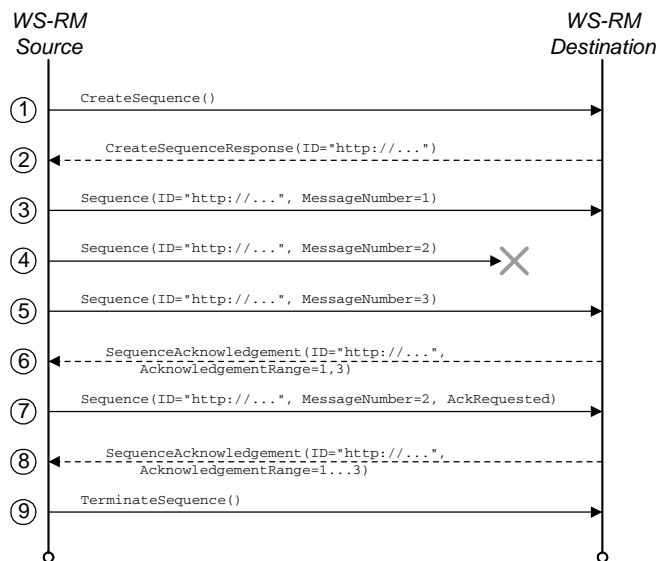

---

**Steps in the message exchange**

The steps shown in the message exchange of [Figure 19](#) are, as follows:

1. The message exchange pattern is initiated when the source sends a `CreateSequence` message to the destination.
2. The destination responds by sending a `CreateSequenceResponse` message back to the source.
3. Transmit the first message of a three message sequence. If persistence is enabled, the WS-RM source saves the message before transmitting.
4. Transmit the second message. If persistence is enabled, the WS-RM source saves the message before transmitting.

In this example, it is assumed that the second message gets lost. This can happen even if the underlying protocol is reliable (like HTTP), because a WS-RM session can span multiple connections. For example, consider what happens if a HTTP connection drops while the second message is being sent. The WS-RM source then transparently re-opens a HTTP connection to send the third message. The second message is now missing, even though the underlying protocol is reliable.

5. Transmit the final message of the sequence. A `LastMessage` flag in the WS-RM header signals to the destination that this is the last message in the sequence.
  6. The destination sends an acknowledgement back to the source, confirming that message numbers 1 and 3 were received.
  7. The source endpoint can now remove messages 1 and 3 from the WS-RM persistent storage. The second message must be resent, however, because no acknowledgement for this message has been received.
  8. The destination sends an acknowledgement back to the source, confirming that message numbers 1, 2, and 3 were received.
  9. The source terminates the message exchange pattern by sending a `TerminateSequence` message to the destination endpoint.
- 

**Adding persistence to the message exchange protocol**

The key benefit of adding persistence to the message exchange protocol is that delivery of messages to the application destination can be guaranteed, even if one of the application programs crashes.



When persistence is enabled, the source endpoint persists messages locally before attempting to transmit to the destination endpoint. Likewise, the destination endpoint persists messages as soon as they arrive. The messages stored on the destination side can then be erased, once they have been delivered to the application destination.

---

**Standard persistence plug-in**

Artix provides a default WS-RM persistence plug-in that stores data in a Berkeley database. For more details, see [Configuring and Deploying Artix Solutions](#).

---

**Custom persistence plug-in**

If you want to provide your own implementation of WS-RM persistence (for example, if you prefer to use a database other than Berkeley DB), follow the instructions in this chapter to implement a *custom persistence plug-in*.

---

**References**

You can read more about the Artix support for WS-ReliableMessaging in the following documents:

- [Configuring and Deploying Artix Solutions](#).
- [Developing Artix Applications in C++](#).

The WS-ReliableMessaging specification is available from Oasis, at the following location:

- [Web Services Reliable Messaging Protocol](#)

---

# WS-RM Persistence API

**Overview**

---

This section describes the base classes that you need to define in order to implement the WS-RM persistence feature.

---

**In this section**

This section contains the following subsections:

<a href="#">Overview of the Persistence API</a>	<a href="#">page 205</a>
<a href="#">RMPersistentManager Class</a>	<a href="#">page 206</a>
<a href="#">RMEndpointPersistentStore Class</a>	<a href="#">page 210</a>
<a href="#">RMSequencePersistentStore Class</a>	<a href="#">page 213</a>

---

## Overview of the Persistence API

---

### Overview

Figure 20 shows an overview of the WS-RM persistence API, which consists of three classes: `IT_Bus::RMPersistentManager`, `IT_Bus::RMEndpointPersistentStore`, and `IT_Bus::RMSequencePersistentStore`. In order to write a WS-RM persistence plug-in, you must provide an implementation for each of these API classes.

**Figure 20:** *Overview of the WS-RM Persistence API*

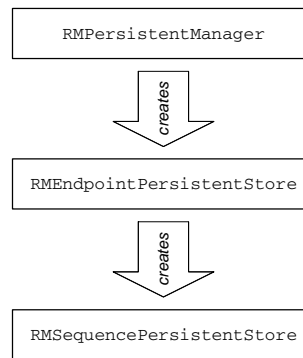

---

### RMPersistentManager class

The `IT_Bus::RMPersistentManager` class is the basic point of contact between the WS-RM core and the WS-RM persistence layer. This class is responsible for connecting to the database and managing the persistence of WS-RM source endpoints and WS-RM destination endpoints.

---

### RMEndpointPersistentStore class

The `IT_Bus::RMEndpointPersistentStore` class represents the persistent storage for a particular WS-RM endpoint (could be either a source endpoint or a destination endpoint). This class effectively acts as a container for message sequences.

---

### RMSequencePersistenceStore class

The `IT_Bus::RMSequencePersistenceStore` class represents the persistent storage for a particular WS-RM message sequence. This class effectively acts as a container for messages.

## RMPersistentManager Class

### Overview

The `IT_Bus::RMPersistentManager` class provides the basic point of contact between the WS-RM core and WS-RM persistence plug-in. You must implement this class in order to implement a WS-RM persistence plug-in.

For details of how to register an `IT_Bus::RMPersistentManager` instance, see [“Implementing a WS-RM Persistence Plug-In” on page 227](#).

### RMPersistentManager class header

[Example 56](#) shows the header for the `IT_Bus::RMPersistentManager` class, with some hints on how to implement each member function.

#### Example 56: *The RMPersistentManager Class Header*

```
// C++
#include <it_bus/types.h>

namespace IT_Bus
{
    class String;
    class QName;
    class BinaryBuffer;

    class RMPersistentManager
    {
    public:
        1 virtual RMEndpointPersistentStore*
           rm_source_endpoint_created(
               const QName& wsdl_service_qname,
               const String& wsdl_port_name,
               const String& stringified_wsa_epr,
               const String& endpoint_address
           ) = 0;

        2 virtual RMEndpointPersistentStore*
           rm_destination_endpoint_created(
               const QName& wsdl_service_qname,
               const String& wsdl_port_name,
               const String& stringified_wsa_epr
           ) = 0;

        3 virtual void
           rm_endpoint_closed(
```

**Example 56:** *The RMPersistentManager Class Header*

```

        RMEndpointPersistentStore* ep_store
    ) = 0;

    virtual RMEndpointPersistentStore*
4     get_next_source_endpoint_to_recover() = 0;
5
    virtual void cleanup_persistent_store() = 0;
};
...
}

```

The preceding class header can be explained as follows:

1. The `rm_source_endpoint_created()` function is called by the WS-RM core just after a WS-RM source endpoint is created.

The arguments to `rm_source_endpoint_created()` are used as follows:

- ◆ *Database key*—the service name, `wSDL_service_qname`, and port name, `wSDL_port_name`, together should be used to generate a database key.

**Note:** The `rm_source_endpoint_created()` function will be called multiple times with the *same* service/port combination, if the user creates multiple proxies. You must ensure that a *unique* database key is generated whenever this function is called, even if the service/port combination is the same.

- ◆ *Database data*—the string arguments, `stringified_wsa_epr` and `endpoint_address`, should be stored in the keyed database record. You also need to create a record for WS-RM source endpoint data.

When this function is called, you should create an entry in your database to store the WS-RM source endpoint details.

2. The `rm_destination_endpoint_created()` function is called by the WS-RM core just after a WS-RM destination endpoint is created.

The arguments to `rm_destination_endpoint_created()` are used as follows:

- ◆ *Database key*—the service name, `wSDL_service_qname`, and port name, `wSDL_port_name`, together should be used as a database key.

- ◆ *Database data*—the string argument, `stringified_wsa_epr`, should be stored in the keyed database record. You also need to create a record for WS-RM destination endpoint data.

It is possible that `rm_destination_endpoint_created()` might be called more than once for a given service name and port name combination. If this happens, re-use the existing database record (as keyed by the service name and port name) rather than create a new record.

3. The `rm_endpoint_closed()` function is called by the WS-RM core after an endpoint has been shut down.

To implement this function, delete all of the database records associated with the specified endpoint instance. The WS-RM core guarantees that this function is called only after all of the sequences have been terminated.

4. The `get_next_source_endpoint_to_recover()` function is called by the WS-RM core during recovery after a program crash.

The `get_next_source_endpoint_to_recover()` function should be implemented to behave as follows:

- i. The first time this function is called, it should retrieve the list of WS-RM source endpoints from the database and return a pointer to the first endpoint instance.
- ii. On each subsequent call, the function should return a pointer to the next source endpoint in the list.
- iii. When the end of the list has been reached, the function should return zero.

**Note:** The WS-RM core runs through this call sequence only once per session. Hence, it is not strictly necessary to reset this iterator function at the end of the list.

5. The `cleanup_persistent_store()` function is called by the WS-RM core during a normal program shutdown (bus shutdown), at which point all of the sequences will have been terminated.

To implement this function, delete *all* of the database records associated with the current program.

**Note:** When a sequence has been terminated, that does not necessarily imply that all of its message have been transmitted and acknowledged or that all of the messages have been delivered. When a process shuts down gracefully, WS-RM sends a `wsm:SequenceTerminated` fault to the peer endpoint to terminate each sequence.

## RMEndpointPersistentStore Class

### Overview

The `IT_Bus::RMEndpointPersistentStore` class stores details either for a source endpoint or for a destination endpoint. It also acts as a container for WS-RM message sequences. You must implement this class in order to implement a WS-RM persistence plug-in.

### RMEndpointPersistentStore class header

**Example 57** shows the header for the `IT_Bus::RMEndpointPersistentStore` class, with some hints on how to implement each member function.

#### **Example 57:** *The RMEndpointPersistentStore Class Header*

```
// C++
#include <it_bus/types.h>

namespace IT_Bus
{
    class String;
    class QName;
    class BinaryBuffer;

    class RMEndpointPersistentStore
    {
    public:
1      virtual const QName& get_service_name() = 0;
        virtual String get_port_name() = 0;
        virtual String get_address() = 0;
        virtual String get_stringified_epr() = 0;
2      virtual void store_address(
            const String& endpoint_address
        ) = 0;
3      virtual RMSequencePersistentStore* sequence_created(
            const String& sequence_id,
            const String& acksto_uri
        ) = 0;
4      virtual bool endpoint_needs_recovery() = 0;

        virtual RMSequencePersistentStore*
5      get_next_sequence_to_recover() = 0;
    };
};
```



**Example 57:** *The RMEndpointPersistentStore Class Header*

```
}

```

The preceding header class can be explained as follows:

1. The following functions—`get_service_name()`, `get_port_name()`, `get_address()`, and `get_stringified_epr()`—return basic data from the endpoint’s database record.
2. The `store_address()` updates the endpoint address field (that is, the same field that is accessible by calling `get_address()`).

This function is called *only* in a destination endpoint, after the endpoint is activated. The sequence of events is as follows:

- i. When a destination endpoint is created, the WS-RM core calls `rm_destination_endpoint_created()`.
  - ii. The destination endpoint is activated, at which point the URL address becomes known (for example, the operating system would allocate an IP address during activation).
  - iii. The WS-RM core calls `store_address()`, to pass on the activated address.
3. The `sequence_created()` function is called by the WS-RM core just after a new WS-RM sequence is created.  
To implement this function, you should store the `sequence_id` and `acksto_uri` strings in the endpoint’s database record.
  4. The `endpoint_needs_recovery()` function is called by the WS-RM core during recovery after a program crash.  
This function must return `true`, if there are messages stored in this endpoint’s database record that were not sent before the program crashed.
  5. The `get_next_sequence_to_recover()` function is called by the WS-RM core during recovery after a program crash.

The `get_next_sequence_to_recover()` function should be implemented to behave as follows:

- i. The first time this function is called, it should retrieve the list of message sequences from the database and return a pointer to the first sequence instance.
- ii. On each subsequent call, the function should return a pointer to the next sequence in the list.
- iii. When the end of the list has been reached, the function should return zero.

---

## RMSequencePersistentStore Class

---

### Overview

The `IT_Bus::RMSequencePersistentStore` class acts as a container for messages belonging to a particular message sequence, where the messages are stored persistently. You must implement this class in order to implement a WS-RM persistence plug-in.

---

### RMSequencePersistentStore class header

**Example 58** shows the header for the `IT_Bus::RMSequencePersistentStore` class, with some hints on how to implement each member function.

#### **Example 58:** *The RMSequencePersistentStore Class Header*

```
// C++
#include <it_bus/types.h>

namespace IT_Bus
{
    class String;
    class QName;
    class BinaryBuffer;

    class RMSequencePersistentStore
    {
    public:
1      virtual String get_sequence_id() = 0;
      virtual String get_acksto_uri() = 0;

2      virtual bool store_message(
          IT_Bus::ULong message_id,
          BinaryBuffer& message,
          bool          is_last_message
        ) = 0;

3      virtual void remove_message(
          IT_Bus::ULong message_id,
          bool          highest_delivered_message_id
        ) = 0;

4      virtual void store_acknowledgement(
          const String& stringified_ack_range
        ) = 0;

5      virtual IT_Bus::ULong get_last_message_id() = 0;
    };
};
```

**Example 58:** *The RMSequencePersistentStore Class Header*

```

6     virtual void sequence_terminated() = 0;
7     virtual BinaryBuffer* get_next_message_to_recover(
        IT_Bus::ULong& message_id
    ) = 0;
    };
}

```

The preceding header class can be explained as follows:

1. The following functions—`get_sequence_id()`, and `get_acksto_uri()`—return the sequence’s ID and `wsa:acksTo` URI from the database record.
2. The `store_message()` function is called by the WS-RM core each time a message is about to be sent as part of this message sequence.

To implement this function, store the message buffer, `message`, and the message ID, `message_id`, in the database. The `is_last_message` argument is used by the WS-RM core to indicate that this is the last message in the sequence.

The boolean value returned from `store_message()` is `true`, if the message is successfully persisted, and `false`, otherwise.

3. The `remove_message()` function is called by the WS-RM core after the specified message (identified by the `message_id` argument) has been acknowledged (source side) or delivered (destination side).

To implement this function, remove the specified message from the endpoint’s database record. The `highest_delivered_message_id` flag is used *only* for destination endpoints. The flag is `true`, if the current message has the highest ID of all the messages delivered so far in this sequence. When the flag is `true`, you should store the value of the `message_id` argument in the database.

4. *No implementation required*—this function is currently unused.

The `store_acknowledgement()` function would be called by the WS-RM core whenever an acknowledgement message is received. This function is not needed, if `InOrder` delivery assurance is enabled. Currently, Artix always requires `InOrder` delivery assurance.

5. The `get_last_message_id()` returns the last message ID of the current sequence. The returned value depends on whether the current endpoint is a source endpoint or a destination endpoint:
- ◆ *Source endpoint*—returns the ID for the last message of the sequence or 0, if the last message has not been persisted yet.
  - ◆ *Destination endpoint*—returns the highest message ID that has been delivered so far. This is the message ID previously stored by calling `remove_message()`.

**Note:** On the destination side, the highest message ID is relevant only if the `InOrder` delivery assurance policy is in force. The `InOrder` delivery assurance guarantees that messages are delivered in the same order in which they were sent.

6. The `sequence_terminated()` function is called by the WS-RM core after the complete message sequence has been delivered.
- To implement this function, remove all details of the specified message sequence from the database (including any messages that might still be stored).
7. The `get_next_message_to_recover()` function is called by the WS-RM core during recovery after a program crash.
- The `get_next_message_to_recover()` function is called iteratively to return each message for recovery. The return value from the function is a pointer to a buffer containing the message and the out argument, `message_id`, returns the message's ID. If there are no more messages in the store, the function returns 0.

---

# Persistence and Recovery Algorithms

---

**Overview**

To implement a custom WS-RM persistence plug-in correctly, it is helpful to understand the way in which the WS-RM core persists and recovers data for the source and destination endpoints. This section describes the interactions between the WS-RM core and a custom WS-RM persistence plug-in for some basic persistence and recovery scenarios.

---

**In this section**

This section contains the following subsections:

<a href="#">Persistence at a Source Endpoint</a>	<a href="#">page 217</a>
<a href="#">Recovery of a Source Endpoint</a>	<a href="#">page 219</a>
<a href="#">Persistence at a Destination Endpoint</a>	<a href="#">page 221</a>
<a href="#">Recovery of a Destination Endpoint</a>	<a href="#">page 224</a>

---

## Persistence at a Source Endpoint

---

### Overview

This subsection describes the typical interaction between the WS-RM core and a WS-RM persistence plug-in, providing persistence for a WS-RM source endpoint.

Figure 21 gives a schematic overview of the steps involved in persisting a source endpoint.

**Figure 21:** *Overview of Persisting a Source Endpoint*

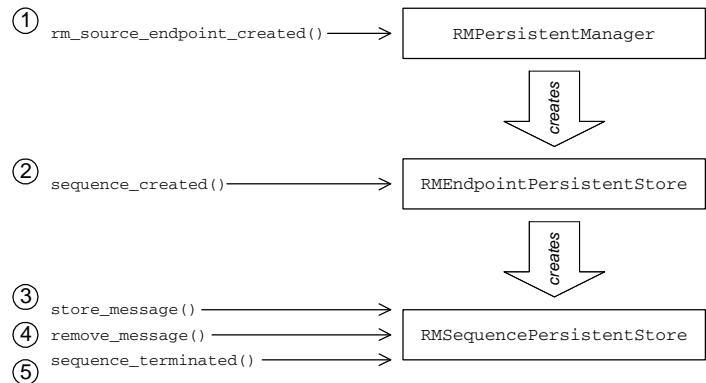

### Persistence steps for a source endpoint

The steps shown in [Figure 21](#) for persisting a source endpoint can be explained as follows:

Stage	Description
1	After a WS-RM source endpoint is created, the WS-RM core calls <code>rm_source_endpoint_created()</code> on the <code>RMPersistentManager</code> object, in order to create an instance of a source endpoint in the persistent store.
2	When the source endpoint initiates a WS-RM message sequence, the WS-RM core calls <code>sequence_created()</code> on the <code>RMEndpointPersistentStore</code> object. This call is made after receipt of the <code>CreateSequenceResponse</code> message, which indicates completion of the sequence establishment handshake.
3	Before each message is sent out on the wire, the WS-RM core saves the message to the persistent store by calling <code>store_message()</code> on the <code>RMSequencePersistentStore</code> object.  If the current message is the last message of the sequence, the WS-RM core calls <code>store_message()</code> with the <code>is_last_message</code> flag equal to <code>true</code> . This sets the value of the last message ID, which is accessible through the <code>get_last_message_id()</code> function. When <code>is_last_message</code> is <code>true</code> , it implies that the final message includes a <code>wsm:LastMessage</code> element.
4	When the source endpoint receives an acknowledgement, it iterates through the acknowledgement range and calls <code>remove_message()</code> on the <code>RMSequencePersistentStore</code> object to erase each acknowledged message from the persistent store.
5	After the source endpoint sends the <code>TerminateSequence</code> message, the WS-RM core calls <code>sequence_terminated()</code> on the <code>RMSequencePersistentStore</code> object.



## Recovery of a Source Endpoint

### Overview

This subsection describes the typical interaction between the WS-RM core and a WS-RM persistence plug-in, where the source endpoint is attempting to recover after a program crash.

A recovering source endpoint operates in two distinct modes:

1. *Recovery mode*—when an application program restarts after a crash, it enters recovery mode, as described in this subsection.

During recovery mode, WS-RM attempts to resend all of the unacknowledged messages, and after all of the messages have been acknowledged, the WS-RM core closes the message sequences and endpoints and cleans up the database.

2. *Normal mode*—after recovery, when a user creates a proxy, the source endpoint starts to operate in normal mode, as described in “[Persistence at a Source Endpoint](#)” on page 217.

### Recovery of a source endpoint

Figure 22 gives a schematic overview of the steps involved in recovering a source endpoint.

**Figure 22:** *Overview of Recovering a Source Endpoint*

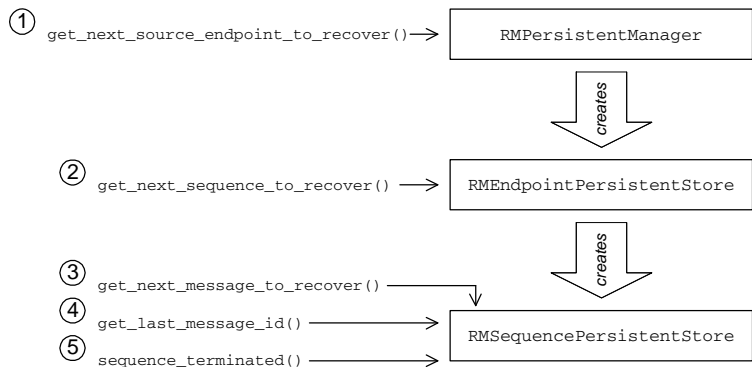

### Recovery steps for a source endpoint

The steps shown in [Figure 22](#) for recovering a source endpoint can be explained as follows:

Stage	Description
1	When a program initiates recovery after a crash, the WS-RM core iteratively calls <code>get_next_source_endpoint_to_recover()</code> on the <code>RMPersistentManager</code> object in order to obtain a list of all the source endpoints to recover (where each source endpoint is represented by an <code>RMEndpointPersistentStore</code> object).
2	On each of the endpoints to be recovered, the WS-RM core iteratively calls <code>get_next_sequence_to_recover()</code> in order to obtain a list of message sequences to recover (where each message sequence is represented by an <code>RMSequencePersistentStore</code> object).
3	The WS-RM core iteratively calls <code>get_next_message_to_recover()</code> on each sequence in order to assemble a list of unsent message for each sequence.
4	At the end of each sequence, the WS-RM core calls <code>get_last_message_id()</code> to determine whether a <code>LastMessage</code> message was sent. If the function returns 0, the source endpoint must send a <code>LastMessage</code> message to finish the sequence.
5	After resending all of the outstanding messages and receiving acknowledgements for them, the WS-RM core calls <code>sequence_terminated()</code> on the relevant <code>RMSequencePersistentStore</code> object.

---

## Persistence at a Destination Endpoint

---

### Overview

This subsection describes the typical interaction between the WS-RM core and a WS-RM persistence plug-in, providing persistence for a WS-RM destination endpoint.

Figure 23 gives a schematic overview of the steps involved in persisting a destination endpoint.

**Figure 23:** *Overview of Persisting a Destination Endpoint*

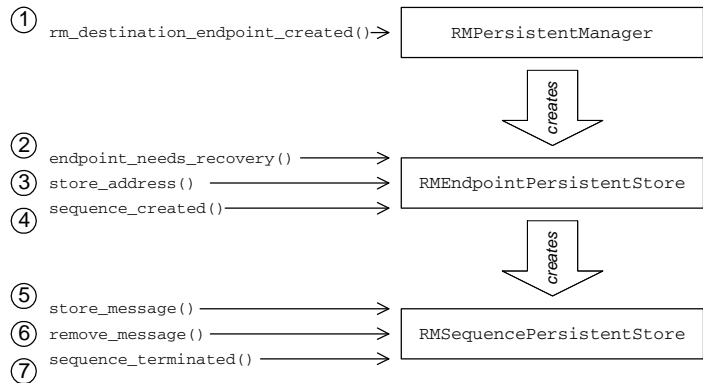

### Persistence steps for a destination endpoint

The steps shown in [Figure 23](#) for persisting a destination endpoint can be explained as follows:

Stage	Description
1	After a WS-RM destination endpoint is created, the WS-RM core calls <code>rm_destination_endpoint_created()</code> on the <code>RMPersistentManager</code> object, in order to create an instance of a destination endpoint in the persistent store.
2	The WS-RM core calls <code>endpoint_needs_recovery()</code> to discover whether there are any undelivered messages from a previous run of the program (that is, whether the program previously crashed).  In the current example, we presume the function returns <code>false</code> , so that the destination endpoint operates in normal mode.
3	After the destination endpoint is activated, the WS-RM core calls <code>store_address()</code> to store the URL address for this endpoint.
4	When the destination endpoint initiates a WS-RM message sequence, the WS-RM core calls <code>sequence_created()</code> on the <code>RMEndpointPersistentStore</code> object. This call is made after receipt of the <code>CreateSequence</code> message, but before sending the <code>CreateSequenceResponse</code> message.
5	When the destination endpoint receives a message from the transport layer, the WS-RM core saves the message to the persistent store by calling <code>store_message()</code> on the <code>RMSequencePersistentStore</code> object.  If the message duplicates a message already present in the persistent store, the <code>store_message()</code> function would return <code>false</code> , indicating that save operation failed.  After the message is persisted, the WS-RM core is ready to send an acknowledgement of the message.
6	After the successful delivery of a message to the Application Destination, the WS-RM core deletes the message from the persistent store by calling <code>remove_message()</code> on the <code>RMSequencePersistentStore</code> object.

Stage	Description
7	After the destination endpoint receives the <code>TerminateSequence</code> message, the WS-RM core calls <code>sequence_terminated()</code> on the <code>RMSequencePersistentStore</code> object.

## Recovery of a Destination Endpoint

### Overview

This subsection describes the typical interaction between the WS-RM core and a WS-RM persistence plug-in, where the destination endpoint is attempting to recover after a program crash.

Figure 24 gives a schematic overview of the steps involved in recovering a destination endpoint.

**Figure 24:** *Overview of Recovering a Destination Endpoint*

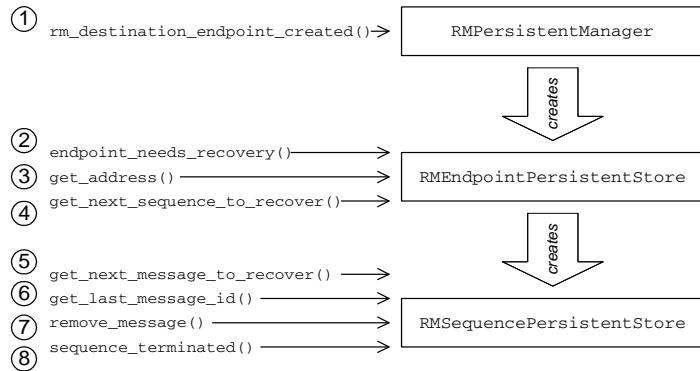

### Recovery steps for a destination endpoint

The steps shown in [Figure 24](#) for recovering a destination endpoint can be explained as follows:

Stage	Description
1	When a program initiates recovery after a crash, the WS-RM core calls <code>rm_destination_endpoint_created()</code> on the <code>RMPersistentManager</code> object to obtain a reference to an <code>RMEndpointPersistentStore</code> object.
2	The WS-RM core calls <code>endpoint_needs_recovery()</code> on the destination endpoint, to determine whether or not this endpoint needs to be recovered.  In the current example, we presume the function returns <code>true</code> , so that the destination endpoint operates in recovery mode.
3	The WS-RM core calls <code>get_address()</code> to recover the address URL previously stored in the database. Artix then activates the destination endpoint using this address.
4	On each of the endpoints to be recovered, the WS-RM core iteratively calls <code>get_next_sequence_to_recover()</code> in order to obtain a list of message sequences to recover (where each message sequence is represented by an <code>RMSequencePersistentStore</code> object).
5	For each sequence, there are two categories of message to recover: <ul style="list-style-type: none"> <li>• Messages received but not delivered (these are stored in the database).</li> <li>• Messages not received at all.</li> </ul> To obtain the list of messages received but not delivered, the WS-RM core iteratively calls <code>get_next_message_to_recover()</code> on the sequence.

Stage	Description
6	<p>To determine which messages have not been received at all, the WS-RM core calls <code>get_last_message_id()</code>. Assuming that the <code>InOrder</code> delivery assurance is in force, we know that all of the messages up to and including the last message ID have been received and delivered.</p> <p>For example, if the last message ID is 25 and the database contains one undelivered message with message ID 33, the destination endpoint can assemble the following ranges to send in a WS-RM acknowledgement message:</p> <pre>[(1,25), (33,33)]</pre>
7	<p>After each message is successfully delivered to the Application Destination, the WS-RM core deletes the message by calling <code>remove_message()</code>.</p>
8	<p>After all of a sequence's messages have successfully reached the Application Destination, the WS-RM core calls <code>sequence_terminated()</code> on the relevant <code>RMSequencePersistentStore</code> object.</p>



---

# Implementing a WS-RM Persistence Plug-In

---

## Overview

This section gives a brief outline of the steps required to implement a WS-RM persistence plug-in, as follows:

- [Implementation steps.](#)
  - [Registering the persistent manager.](#)
  - [Plug-in init\(\) function.](#)
- 

## Implementation steps

To implement a WS-RM persistence plug-in, perform the following steps:

Step	Action
1	Implement the persistent manager class by defining a class that inherits from <code>IT_Bus::RMPersistentManager</code> (which is declared in the <code>it_bus_pdk/rm_persistence.h</code> header file).
2	Implement the endpoint persistent store class by defining a class that inherits from <code>IT_Bus::RMEndpointPersistentStore</code> . (which is declared in the <code>it_bus_pdk/rm_persistence.h</code> header file).
3	Implement the sequence persistent store class by defining a class that inherits from <code>IT_Bus::RMSequencePersistentStore</code> . (which is declared in the <code>it_bus_pdk/rm_persistence.h</code> header file).
4	Create an instance of the persistent manager class and register the instance with the Artix endpoint manager factory (see <a href="#">“Registering the persistent manager”</a> on page 227 and <a href="#">“Plug-in init() function”</a> on page 228 for details).

---

## Registering the persistent manager

To initialize the WS-RM persistence feature, you need to register a persistent manager instance with the Artix bus, as shown in [Example 59](#).

### Example 59: *WS-RM Persistent Manager Constructor Function*

```
// C++
RMPersistentManagerImpl::RMPersistentManagerImpl (
    Bus_ptr bus
)
```

**Example 59:** *WS-RM Persistent Manager Constructor Function*

```

{
    EndpointManagerFactory* factory =
        bus->get_pdk_bus()->get_endpoint_manager_factory("wsrm");

    RMEndpointManagerFactory* rm_endpoint_manager_factory =
        IT_DYNAMIC_CAST(RMEndpointManagerFactory*, factory);

    rm_endpoint_manager_factory->register_rm_persistent_manager(
        this
    );
    ...
}

```

The `RMPersistentManagerImpl` class is a sample implementation of the `IT_Bus::RMPersistentManager` base class. The class constructor should take an `IT_Bus::Bus` instance as an argument, to provide easy access to the Artix bus instance. Use the Artix bus instance, `bus`, to gain access to the `RMEndpointManagerFactory` instance and then register the WS-RM persistent manager instance by calling the `register_rm_persistent_manager()` function.

**Plug-in init() function**

Call the persistent manager constructor from inside the `bus_init()` function, as shown in [Example 60](#).

**Example 60:** *Implementation of the Plug-In's init() Function*

```

// C++
void
RMPersistenceBusPlugIn::bus_init(
) IT_THROW_DECL( (Exception) )
{
    m_persistent_factory =
        new RMPersistentManagerImpl(m_bus);
}

```

Where `RMPersistenceBusPlugIn` is an example plug-in class that implements a WS-RM persistence plug-in.

# Index

## A

- activate() function 136, 143
  - and EXTERNALLY\_DRIVEN scenario 150
  - and messaging-style dispatch 159
  - and single-threaded scenario 148
  - MULTI\_THREADED scenario 145
- architecture
  - of Artix transport 135
- asynchronous dispatch policy 154

## C

- ClientTransport
  - connect() function 136
  - disconnect() function 136
  - initialize() function 136
  - invoke() function 136
  - invoke\_oneway() function 161
- ClientTransport class
  - accessing contexts in 161
  - connect() function 161
  - description 137
  - invoke() function 161
  - overview 136
- ClientTransport invoke\_oneway() function 136
- compiling a context schema 59
- connect() function 136, 161
- contexts
  - and transports 161
  - sample schema 58
  - scenario description 57
  - schema, target namespace 58

## D

- deactivate() function 136
- disconnect() function 136
- dispatch() function 153
  - and asynchronous dispatch 154
- DispatchInfo
  - get\_correlation\_id() function 138
- DispatchInfo class
  - and accessing contexts on the server side 163
  - description 138

- is\_oneway() function 165
- provide\_response\_buffer() function 153, 155
- dispatching
  - messaging-style dispatch 158
  - RPC-style dispatch 153, 155

## E

- EXTERNALLY\_DRIVEN policy value 141, 150

## G

- get\_configuration() function 136
- get\_correlation\_id() function 138
- get\_policies() function 139, 142
  - and MULTI\_THREADED policy value 146
  - and RPC-style dispatch 156
  - and the EXTERNALLY\_DRIVEN policy value 151
  - and the SINGLE\_THREADED policy value 148
- example 144

## H

- header contexts
  - sample schema type 58

## I

- initialize() function 136
- invoke() function 136, 161
- invoke\_oneway() function 136, 161
- iostreams 198
- is\_oneway() function 165
- IT\_TRACE 197

## M

- MESSAGING\_PORT\_DRIVEN and MULTI\_INSTANCE scenario 143
- MESSAGING\_PORT\_DRIVEN and MULTI\_THREADED scenario 145
- MESSAGING\_PORT\_DRIVEN and SINGLE\_THREADED scenario 148
- MESSAGING\_PORT\_DRIVEN policy
  - and run() function 136
- MESSAGING\_PORT\_DRIVEN policy value 141

messaging port threading policy  
 EXTERNALLY\_DRIVEN policy value 150  
 MULTI\_INSTANCE policy value 141  
 MULTI\_THREADED policy value 141  
 SINGLE\_THREADED policy value 142  
 messaging-style dispatch 158  
 MULTI\_INSTANCE policy value 141  
 MULTI\_THREADED policy  
 and run() function 136  
 MULTI\_THREADED policy value 141

**O**

oneway operations  
 overview 165  
 oneway semantics  
 messaging-style dispatch 166  
 oneways functions  
 and RPC-style dispatch 165  
 ORB plug-ins  
 bootstrapping 39  
 creating a static instance 39

**P**

plug-ins  
 bootstrapping 39  
 policies  
 asynchronous dispatch policy 154  
 stack unwind policy 153  
 policy:messaging\_transport:concurrency configuration  
 variable 147  
 policy:messaging\_transport:min\_threads configuration  
 variable 144  
 port  
 in transport architecture 135  
 printf 197  
 provide\_response\_buffer() function 153, 155

**R**

requires stack unwind policy  
 and messaging-style dispatch 159  
 RPC-style dispatch 153, 155  
 and oneway semantics 165  
 run() function 136  
 and thread safety 147  
 MULTI\_THREADED scenario 145

**S**

sample context schema 58  
 schemas  
 context, example 58  
 send() function 136, 153  
 accessing contexts 164  
 and messaging-style dispatch 158, 166  
 implementing 160  
 ServerTransport  
 activate() function 136, 145  
 deactivate() function 136  
 get\_configuration() function 136  
 run() function 136, 145  
 send() function 136  
 shutdown() function 136  
 ServerTransport class 136  
 activate() function 143, 148, 150  
 description 138  
 run() function 147  
 send() function 153  
 shutdown() function 136  
 SINGLE\_THREADED policy value 142  
 SOAPHeaderInfo type 58  
 stack unwind policy 153

**T**

target namespace  
 for a context schema 58  
 threading policies  
 setting 144  
 threading resources policy  
 EXTERNALLY\_DRIVEN policy value 141  
 MESSAGING\_PORT\_DRIVEN policy value 141  
 thread pool  
 configuring for a MULTI\_INSTANCE transport 144  
 configuring for MULTI\_THREADED transports 147  
 thread safety 147  
 trace level 197  
 TRACELOGBUFFER 198  
 TRACE macros 197  
 transport\_activated() function 138  
 transport architecture 135  
 TransportCallback  
 dispatch() function 154  
 transport\_activated() function 138  
 transport\_deactivated() function 138  
 transport\_shutdown() function 138  
 TransportCallback class

- description 138
- dispatch() function 153
- transport\_deactivated() function 138
- TransportFactory
  - get\_policies() function 139
- TransportFactory class
  - description 137
  - get\_policies() function 142, 146
- TransportPolicyList class

- and threading policies 141
  - description 139
  - setting policies 153
- transport\_shutdown() function 138

## W

- wsdltocpp compiler 59

