



Enterprise Analyzer 5.0

Installation Guide

Micro Focus
The Lawn
22-30 Old Bath Road
Newbury, Berkshire RG14 1QN
UK
<http://www.microfocus.com>

© Copyright 2009-2019 Micro Focus or one of its affiliates.

MICRO FOCUS, the Micro Focus logo and Enterprise Analyzer are trademarks or registered trademarks of Micro Focus or one of its affiliates.

All other marks are the property of their respective owners.

2019-06-07

Contents

Overview	4
Installation Tasks	4
Deployment	4
Mainframe and Network Server	5
Repository Server	5
EA Server	5
EA Client	5
Single User Installation	5
Database Setup	6
DB2 User Privileges	6
Oracle User Privileges	7
SQL Server Database Setup	7
Hardware and Software Requirements	10
Repository Server Hardware Requirements	10
Repository Server Software Requirements	10
EA Server Hardware Requirements	10
EA Server Software Requirements	11
EA Client Hardware Requirements	12
EA Client Software Requirements	12
EA Performance Optimization Guidelines	14
Choosing Hardware Configuration	14
Single User (One Machine)	14
Enterprise Installation (Multiple Users Using Separate Database Server)	15
Software Configuration	18
Verification Information	18
Parallel Verification	18
Choosing the Optimal Number of Queue Processors	18
Using More Computers	19
Installing and Uninstalling Enterprise Analyzer	20
Installing the Database Client	20
Installing the Oracle Client	20
Installing the DB2 Client	21
Installing EA on the Server or Client	22
Uninstalling Enterprise Analyzer	22
Post-Installation Administrative Tasks	23
Configuring Enterprise Analyzer	23
Licensing	23
Upgrading Customers	23
Concurrent Use	23
Enterprise Analyzer Licensing	24
Business Rule Manager Licensing	24
Configuring an ODBC Data Source Name	24
Configuring an Oracle ODBC Data Source Name	24
Configuring a DB2 ODBC Data Source Name	25
Creating a Shared Folder for Workspaces	26
Upgrading Workspaces	26
Troubleshooting the Installation	28
Troubleshooting Oracle Errors	28
"There were errors during Index Preparation."	28
Troubleshooting Workspace Access	29

Overview

This manual describes how to install and configure Micro Focus Enterprise Analyzer (EA), a suite of software products for analyzing and modernizing legacy applications.

Enterprise Analyzer provides insight into the technical reality of complex application portfolios, including

- Tools for application and program level understanding, utilizing extensive metrics, reports, diagrammatic views and querying tools to support myriad of business initiatives.
- Quality Assessment with standard code quality queries to serve as a guidance to a code quality practice in both development and maintenance phases.
- Portability Assessment to help you generate various HTML reports to identify points of interest for migrations.
- In depth analysis tools to promote efficiency in the performance of daily tasks such as field changes, understanding of data propagation through a program, and dead code removal.

Business Rule Manager mines business logic from program code and encapsulates the logic in business rules.

While all products are installed with Enterprise Analyzer, each product is licensed separately.

EA is deployed in a multi-user environment with access to a common repository of application objects. Repository setup is the responsibility of a master user, leaving team members free to focus on their tasks. The database for the repository is assumed to be the customer's own.

EA installations consist of the following components:

- The EA Server which hosts EA workspace files and related support files.
- EA Clients which host the link files used to connect to workspaces on the server.

Installation Tasks

The table below describes the tasks involved in installing Enterprise Analyzer and the order in which the tasks must be performed.

Task	Order	Notes
Install Database Client	1	The EA package installs SQL Server Express. This is enough for a small sized repository (up to 10 GB). Beyond that, an Oracle or DB2 database client must be installed wherever the EA client or EA server is installed. Install only if the database client is not already installed.
Install EA on Server	2	
Install EA on Clients	3	

Each task is described and explained in the chapters of the *Installation Guide*.

Deployment

The figure below shows the standard EA deployment scenario. The role each machine performs and its key relationships are described in the following sections.

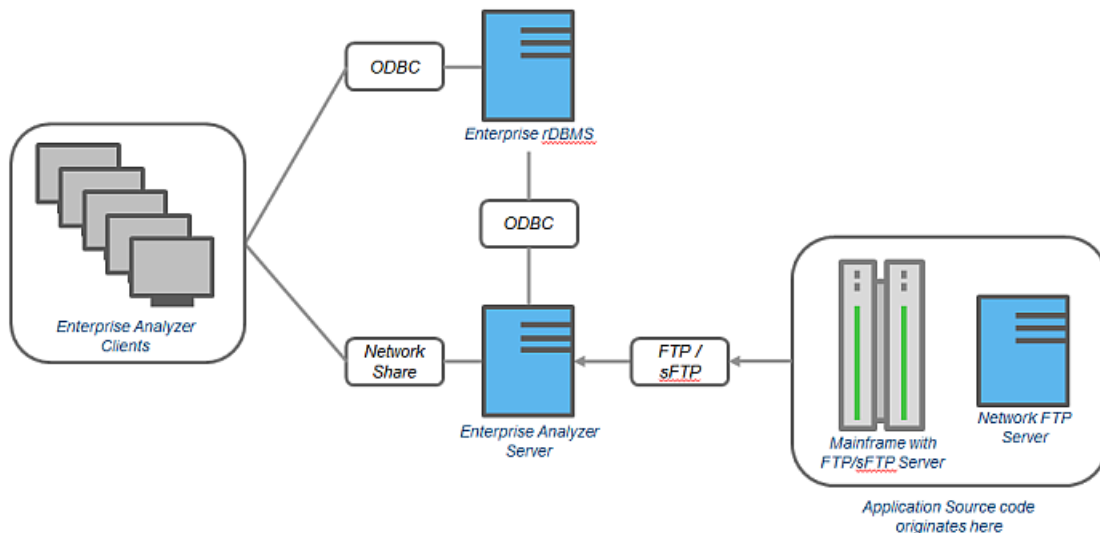

Mainframe and Network Server

The mainframe typically hosts the application to be modeled in EA. Application source files are downloaded from the mainframe (and, if necessary, a network server) to the EA server via FTP or SFTP.

Repository Server

The Repository Server hosts the database for one or more multiuser repositories, one repository per EA workspace. This server provides centralized, network-accessible storage for parsed data and analysis output.

EA Server

The EA Server hosts workspaces, workspace support files (including the copies of application source files EA creates at workspace loading), and workspace output. This server leverages multiple processes to enhance parsing performance in online or batch mode.

Parsed data is sent via ODBC to the repository server. Some analysis output is stored on the EA server as well.

 **Note:** In a multi-user environment, the EA Server cannot reside on the same machine as the EA Repository. The installation program is the same for the EA client and EA server.

EA Client

EA Clients host the link files that let team members connect to workspaces on the EA server. These clients access repository data stored in the repository server via ODBC.

 **Note:** The installation program is the same for the EA client and EA server.

Single User Installation

You can configure Enterprise Analyzer to build a workspace on one machine for a single user. You can use Microsoft SQL Server Express - installed by default - to create a workspace on your local machine. EA creates a database for the workspace "on the fly," with no intervention on your part. If you do use SQL Server Express, bear in mind that the Windows user who creates the workspace must have been configured with appropriate permissions in SQL Server Express. The user who installed SQL Server

Express will always have the appropriate permissions. See the SQL Server Express documentation for configuration instructions.



Restriction: The database size limit when using the SQL Server Express option is 10 GB.

Database Setup

If you use Oracle or DB2, your DBA must set up a schema for each repository you plan to create. Each EA user who accesses the repository must supply credentials for a database user with appropriate access privileges to the repository.

If you use Microsoft SQL Server, the DBA must set up a SQL Server database for each workspace repository you plan to create. EA users typically supply Windows credentials to access the repository.

DB2 User Privileges

If your site uses a DB2 database, your DBA must set up a database schema for each repository you plan to create. Use the scripts provided with EA to create the DB2 database and tablespace, and the required schemas. The scripts are located in the `[Enterprise Analyzer_Installation_Directory]\DB2 Scripts` folder.

Creating a Database and Tablespace

Run the following scripts provided with EA to create the DB2 database and tablespace. Open the `[Enterprise Analyzer_Installation_Directory]\DB2 Scripts` folder:

1. Double-click `[Enterprise Analyzer_Installation_Directory]\DB2 Scripts \crtmwdb.cmd` to create the database.
2. Open `[Enterprise Analyzer_Installation_Directory]\DB2 Scripts\crttblspace.cmd` in an editor. Replace `[ADMINISTRATOR_USER_ NAME]` and `[PASSWORD]` with the user name and password of a user with administrative privileges for the database. Save and close the file.
3. Double-click `[Enterprise Analyzer_Installation_Directory]\DB2 Scripts \crttblspace.bat` to create the tablespace.

Modify the database (`mwdb`), buffer pool (`mwbpb`), and tablespace (`mwtblsp`) names (optional). Modify the names in any scripts that reference them.



Note: The tablespace page size must be 32K. To improve the performance (optional) specify a second tablespace for use in storing database indexes. Users specify both tablespaces when they create an EA workspace. For instructions on how to create a workspace, see *Getting Started* in the EA documentation set.

Creating a Schema

Set up a DB2 schema for each repository you plan to create. Run the following scripts provided with EA to create a schema. In the `[Enterprise Analyzer_Installation_Directory]\DB2 Scripts` folder:

1. Open `crtschema.cmd` in an editor. Replace `[ADMINISTRATOR_USER_ NAME]` and `[PASSWORD]` with the user name and password of a user with administrative privileges for the database. Replace each instance of `[SCHEMA_NAME]` with the name of the schema and `[USER_NAME]` with the database user name. Save and close the file.
2. Double-click `crtschema.bat` to create the schema.

Repeat these steps for each schema you need to create.

Each EA user who accesses a repository must supply credentials for a database user with appropriate access privileges to the schema. These credentials are typically those for the Windows domain user. The table below shows the required privileges.

Type	Privilege
Database Privileges	BINDADD CREATETAB CONNECT IMPLICIT_SCHEMA
Schema Privileges	CREATEIN DROPIN ALTERIN
Tablespace Privileges	USE OF

Oracle User Privileges

If your site uses an Oracle database, your DBA must set up a database schema for each repository you plan to create. Each EA user who accesses the repository must supply the name and password of a database user with appropriate access privileges to the schema. The table below shows the required privileges.

Type	Privilege
Roles	GATHER_SYSTEM_STATISTICS (required only for Compute Database Statistics method. See <i>Getting Started</i> in the EA documentation set.)
System Privileges	ALTER SESSION CREATE SESSION CREATE PROCEDURE CREATE SEQUENCE ALTER ANY SEQUENCE CREATE SYNONYM CREATE TRIGGER CREATE ANY TABLE DROP ANY TABLE ALTER ANY INDEX CREATE ANY INDEX DROP ANY INDEX [UNLIMITED TABLESPACE]1
Object Privileges	SELECT on SYS.V_\$INSTANCE SELECT on SYS.V_\$SESSION SELECT on SYS.V_\$PARAMETER

SQL Server Database Setup

If you use Microsoft SQL Server, you must set up a SQL Server database for each workspace repository you plan to create. If EA users will connect to the repository through a SQL Server login account, make sure the server authentication property is set to **SQL Server and Windows Authentication mode**, as described below.

The following instructions assume you are using the SQL Server Management Studio tool for SQL Server 2008. The procedure for the SQL Server Management Studio Express tool for SQL Server 2005 is similar.

 **Note:** For Windows XP installations using the Italian locale, you must set the Time format in the Control Panel Regional Language Options to "HH:mm:ss" before attempting to verify an EA workspace with a SQL Server repository. Click **Settings > Control Panel > Regional and Language Options > Customize > Time** and choose "HH:mm:ss" from the **Time format** drop-down.

1. Choose **Start > Programs > Microsoft SQL Server 2008 > SQL Server Management Studio**.
2. In the Connect to Server screen, select:
 - Database engine in the **Server type** drop-down.
 - The server on which you want to create the repository database in the **Server name** drop-down.
 - Windows Authentication in the **Authentication** drop-down.
3. Click **Connect**. The Microsoft SQL Server Management Studio window opens. In the Object Explorer pane, expand the folder for the server. Click Databases and choose **New Database...** from the right-click menu. The New Database window opens.
4. Select the General page. In the **Database name** field, enter the name of the database for the repository. Modify the logical name and initial sizes of the database and log files if needed, then click **OK**. The new database is displayed in the Object Explorer pane.

 **Note:** Check the SQL Server Management Studio documentation for details on other database settings.

5. If EA users will connect to the workspace repository through a Windows user account, skip the remaining steps. If EA users will connect to the workspace repository through an SQL Server login account, click the server name in the Object Explorer pane and choose **Properties** from the right-click menu. The Server Properties window opens.
6. Select the Security page. In the Server authentication area, select **SQL Server and Windows Authentication mode**, then click **OK**.
7. In the Object Explorer pane, click **Security > Logins** and choose **New Login...** from the right-click menu. The Login - New window opens.
8. Select the General page. In the **Login name** field, enter the database login name, then choose **SQL Server authentication**. Enter the password for the database login in the **Password** and **Confirm password** fields, then click **OK**. The new login is displayed in the Object Explorer pane.
9. In the Object Explorer pane, expand the database you created for the workspace repository. Click **Security > Users** and choose **New User...** from the right-click menu. The Database User - New window opens.
10. Select the General page. Define the database user:
 - In the **User name** field, enter the database user name.
 - In the **Login name** field, enter the database login name. Use the browse button to browse for the login name.

 **Note:** You specify the login name, not the database user name, when you create or connect to a workspace, so it is usually best to make the user name and login name the same.

- In the Database role membership pane, check db_owner, then click **OK**. The new user is displayed in the Object Explorer pane.

 **Tip:** You can use the same login and database user for multiple databases/workspaces.

You can configure Enterprise Analyzer to build a workspace on one machine for a single user. You can use Microsoft SQL Server Express - installed by default - to create a workspace on your local machine. EA creates a database for the workspace "on the fly," with no intervention on your part. If you do use SQL Server Express, bear in mind that the Windows user who creates the workspace must have been configured with appropriate permissions in SQL Server Express. The user who installed SQL Server Express will always have the appropriate permissions. See the SQL Server Express documentation for configuration instructions.



Restriction: The database size limit when using the SQL Server Express option is 10 GB.

Hardware and Software Requirements

The following sections describe the hardware, disk space, operating system, and software requirements for EA installations.

Repository Server Hardware Requirements

The table below lists the hard drive storage requirements for the Repository Server. For other hardware recommendations, check with support services.

Type	Requirement	Notes
Hard Drive Storage	Variable	Minimum of 20 GB disk space needed for the software installation of the RDBMS and the EA template database. Plus approximately 60x the size in bytes of the application source code modeled in EA (e.g., 100 MB source = 6 GB).

Repository Server Software Requirements

The table below lists the software requirements for the Repository Server.

Type	Requirement
SQL Server	MS SQL Server 2012, 2014, 2016 or 2017
Oracle	Oracle 10g, 11g  Note: If you run the Batch Refresh Process (BRP) on the repository server, Oracle must be .NET-enabled. Oracle requirements for local BRP execution are as follows: <ul style="list-style-type: none">For Windows Server 2008, Oracle 10g, Fix Pack 3, Oracle 11gFor Windows 7, Oracle 11g
DB2	DB2 9.5

EA Server Hardware Requirements



The table below lists the hardware requirements for EA Server installations. Hardware requirements may vary depending on the size of the application you are analyzing.

Type	Requirement	Notes
Processor	2.6 GHz Dual Core or 2x 3.0+ GHz Processors	Dual processing capability with multiple cores in a processor or separate physical processors.
Physical Memory	3 GB RAM	
Virtual Memory	1 GB to 3 GB	

Type	Requirement	Notes
Hard Drive Storage	Variable	<p>For EA workspaces, approximately 40x size in bytes of the application source code modeled in EA (for example, 100 MB source = 4 GB).</p> <p>For EA software, minimum 200 MB.</p> <p>For database client, minimum 200 MB.</p>

EA Server Software Requirements

The table below lists the software requirements for EA Server installations.

Type	Requirement
Operating System	<p>Microsoft Windows Server 2008, 32-bit and 64-bit</p> <p>Microsoft Windows Server 2012, 32-bit and 64-bit</p> <p>Microsoft Windows Server 2016, 32-bit and 64-bit</p> <p>Microsoft Windows 7, 32-bit and 64-bit</p> <p>Microsoft Windows 8, 32-bit and 64-bit</p> <p>Microsoft Windows 10, 32-bit and 64-bit</p>
Database Client	<p>For Oracle or DB2, one configured ODBC data source name (DSN) per database instance. The database client must be .NET-enabled. Oracle database client requirements are as follows:</p> <ul style="list-style-type: none"> For Windows Server 2008, Oracle 10g, Fix Pack 3, Oracle 11g For Windows 7, Oracle 11g
Pre-Requisite Software	<p> Note: The pre-requisite software is automatically installed by the installer.</p> <ul style="list-style-type: none"> Windows Installer 4.5 Sentinel RMS License Manager .NET Framework 3.5 Service Pack 1 <p> Note: On Windows Server 2008 and Windows Server 2012, .NET Framework is a feature and installing it is different from that on older versions. For information on how to enable it, see the Microsoft Support Blog.</p> <ul style="list-style-type: none"> .Net Framework 4.0 Visual C++ 2012 Redistributable 11.0.61030 Visual C++ 2017 Redistributable 14.11.25325.0 SQL Server 2014 Express (optional install) Apache Tomcat 7.0.62 (optional). Needed for EA Web deployment.
Internet Explorer 6.0 or higher (optional)	Required to view HTML report outputs.
Microsoft Office (optional)	Required by EA tools with reporting capabilities to save to Microsoft Office file formats. Excel is required for standard deviation charts in the Executive Report.
Microsoft Visio (optional)	Required to generate output as Microsoft Visio .VSD files.

Type	Requirement
	 Note: Visio .VDX files are XML-based and may be generated without Visio being installed on the EA client.
OpenJDK JRE 8.0 or higher (optional)	Required for Java parsing.



EA Client Hardware Requirements

The table below lists the hardware requirements for EA Client installations. Hardware requirements may vary depending on the size of the application you are analyzing.

Type	Requirement	Notes
Processor	3.0 GHz Processor	Single processor (single or dual core).
Physical Memory	1GB RAM	
Virtual Memory	1GB to 3GB	
Hard Drive Storage	Variable	For EA software, minimum 200MB. For database client, minimum 200MB.

EA Client Software Requirements

The table below lists the software requirements for EA Client installations.

Type	Requirement
Operating System	Microsoft Windows Server 2008, 32-bit and 64-bit Microsoft Windows Server 2012, 32-bit and 64-bit Microsoft Windows Server 2016, 32-bit and 64-bit Microsoft Windows 7, 32-bit and 64-bit Microsoft Windows 8, 32-bit and 64-bit Microsoft Windows 10, 32-bit and 64-bit
Database Client	For Oracle or DB2, one configured ODBC data source name (DSN) per database instance. The database client must be .NET-enabled. Oracle database client requirements are as follows: <ul style="list-style-type: none"> For Windows Server 2008, Oracle 10g, Fix Pack 3, Oracle 11g For Windows 7, Oracle 11g
Pre-Requisite Software	 Note: The pre-requisite software is automatically installed by the installer. <ul style="list-style-type: none"> Windows Installer 4.5 Sentinel RMS License Manager .NET Framework 3.5 Service Pack 1  Note: On Windows Server 2008 and Windows Server 2012, .NET Framework is a feature and installing it is different from that on older versions.

Type	Requirement
	<p>For information on how to enable it, see the Microsoft Support Blog.</p> <ul style="list-style-type: none"> • .Net Framework 4.0 • Visual C++ 2012 Redistributable 11.0.61030 • Visual C++ 2017 Redistributable 14.11.25325.0 • SQL Server 2014 Express (optional install)
Internet Explorer 6.0 or higher (optional)	Required to view HTML report outputs.
Microsoft Office (optional)	Required by EA tools with reporting capabilities to save to Microsoft Office file formats. Excel is required for standard deviation charts in the Executive Report.
Microsoft Visio (optional)	<p>Required to generate output as Microsoft Visio .VSD files.</p> <p> Note: Visio .VDX files are XML-based and may be generated without Visio being installed on the EA Client.</p>
OpenJDK JRE 8.0 or higher (optional)	Required for Java parsing.

EA Performance Optimization Guidelines

This section describes the optimal performance environments in which to run Enterprise Analyzer, including selecting the right hardware configuration for specific types of usage, and optimizing the EA configuration for the selected configuration. The suggestions for performance improvements are focused on the repository build phase of the workspace.

The most time-consuming and hardware-intensive aspects of running Enterprise Analyzer are the source verification and database loading during the workspace build phase. The guidelines include suggestions for improving performance by using multiple Queue Processors and taking advantage of multiple CPU cores, using the parallel verification option which determines the number of used Queue Processors, and guidelines for defining the number of Queue Processors needed for a given configuration of available machines and database server power.

There are two deployment scenarios for Enterprise Analyzer:

- Single User - this is typically a mobile user, such as a consultant on a laptop, who uses the repository for demonstration or assessment purposes.
- Enterprise Installations - several computers are used (one for a database server, one for workspace and multiple user machines).

Choosing Hardware Configuration

Single User (One Machine)

Minimum Hardware Requirements

Type	Requirement	Notes
Processor	1.8 GHz, minimum dual core	
Physical Memory	2 GB RAM	
Hard Drive Storage	HDD with at least 20 GB free space	For EA workspaces, approximately 60x size in bytes of the application source code modeled in EA (for example, 100 MB source = 6 GB).

With this minimum hardware configuration you can run Enterprise Analyzer and analyze sources.

Suggested Upgrades

The analysis time increases when the number of analyzed sources rises. To reduce the analysis time we recommend you use one of the suggested upgrades:

1. A high speed Solid State Drive (SSD) for storing database tables. This can be added as an external drive; however USB 3.0 or eSATA must be used. This will improve the verification performance by 25% over the minimum configuration.
2. Use a quad core processor such as Intel Core i7 2670QM or any other quad core QE/QM processor. This improves the verification performance by 50% over the minimum system configuration.



Note: You must run additional Queue Processors to benefit from the additional cores. See the *Choosing the Optimal Amount Of Queue Processors* section for details.



Note: Improved verification performance means that if the project verification takes 100 minutes, and you get 33% performance improvement, the verification time is reduced to 67 minutes.

Recommended Configuration 1

This configuration gives 33% improved verification performance. The changes from the minimum configuration are marked in bold.

Type	Requirement	Notes
Processor	2.0 GHz, 2 cores	
Physical Memory	4 GB	
Hard Disk Drive	SSD with at least 20 GB free space	For EA workspaces, approximately 60x size in bytes of the application source code modeled in EA (for example, 100 MB source = 6 GB).

Recommended Configuration 2

Recommended Configuration 2 gives 50% improved performance of verification. The changes from the minimum configuration are marked in bold.

Type	Requirement	Notes
Processor	2.0 GHz, 4 cores	
Physical Memory	4 GB	
Hard Disk Drive	Any type with at least 20 GB free space	For EA workspaces, approximately 60x size in bytes of the application source code modeled in EA (for example, 100 MB source = 6 GB).

Performance Configuration

The Performance Configuration is a combination of all upgrades. It gives 66% improved verification performance. The changes from the minimum configuration are marked in bold.

Type	Requirement	Notes
Processor	2.0 GHz, 4 cores	
Physical Memory	4 GB	
Hard Disk Drive	SSD with at least 20 GB free space	For EA workspaces, approximately 60x size in bytes of the application source code modeled in EA (for example, 100 MB source = 6 GB).

Enterprise Installation (Multiple Users Using Separate Database Server)

A typical environment where large projects will be verified on a regular basis usually consists of 3 types of components:

1. Database server (Oracle, DB2, MS SQL Server).

- EA server with the workspace files. This is the machine where EA is installed and where the EA workspace folder is located.

 **Note:** There can be more than one workspace.

- Processing node(s). This is one or more computers running Queue Processors, or hosting the users of the tool.

Database Server

Minimum hardware requirements

Type	Requirement	Notes
Processor	2.6 GHz Dual Core or 2x 3.0+ GHz Processors	Dual processing capability with multiple cores in a processor or separate physical processors.
Physical Memory	3 GB RAM	
Hard Disk Drive		For EA workspaces, approximately 60x size in bytes of the application source code modeled in EA (for example, 100 MB source = 6 GB).

The minimum configuration can be up to four concurrent Queue Processors while providing reasonable response time. To improve performance, one of the following upgrades should be used:

- Use faster storage, for example use SSD or storage arrays in RAID0. SSD improves the performance of verification by 33%. 2x SCSI 15000 rpm gives a similar performance improvement.
- Use 8 GB of RAM. Increasing the amount of RAM improves the performance of verification by 15% when using more Queue Processors.
- Network latency between database server and repository server and users should be less than 1ms.

Recommended hardware configuration

This is the recommended hardware configuration. The changes from the minimum configuration are marked in bold.

Type	Requirement	Note
Processor	2.6 GHz Dual Core or 2x 3.0+ GHz Processors	Dual processing capability with multiple cores in a processor or separate physical processors.
Physical Memory	8 GB RAM	
Hard Disk Drive	SSD or SCSI 15000 rpm in RAID0	For EA workspaces, approximately 60x size in bytes of the application source code modeled in EA (for example, 100 MB source = 6 GB).

Performance Configuration

You get 33% improved performance of verification.

Type	Requirement	Note
Processor	Xeon CPU E5310 or Core i7 3770	
Physical Memory	8 GB	

Type	Requirement	Note
Hard Disk Drive	2x SCSI 15000 rpm RAID0 or 240GB SSD	

 **Note:** Performance configuration can support up to 16 concurrent Queue Processors. Note that user activity through the online tool should be counted as an active Queue Processor.

EA and Workspace Server

The repository server stores the Enterprise Analyzer workspace folder and files. It is shared on the network so that other users can access it.

 **Warning:** Micro Focus does not recommend combining the EA server and database server (and even processing node) for machines with limited resources.

Minimum hardware requirements for Repository Server are:

Type	Requirement	Note
Hard Disk Drive	Minimum of 20 GB disk space needed for the software installation of the database software.	For EA workspaces, approximately 60x size in bytes of the application source code modeled in EA (for example, 100 MB source = 6 GB). Storing your workspace on an SSD drive improves verification performance by 5%-15%, depending on your project.

Processing Node/Nodes

This is the machine that runs the Queue Processors and the processes that they kick off. The minimum configuration lets you run a single Queue Processor.

Minimum System Requirements

Type	Requirement
Processor	3.0 GHz single core or 2 GHz dual core
Physical Memory	2 GB
Virtual Memory	1 GB to 3 GB
Hard Disk Drive	1 GB

The minimum system lets you analyze small volumes of sources and use the basic functionality of the tool. To determine the optimal amount of Queue Processors for your Processing node see *Choosing the Optimal Amount of Queue Processors*. To improve the performance, some of the following upgrades can be used:

1. Use more CPUs or CPU cores. Enterprise Analyzer scales very well so the performance improvement matches the CPU cores added - verification performance is improved by 90% when CPU cores are doubled. The limit is eight physical cores that exclude hyper threading, with 16 queue processors. Each concurrent Queue Processor instance needs up to an additional 2GB of RAM. Make sure your database server can support the additional Queue Processors, see *Database Server*.
2. Use more computers as processing nodes.

Recommended Configuration (66% improved performance of verification)

Type	Requirement
Processor	3 GHz quad core CPU
Physical Memory	4 GB
Hard Disk Drive	4 GB

As these processing nodes communicate extensively with the database server, a low-latency network is required between processing node(s) and database server.

 **Note:** For best results, the computers must be on the same local network. You can use a repository server or a database server (or both) as processing nodes, provided that MS Windows is installed.

Software Configuration

Verification Information

Verification is the process of analyzing the code loaded into EA. The verification process demands a lot of CPU power. Enterprise Analyzer is designed to use a single CPU core for the main application, but each Queue Processor can run on a separate CPU core. The Queue Processors can even run on multiple computers to help with the verification database loading. There are two ways of initiating the verification process. The first is the online tool (Enterprise Analyzer) and the second is through the Batch Refresh Process (BRP).

Parallel Verification

By default Enterprise Analyzer uses serial verification both for the online tool and for BRP. If you have a multicore CPU, it is better to use parallel verification.

To enable it in Enterprise Analyzer:

1. Click **Options > Workspace Options**.
2. Click **Verification > Parallel Verification** tab.
3. Select either
 - **Run Parallel Verification in the online tool**
 - **Run Parallel Verification in BRP**
4. Adjust the **Minimum Queue Processors** to improve performance when using an optimized number of CPU cores.

 **Note:** On a quad core CPU you get up to 4 times better performance provided that you use the optimal number of Queue Processors.

Choosing the Optimal Number of Queue Processors

The optimal number of Queue Processors is related to the number of physical CPU cores available.

If you have X physical CPU cores you should use at least X Queue Processors. Using more Queue Processors than physical CPU cores slightly increases performance but depending on your system setup it could also slow down the verification because of the large number of concurrent IO operations.

 **Note:** Micro Focus recommends using <number-of-physical-CPU-cores> multiplied by two.

Using More Computers

You can start a new Queue Processor on another computer to help the current verification.



Note: EA must be installed on the computer that launches a Queue Processor.

1. Open Micro Focus Enterprise Analyzer Administration and click **Administer > Build New Connection**. This creates a local `.rwp` file to connect to the workspace that needs help during the verification and database loading.
2. Click **Administer > Launch Queue Processor**. The Launch Queue Processor window opens.
3. Specify the local `.rwp` file for the workspace and enter the number of Queue Processors that you want to start.

Installing and Uninstalling Enterprise Analyzer

Before running an installation program described in this section, make sure you have administrative permissions for the machine on which you are performing the installation. If you do not have administrative permissions, the installation program will not let you continue.



Note: You can run the Windows Installer (.msi) installation programs "silently." That is particularly useful when you are installing clients on a network. Check with support services for the appropriate sequence of commands.

Installing the Database Client

If you use Oracle or DB2, a database client must be installed wherever the EA client or EA server is installed. If the RDBMS client software is not already installed on your machine, follow the instructions in this section to install it.

Installing the Oracle Client

You will need the following information from your DBA to install and configure Oracle client software:

- The TNS Service Name for the database in which your workspace repositories will be stored.
 - The host name for the computer on which the database resides.
 - The port number for communications with the host, if it is not the standard port number.
 - A database user ID and password.
1. Double-click the `setup.exe` program for the Oracle client installation. The Welcome screen opens.
 2. Click **Next**. The Select Installation Type screen opens. Select Custom.
 3. Click **Next**. The Specify Home Details screen opens. Enter an alternate name and path for the installation, if desired. Otherwise, accept the defaults.
 4. Click **Next**. The Available Product Components screen opens. Select the following components:
 - SQL *Plus
 - Oracle JDBC/THIN Interfaces
 - Oracle Windows Interfaces. Deselect every choice under Oracle Windows Interfaces except Oracle ODBC Driver.
 - Oracle Call Interface (OCI)
 - Oracle Net
 5. Click **Next**. The installer checks for prerequisites to ensure your environment meets the minimum requirements for installation. Resolve any flagged items, if necessary.
 6. Click **Next**. Review the Summary screen to confirm your selections. Use the Back button to correct any errors. When you are satisfied that all the information is correct, click **Install**.
 7. When installation completes, the Oracle Net Configuration Assistant is launched.
 8. Click **Next**. The Naming Methods Configuration screen opens. Verify that Local Naming is shown in the Selected Naming Methods field.
 9. Click **Next**. The Net Service Name Configuration screen opens. In the **Service Name** field, enter the TNS Service Name for the database your workspace repositories will be stored in. This name is provided by your DBA.

10. Click **Next**. The Select Protocols screen opens. Select TCP.
 11. Click **Next**. The TCP/IP Protocol screen opens. Enter the host name for the computer on which the Oracle database resides. This name is provided by your DBA. Use the standard port number of 1521 unless otherwise instructed by your DBA.
 12. Click **Next**. The Test screen opens. Select **Yes, perform a test**.
 13. Click **Next**. You should receive a message that the test did not succeed. This is because the default login used for the test is the Oracle SYSTEM login. You must change the user name and password to those provided by your DBA.
 14. Click **Change Login**. In the Change Login dialog, enter the user ID and password provided by your DBA.
 15. Click **OK**. You should now receive a message that the connection test was successful. If the test remains unsuccessful, click **Change Login** and confirm that you entered the correct credentials as provided by your DBA. If problems persist, contact your DBA for assistance.
 16. Click **Next**. The Net Service Name screen opens.
 17. The **Net Service Name** field is prefilled with the TNS Service Name you specified in Net Service Name Configuration screen. Click **Next**. The Additional Net Service Names screen opens.
 18. In the Additional Net Service Names screen, configure additional TNS Service Names, one per database instance you need to connect with. This step is optional. Select **Yes** to configure additional TNS Service Names. Select **No** to complete the configuration.
-  **Note:** If you need to connect to additional database instances at a later date, you can add TNS Service Names by manually editing the `tnsnames.ora` file in `Repository_Client_HOME`. See your DBA for details.
19. Click **Next**. Then click **Next** on the following two screens to complete the Oracle Net Configuration.
 20. On the Oracle Net Configuration completion screen, click **Finish** to exit the Net Configuration Assistant.
 21. The Oracle Installer window opens. Click **Exit**. You are prompted to confirm that you want to exit. Click **Yes**.

Installing the DB2 Client

Follow the instructions in this section to install the DB2 client.

 **Note:** The DB2 client must be .NET-enabled. Choosing the Typical DB2 client installation ensures that .NET support is available.

1. Double-click the `setup.exe` program for the DB2 client installation. The Welcome screen opens. Click **Install a Product**.
2. A screen prompts you to select the product you want to install. Under IBM Data Server Client, click **Install New**.
3. The DB2 Setup Wizard opens. Click **Next**.
4. The Software License Agreement screen opens. Read the License Agreement carefully. Click **I accept the terms in the license agreement** to accept its terms, then click **Next**.
5. A screen prompts you to select the installation type. Select **Typical**, then click **Next**.
6. A screen prompts you to install the IBM Data Server Client. Select **Install IBM Data Server Client on this computer**, then click **Next**.
7. A screen prompts you to select an installation folder. To accept the prefilled value, click **Next**. To specify a different folder, click **Change** and follow the substeps below.
 - a) Navigate the folder structure to find a suitable location. If the destination folder does not exist, the installation creates it.
 - b) Click **OK** to exit the screen and return to the installation folder screen.
 - c) Click **Next** in the installation folder screen.

8. A screen prompts you to enable operating system security for DB2 objects. Unless otherwise instructed by your system or database administrator, deselect **Enable operating system security**, then click **Next**.
9. A screen prompts you to start copying installation files to your computer. Click **Install** to begin transferring files to your machine. A progress meter indicates the progress of the transfer.
10. When the transfer is complete, a screen informs you that setup is complete. Click **Next**.
11. A screen prompts you to install additional products. Click **Finish**.

Installing EA on the Server or Client

The EA Server hosts EA workspace files and related support files. EA Clients host the link files used to connect to workspaces on the server. Follow the instructions in this section to install EA on the client or server. The Micro Focus License Manager is packaged with the installation.



Note: Having the EA server and the database on separate machines could improve performance. The installation program is the same for the EA client and EA server.

1. Double-click `EnterpriseAnalyzer.exe`. Note that there might be a version number in the name of the `.exe` file.
2. Change the installation directory if not installing to the default location.
3. Select which optional installs you want to include:
 - Microsoft SQL Server - Express Edition
 - Web Client
 - Micro Focus MFA
 - Micro Focus Enterprise Analyzer Administration Tool (needed for server, not really needed for client).
4. Read the End User License Agreement and check **I agree to the End User License Agreement**.
5. Click **Install**.

Uninstalling Enterprise Analyzer

Follow the instructions below to uninstall an Enterprise Analyzer product. Make sure you close any open EA programs before running the uninstall program.

1. Click **Start > Control Panel > Programs > Programs and Features > Uninstall a program**
2. In the **Uninstall or change a program** window, right-click the product you want to uninstall, then click **Uninstall**. You are prompted to confirm that you want to uninstall the product. Click **Uninstall**.

Post-Installation Administrative Tasks

Before you can work in Enterprise Analyzer, you must complete the basic administrative tasks described in this section. You are prompted to perform the first of these tasks, configuring the EA, when you complete the installation.

Configuring Enterprise Analyzer

Use the Configuration Manager in the Enterprise Analyzer Administration tool to configure EA options and displays for the programming languages, dialects, character sets, and products in use at your site.

If you configure your EA for COBOL, for example, you will see only the EA options and displays appropriate for COBOL modernization. You need to configure your EA for PL/I as well, you can come back to the Configuration Manager later and select PL/I in addition to COBOL.

1. Open the Configuration Manager window.

- If you are installing EA, the Configuration Manager window opens after you finish the installation.
- If you have previously installed EA and want to reconfigure it, choose **Start > Programs > Micro Focus > Enterprise Analyzer > Enterprise Analyzer Administration**. The Enterprise Analyzer Administration window opens. In the **Administer** menu, choose **Configure Micro Focus Enterprise Analyzer**. The Configuration Manager window opens.



Note: If EA is open, you are prompted to exit. Click **OK**, then close EA.

- ### 2. Select each programming language, dialect, and character set in use at your site. Select each EA product you want to use at your site. The core Application Analyzer product is always selected. Select **Additional Tools** to enable tools not used in typical EA configurations. When you are satisfied with your choices, click **OK**.



Note: If you modify your EA configuration, make sure you upgrade workspaces created under the previous configuration.

Licensing

Although Enterprise Analyzer and Business Rule Manager) are both installed by the Enterprise Analyzer installer, each product is licensed separately. Follow the instructions in the topics listed below to manage your licenses.

Upgrading Customers

A customer upgrading from Modernization Workbench version 3.1 or later may use the existing license key to enable Enterprise Analyzer for the same number of users.

Concurrent Use

You can license Enterprise Analyzer and Business Rule Manager for concurrent use. In this mode, one license key for the purchased number of end users will be registered to a license server and each user instance will contact it for authorization.

Enterprise Analyzer Licensing

A Sentinel RMS license server is installed with Enterprise Analyzer.

Depending on the licensing model in use at your site, you can manage your license:

- Locally, using the installed Sentinel RMS license server.
- Remotely, using a Sentinel RMS license server that has been configured to manage licenses centrally.



Note: The remote license server uses the same software as the local license server that is installed with Enterprise Analyzer.

You will need to apply a license in the Micro Focus License Administration to use Enterprise Analyzer. To start the Micro Focus License Administration, choose **Start > All Programs > Micro Focus License Manager > License Administration**.

- If you use a local license server, you can apply a license using an authorization code or a licensing file in the **Install** tab of the License Administration.
 - **Authorization code:** Enter the 16-character license authorization code for Enterprise Analyzer, then click **Authorize**.
 - **Licensing file:** Enter your downloaded license file (.mflic) by browsing or dropping the file, then click **Install Licenses**.
- If you use a remote license server, click **Options > Advanced Configuration**, then click **Change** in the **License server** field. Enter the IP address or server name of the license server, then click **Save**.

Your License System Administrator can tell you which licensing model your site uses and provide you with the name of the remote license server if needed. For complete information, including how to configure a remote license server, refer to the help provided with the License Administration tool.

Business Rule Manager Licensing

Trial licenses are not provided for Business Rule Manager. Before you can work with it, you must enter the 16-character license authorization code:

- Choose **Start > Programs > Micro Focus License Manager > License Management System**. In the Licensing System Administration tool, click the **Authorize** tab, then enter the authorization code in the **Enter authorization code** field and click **Authorize**.

Configuring an ODBC Data Source Name

An ODBC data source name (DSN) is a set of credentials for connecting with a database instance. If you use Oracle or DB2, you must configure a DSN for the database that holds your workspace repositories.

Configuring an Oracle ODBC Data Source Name

To configure an Oracle Data Source Name (DSN), you must have specified a TNS Service Name for the database in which your workspace repositories will be stored. This is the TNS Service Name you entered when you installed the repository client.

Check the file `tnsnames.ora` in `Repository_Client_HOME` to make sure the TNS Service Name exists. The entry should look like this, where `RMWPROD` is the TNS Service Name:

```
RMWPROD
  (DESCRIPTION=
    (ADDRESS_LIST=
      (ADDRESS=(PROTOCOL=TCP)(HOST=tiger)(PORT=1521))
    )
    (CONNECT_DATA=
```



```
(SID=lnx)  
)  
)
```

You will also need to obtain a database user ID and password from your DBA to configure the Oracle DSN.



Note: Keep the DSN handy. You will need to specify it when you create an EA workspace. For instructions on how to create a workspace, see **Getting Started** in the EA documentation set.

1. In the Windows Control Panel, double-click **Administrative Tools**. The Administrative tools window opens.
 2. Double-click **Data Sources (ODBC)**. The ODBC Data Source Administrator window opens.
 3. Select the System DSN tab and click **Add**. The Create New Data Source dialog opens.
 4. Select an appropriate Oracle driver and click **Finish**. The Oracle ODBC Driver Configuration window opens.
 5. Specify the following information in the Oracle ODBC Driver Configuration window:
 - In the **Data Source Name** field, enter a name of your choice to identify the data source. If your DBA has supplied a common DSN for use across the enterprise, enter it here.
 - In the **Description** field, enter an optional description for the data source.
 - In the **TNS Service Name** drop-down, select the TNS Service Name for the database in which your workspace repositories will be stored. If no choices are shown, or if you are unsure which name to select, contact your DBA.
 - In the **User ID** field, enter the database user ID supplied by your DBA.
 6. Click **Test Connection**. The Oracle ODBC Driver Connect window opens.
 7. In the Oracle ODBC Driver Connect window the **Service Name** and **User ID** fields are prefilled with the information you supplied in the Oracle ODBC Driver Configuration window. Enter the password for your user ID and click **OK**. You are notified that the connection was created successfully. Click **OK**.
-  **Note:** If you receive an error, verify the driver configuration settings and retest the connection. See your DBA if the problem persists.
8. Click **OK** to exit the Driver Configuration window. Then click **OK** again to exit the ODBC Data Source Administrator window.

Configuring a DB2 ODBC Data Source Name

You will need the following information from your DBA to configure a DB2 ODBC data source name (DSN):

- The name of the database in which your workspace repositories will be stored.
- The host name for the computer on which the database resides.
- The port number for communications with the host, if it is not the standard port number.



Note: Keep the DSN handy. You will need to specify it when you create an EA workspace. For instructions on how to create a workspace, see *Getting Started* in the EA documentation set.

1. In the Windows Control Panel, double-click **Administrative Tools**. The Administrative tools window opens.
2. Double-click **Data Sources (ODBC)**. The ODBC Data Source Administrator window opens.
3. Select the System DSN tab and click **Add**. The Create New Data Source window opens.
4. Select IBM DB2 ODBC DRIVER - DB2COPY1 and click **Finish**. The ODBC IBM DB2 Driver configuration dialog opens.
5. In the **Data Source Name** field, enter a name of your choice to identify the data source. If your DBA has supplied a common DSN for use across the enterprise, enter it here.
6. In the **Description** field, enter an optional description for the data source.
7. In the **Database alias** field, select an existing database alias from the drop-down, then click **OK**.

8. If a database alias has not been defined, click **Add**. The CLI/ODBC Settings window opens.
9. In the Data Source tab, the **Data source name** and **Description** fields are pre filled with the information you supplied in the ODBC IBM DB2 Driver configuration dialog. In the **User ID** field, enter your domain user name. In the **Password** field, enter your domain user password. The fields are case-sensitive.
10. Select the TCP/IP tab and specify the following information:
 - In the **Database name** field, enter the name of the database in which your workspace repositories will be stored.
 - In the **Database alias** field, enter a database alias.
 - In the **Host name** field, enter the host name for the computer on which the database resides.
 - In the **Port number** field, enter the port number for communications with the host. Use the standard port number of 50000 unless otherwise instructed by your DBA.
11. Click **OK**. You are returned to the ODBC Data Source Administrator window. Select the new data source name and click **Configure**. The CLI/ODBC Settings window for the data source opens.
12. In the Data Source tab, the **Data source name** and **Description** fields are pre filled with the information you supplied in the ODBC IBM DB2 Driver configuration dialog. In the **User ID** field, enter your domain user name. In the **Password** field, enter your domain user password. The fields are case-sensitive. Click **Connect** to test the database connection. You are notified that the connection was created successfully. Click **OK**.
 **Note:** If you receive an error, verify the driver configuration settings and retest the connection. See your DBA if the problem persists.
13. Click **OK** to exit the CLI/ODBC Settings window. Then click **OK** again to exit the ODBC Data Source Administrator window.

Creating a Shared Folder for Workspaces

The folder in which you plan to create workspaces must be shared with team members. It is typically more convenient to share the folder before you create workspaces, but you can do it afterward if necessary, then refresh the workspace path as described in *Getting Started* in the EA documentation set.

Follow the instructions below to create a shared folder for workspaces. You must be an administrator to create a shared folder.

1. On the EA server, create a folder for EA workspaces.
2. Select the folder and choose **Sharing and Security** from the right-click menu. The Properties dialog for the folder opens. In the Sharing tab for the Properties dialog, select **Share this folder on the network** (or, on a machine in a Windows domain, **Share this folder**). Enter the share name in the **Share name** field and click **Apply**.
 **Note:** Do not embed spaces in the share name. Doing so may cause other users to be unable to access the folder.
3. Click **Permissions**. The Permissions for Folder dialog opens. Specify the appropriate permissions for users sharing the folder and click **OK**.

Upgrading Workspaces

When you modify your EA configuration, you must upgrade every workspace created with the previous configuration. Only the master user can upgrade a workspace.

1. Choose **Start > All Programs > Micro Focus > Enterprise Analyzer > Enterprise Analyzer Administration**. The EA Administration window opens.
2. In the Administration window, choose **Administer > Upgrade Workspace**. The Upgrade workspace dialog opens.

3. Choose the workspace you want to upgrade, then click **Open**. A Workspace Upgrade window opens.
4. Click **Start** to begin the upgrade. In the Workspace Upgrade window you see the upgrade process (The parts that are being upgraded are highlighted and the checkbox next to each upgraded part is checked when the upgrade is complete.) You can Pause the upgrade and Resume it later.



Note: Upgrades that have stopped due to an error can be reset from the **File** menu.

5. (optional) Click **Workspace Upgrade > File >Export DDL Script** to export the DDL script to perform the upgrade and give it to a DBA.

Troubleshooting the Installation

Follow the instructions in this section to troubleshoot an EA installation.

Troubleshooting Oracle Errors

Follow the instructions in this section to troubleshoot common Oracle errors.

ORA-00958: name is already used by an existing object

This error occurs because the schema for the workspace was created with an Oracle ID already used to create another schema. A unique Oracle ID must be used to create an Oracle schema.

ORA-01034: ORACLE not available; ORA-27101

These errors occur because the Oracle instance is not running. You could be receiving ORA-27101 because you tried to modify database parameters such as SGA size.

"There were errors during Index Preparation."

This error occurs because the Oracle tablespace does not have enough free space to restore the indexes.

To check the space in all tablespaces, run the following query:

```
select
  fs.tablespace_name                                "Tablespace",
  (df.tablespace - fs.freespace)                    "Used MB",
  fs.freespace                                       "Free MB",
  df.tablespace                                       "Total MB",
  round(100 * (fs.freespace / df.tablespace))      "Pct. Free"
from
  (select
    tablespace_name,
    round(sum(bytes) / 1048576) TotalSpace
  from
    dba_data_files
  group by
    tablespace_name
  ) df,
  (select
    tablespace_name,
    round(sum(bytes) / 1048576) FreeSpace
  from
    dba_free_space
  group by
    tablespace_name
  ) fs
where
  df.tablespace_name = fs.tablespace_name
```

To add additional files to the tablespace, use the following command:

```
alter tablespace <name> add datafile 'path\filename.ora' size 100M autoextend
on;
```

Troubleshooting Workspace Access

The folder in which you plan to create workspaces must be shared with team members. If users are unable to access workspaces, it may be because:

- You have not shared the folder for workspaces. Share the folder, then refresh the workspace path as described in *Getting Started* in the EA documentation set.
- You shared the folder for workspaces after creating a workspace. Refresh the workspace path as described in *Getting Started* in the EA documentation set.
- You embedded spaces in the value of the **Share name** field for the folder. Remove the spaces, then refresh the workspace path as described in *Getting Started* in the EA documentation set.